

**THIS YEAR  
BIGGEST SALE**

SEE A LOT OF OTHER  
PROMOTIONS  
IN STORE

SLAYTON 36



**UP TO  
\$600  
OF DISCOUNT**



**SHERBROOKE**  
69, Godin Road  
819 565-7980

## Pierre-Luc Dusseault: one year later

Page 3

# THE RECORD

THE VOICE OF THE EASTERN TOWNSHIPS SINCE 1897



# WEEKEND EDITION

95 CENTS + TAXES

PM#0040007682

FRIDAY, OCTOBER 21, 2016

## Haut-Saint-François prefect steps down

Record Staff  
SHERBROOKE

The Haut-Saint-François MRC is losing its prefect as of November 12, less than a year before next year's general election in November 2017. Nicole Robert will be stepping down from her post for health related reasons.

During her eight years at the head of the MRC, the political climate changed from suspicion and disengagement to collaboration among the 14 municipalities around the MRC council. The mayors are respected in their positions, workshops are organized to deepen understanding of important issues, and there is rarely more than vote, because consensus has become the norm.

In terms of major issues, many have been settled during the. Robert Prefecture. The municipalities and MRC working in tandem, the collaboration of several partners, and the willingness of mayors to chair committees, are all part of the recipe for success she has established. The municipality also saw the emergence of one-stop passenger transport, high-speed Internet for more isolated people, the Valoris sorting center

CONT'D ON PAGE 5

## Soup's On

Anglican "Third Thursday" soup lunch going strong



GORDON LAMBIE

Held every third Thursday of the month in the hall of Saint George's Anglican Church in Lennoxville, the Third Thursday lunch brings together members of communities from across the Saint Francis Deanery for a little bit of fundraising and fellowship. According to Beverly Dame of St. Barnabas church in North Hatley, the event has been going on for three years now. Though originally planned as a fundraiser for refugee sponsorship, Dame said that the money from donations is now given to the general needs of the various worship communities. Pictured here are servers Liz Warlund, Bruno Gnassi, Beverly Dame, Johanne D'Iorio, Jennifer Madill, and Ruth Sheeran.

**MANOIR  
STFRANCIS**

WWW.MANOIRSTFRANCIS.COM  
819.562.0875



**A NICE  
GIFT**  
- IT'S GREAT! -

Choose from one  
of our 3 gifts at  
signing, it's great!  
Value of 800\$ each.

# The Record e-edition

There for you  
24-hours-a-day  
7-days-a-week.  
Wherever you are.

Access the full edition of the *Sherbrooke Record* as well as special editions and 30 days of archives.

Renew or order a new 12-month print subscription and get a 12-month online subscription for an additional \$5 or purchase the online edition only for \$82.21.

Record subscription rates (includes Quebec taxes)

- 1 year print: \$155.91
- 6 month print: \$81.85
- 3 month print: \$41.57
- 12 month web only: \$82.21
- 1 month web only: \$7.46

Web subscribers have access to the daily *Record* as well as archives and special editions.

Subscribing is as easy as 1,2,3:

1. Visit the *Record* website: [www.sherbrooke.com](http://www.sherbrooke.com)
2. Click e-edition.
3. Complete the form and wait for an email activating your online subscription.

## Weather



TODAY:  
PERIODS OF  
RAIN

HIGH 13  
LOW 12



SATURDAY:  
RAIN

HIGH 17  
LOW 3



SUNDAY:  
RAIN

HIGH 7  
LOW 2



MONDAY:  
SHOWERS

HIGH 6  
LOW 0



TUESDAY:  
40% CHANCE  
OF SHOWERS  
OR FLURRIES  
HIGH 4  
LOW -2

# Library news

A week ago, Wednesday 12th, the Adopt-a-Book fundraiser and Ross Murray book launch (re-launch) took place. By our usual standards it was a modest turnout, but any lack of numbers was more than made up for in sheer enthusiasm. Author Murray kept the crowd in the game by reading from and commenting on his latest book and first



## GOOD READS

### LENNOXVILLE LIBRARY

Hi readers, allow me to introduce myself. My name is Shanna Bernier, and I am really looking forward to writing about literature for children and young adults for the Lennoxville Library Good Reads column. I will try to tackle different themes and topics from everyday life, subjects which, with some good kids books as a tool, can develop into more of a constructive conversation and less of a crisis. I hope to also read some of the new and exciting young adults' books available so that you can help your tweens or teens make good reading choices. Who knows, you might even get a few ideas for the Christmas list! First, I should make it clear that I am not an expert. But I am a Mom, an educator, an avid reader, and, most importantly, a great lover of books. I think that books can be amazing tools for parenting and education. They can be a great escape, and they can be a bridge to conversation. Books can be magic.

To dive right in, this month I am going to discuss the perennially challenging topic of "The Birds and the Bees". I have a three-and-a-half-year-old daughter. She is just starting to ask questions about the human body, as well as the ori-

gin of babies. Beatrice gained a baby sister six months ago, and without some excellent story books along the way, some of our conversations could have been awkward. My parenting philosophy is that honesty and truth are important for kids, and I always try to answer questions up front. The key is making the right kind of honest answer for the right age. Beatrice is satisfied for the time being to know babies grow inside a mama's belly. I didn't give her—a three-year-old—a whole biology lesson and sex education class, but I did tell her the truth. I told her facts that she could understand, and I followed her lead. More and more research is suggesting that a healthy relationship with our bodies, along with an attitude of respect and truth, leads to better choices. Children who are treated with respect, and understanding, will be better advocates for themselves later in life. Two books which come highly recommended to help discuss the biology and questions that come up when a new baby is on the way are *What Makes a Baby*, written by Cory Silverberg, and *It's Not the Stork!* A Book about Girls, Boys, Babies, Bodies, Families, and Friends, by Robie H. Harris (both available to Lennoxville Library patrons through inter-library loan).

Our efforts to find a new Library Coordinator continue. As we mentioned last week, Sabin Thivièrge, after three and a half years in this role, is moving

on to new challenges. If you are interested in the position, or know of someone who might be, check our website for more details!

Now to business. This week, a new contributor to Good Reads. Over to you, SHANNA!

During my pregnancy, Beatrice and I read a lot of books about the changes and what to expect when a new person is joining your family. The physiological changes sparked curiosity, and we addressed that as best we could, but the long-term change was a new addition to our family. In that area, two of the books which are best suited for very young children are *Waiting for Baby* and *My New Baby*, by Annie Kubler (Both available in the Lennoxville Library, [call numbers: PB K952mnb JUV-E C-30, PB K952wfb JUV-E C-30]). These are wordless picture books with very beautiful and thought-

ful illustrations that you and your child can explore and discuss. The illustrations of both books inspire conversation and normalize the lived experience of a small child who is waiting for, then experiencing a new baby. For older children, there is a lovely book called *A New Baby is Coming!* A Guide for Big Brother or Big Sister, by Emily Menendez-Aponte (M5424 Disco C-16). It has quite a lot of text, and it is organized into different topics and focuses on the emotions that a child might feel as his or her world is changing. One aspect of the Menendez book I really appreciated was that it is also adoption inclusive, because there are many ways to make a family.

Children are by nature curious. Discussing how creatures reproduce and welcoming the questions that arise from young children can help pave the way to a lifetime of healthy communication, and if you are feeling awkward about it, you child might notice and feel ashamed for asking. A good book can act as a buffer and hopefully open the doors to the delightful wonder of a child learning something new.

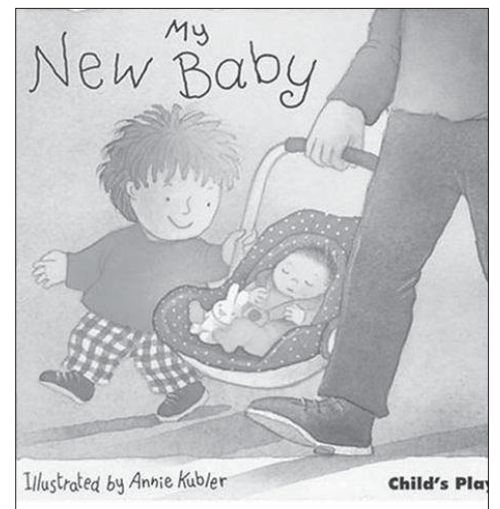

Follow The Sherbrooke Record on Facebook and Twitter!

[sherbrookerecord](https://www.facebook.com/sherbrookerecord) [@recordnewspaper](https://twitter.com/recordnewspaper)

## Ben by Daniel Shelton



# LOCAL NEWS

*“It’s unfortunate after a year of Liberal Government, with a cabinet minister at the table, that an issue like the Sherbrooke airport is not resolved yet,” Dusseault said*

## Pierre-Luc Dusseault: one year later

By Gordon Lambie

October 19, 2015 was a night of mixed emotions for Sherbrooke MNA Pierre-Luc Dusseault. While on the one hand he managed to hold onto his seat in the House of Commons for a second term in office, he proved to be one of the only sixteen MPs who did so in the province while 43 other ridings turned in other directions. One year out from that night, Dusseault shared similarly mixed feelings about the way that the Trudeau Liberals are now running the country.

“The quality of debate and climate in parliament is better than it was before under the Conservatives,” the Sherbrooke MNA said, explaining that he has seen a much greater openness to collaboration and working together on matters with the Liberals than there was under Stephen Harper’s government, “but it’s a government of consultation we’ve seen so far, other than a few symbolic decisions at the beginning.”

While being clear that he is not opposed to the idea of public consultation, Dusseault said that he and his party find it disappointing that the Liberals have turned solid campaign promises on matters like the future of Canada Post into opportunities for more discussion.

“It’s unfortunate because people elected this Liberal government because they wanted change, and they thought the Liberals would bring that change but we’re still waiting,” The MP said. “I’m not saying consultation is bad, but at some point decisions have to be made.”

While praising the Liberals for reinstating the long-form census and giving Canada’s scientific community back the right to speak for themselves, Dusseault was critical of the government’s take on climate change, which he described as “agreeing to targets without a concrete plan to achieve them.”

“We were expecting more,” the MP said, arguing that the Liberals, “signaled left during the election but turned right once they were in power.”

On the local level, Dusseault expressed deep disappointment regarding the lack of progress of the Sherbrooke Airport.

“It’s unfortunate after a year of Liberal Government, with a cabinet minister at the table, that an issue like the Sherbrooke airport is not resolved yet,” Dusseault said, explaining that a coalition of small airports across the country are currently locked in price negotiations with CATSA, the Canadian crown corporation responsible for airport security, to determine a reasonable cost for providing service.

“I would hope that the Federal Government will put more pressure on CATSA to resolve those negotiations, but it doesn’t look like it’s a priority for them to resolve this issue and see it move forward,” the NDP MP said “It is unfortunate for Sherbrooke and the region as a whole.”

Other than the situation with the airport, Dusseault said that he feels like things are going well for Sherbrooke.

“The situation is pretty good right now in Sherbrooke,” Dusseault said. “The local economy is showing good



GORDON LAMBIE

*Pierre-Luc Dusseault, while on the campaign trail last year.*

signs and good prospects for the future.”

Looking to his own party and its recovery after the losses sustained last year, Dusseault expressed no great enthusiasm about the NDP leadership race, but also suggested that the debate might provide the right climate for rebuilding the party into a stronger unit for the next election.

“It’s a work in progress,” the MP said, noting that the NDP built themselves up as an opposition to Stephen Harper’s Conservatives and suggesting that the party needs a different approach and outlook under a Liberal government. “I think that a leadership race is the perfect time

to reflect on our future and our core values.”

Among those core party values, Dusseault listed income equality for all Canadians, access to affordable and high quality universal healthcare, and justice for Canada’s indigenous peoples.

“It’s maybe not an issue very close to Sherbrooke itself, but on the national level it is a big issue,” the MP said. “It’s a matter of justice because indigenous people do not have access to the same level of healthcare and education as other Canadians.”

## Magog issues water notice for Sunday

Record Staff  
SHERBROOKE

The City of Magog has sent its residents a drinking water non-utilization notice for this Sunday, between 9 p.m. and midnight. The interruption of service is necessary so that the City can carry out the replacement of a water valve at the Des Pins reservoir.

This notice applies to all residences, businesses, and industries that are served by the Magog aqueduct network. After midnight, the water can be used and consumed normally.

The water will remain drinkable for the duration of the work, but it is possible that there will be a drop in pressure during this period. Therefore, residences and businesses whose facilities might be affected by a drop in pressure should take steps to address the problem.

It is also advisable to have bottled water handy. Laundry, bathing, showering, flushing the toilet, and using the dishwasher should be postponed to another time.

The City apologizes for any inconvenience this may cause and thanks the public for its cooperation. For questions, call 819 843-3333 during business hours: Monday to Thursday from 8 a.m. to 4:30 p.m. and Friday from 8 a.m. to noon.

For emergencies, call 9-1- and for any important information request outside business hours, contact the Memphremagog Police at 819 843-3334.

**THE HUT HALLOWEEN DANCE**  
featuring  
**NIGHT TRAIN**

**SATURDAY, OCTOBER 29**  
**AT 8 P.M.**

**Admission: \$5 if in costume**  
**\$8 if no costume**

A.N.A.F. Unit 318  
300 St. Francis St.  
Lennoxville  
819-346-9122

### APPOINTMENT



The **Caisse Desjardins des Deux-Rivières de Sherbrooke** is pleased to announce the nomination of **Ms. Ève Bazin**.

She has been Personal Finance Advisor for a couple of years. Ms. Bazin holds a Bachelor’s degree from Laval University.

She will be pleased to assist the Lennoxville population in their projects, either financing or saving.

**Desjardins**  
Caisse des Deux-Rivières de Sherbrooke

Lennoxville Service Centre  
174, rue Queen  
Sherbrooke, J1M 1J9  
819-565-9991  
desjardins.com

## School Page

## Bishop's College School

## Governor General's Bronze

BCS

A very special award was presented in Chapel this week. The Governor General's Academic Medals were created in 1873 by Lord Dufferin, Canada's third Governor General. Lord Dufferin wanted to encourage academic excellence across the new confederation. Since this time, the Governor General's Academic Medals have recognized the outstanding scholastic achievements of students in Canada, with the program evolving over the years. These medals are recognized as the most prestigious award a student in Canadian schools can receive.

Today, the Governor General's Academic Medals are awarded at four distinct levels: Bronze at the secondary school level; Collegiate Bronze at the post-secondary, diploma level; Silver at the undergraduate level; and Gold at the graduate level. Medals are presented on behalf of the Governor General by participating educational institutions, along with personalized certificates signed by the Governor General.

At the secondary school level in Quebec, the medal is awarded to the student who achieves the highest average of all grade 10 (Form V) and grade 11 (Form VI) courses.

Form VII student Julia Coote is this year's recipient and Mr. Lewis proudly presented her medal to her yesterday. Congratulations, Julia, on this phenomenal achievement!



PHOTO COURTESY OF BCS

## Quebec Liberals investigating sex assault allegation against one of their own

By Jocelyne Richer

THE CANADIAN PRESS

The governing Quebec Liberals scrambled to gather information Thursday after a young woman's allegation she was sexually assaulted by a caucus member.

Premier Philippe Couillard said he's taking the matter seriously and has asked the party whip to launch an immediate internal investigation to determine if the accusation is founded.

At a Universite Laval vigil Wednesday evening in support of victims of alleged sex crimes at a student residence, a woman said she was assaulted while working as a hostess at a Quebec City restaurant in the summer of 2014.

In a Facebook post that has since been

deleted, the woman wrote the alleged aggressor was a Liberal member of the legislature.

He was not named.

She wrote that the sitting politician allegedly blackmailed her to not pursue the complaint, but that she ended up filing one with police a year later.

The young woman said in the social media post the investigation went nowhere and she claimed she ultimately lost her job because the politician was an old friend of the restaurant owner.

She said she has been marked for life by the event — both physically and psychologically.

Parti Quebecois Leader Jean-Francois Lisee suspected a "cover-up" and called for two investigations — one by police on the assault allegation and another on any attempt to conceal the affair by an

independent organization that investigates police.

"There's a name out there," Lisee said about the identity of the politician at the centre of the allegation.

Quebec City police confirmed a complaint was filed and that an investigation is ongoing.

Couillard told reporters the matter will be treated with the highest priority.

"This is a very delicate question," he said. "I'm not the police, I'm not a judge, I'm not even a lawyer, but I just want to tell Quebecers that to me this is significant, not only significant, but crucially important for our society."

Rosalie Genest, a close friend of the complainant, told a local radio station the young woman sustained injuries stemming from the 2014 assault. It allegedly required hospitalization and

treatment, including stitches.

Nathalie Roy, a member of the Coalition for Quebec's Future, was in the crowd Wednesday night when the young woman spoke.

"My heart stopped when I heard her say this person sits in the national assembly," Roy said. "If a police officer tells you 'it's not worth it, he's stronger than you' — what she was saying yesterday, that's unacceptable."

Lise Theriault, the minister responsible for the status of women, said she was shocked by the woman's allegations and invited all female victims of assault to denounce them.

"No one is above the law," Theriault said, adding her caucus colleague would not have any favourable treatment should the allegations be confirmed.



- Soffit/Fascia
- Roofs
- Renovations

Mini-Excavation G-A-S  
Drain installation

- Doors/Windows
- Covering material
- Folding aluminum

Sidewalk manufacturing



FREE  
ESTIMATE

Compare and you'll see, competitors don't exist

Tel.: 819.566.5603 • Fax: 819.820.8890 • www.gouttieresaluminiumsherbrooke.com • 2305 St-François North, Sherbrooke



# Youth sentenced to community service for attempted rape

Record Staff  
SHERBROOKE

A Sherbrooke adolescent has been sentenced to perform 180 hours of community service after being convicted of attempted sexual assault.

The offender will also have to hand over a symbolic sum of \$500 to the victim. He will be on probation for two

years with follow-up.

He will have to continue his therapy for sex offenders,

His sentence also stipulates that he must avoid contact with the victim, not to be within 10 metres of the victim, her residence, or her school. He will also have to submit DNA samples.

On June 27, 2015 the boy snuck into

the victim's home wearing a mask and tied her wrists. He eventually left, but was arrested and charged.

He pleaded guilty to three charges including break and enter, forcible confinement, and wearing a disguise with intent to commit an indictable offense.

The Crown demanded a sentence with detention and Judge Lise Gagnon

acknowledged that the accused had committed extremely serious offenses and that no penalty would restore a sense of security to the victim. However, she added that the sentence should promote the rehabilitation of the young man and protect the public.

The youth repeatedly stated in court that he sincerely regretted his actions.

# Jacques-Cartier bike lane project extended until tonight

Record Staff  
SHERBROOKE

The City of Sherbrooke has extended its bike path pilot project on the Jacques Cartier Bridge until Friday evening. Motorists will therefore have just a single lane in each direction until

the end of the week.

"We changed the coordination of traffic lights and we have given two lanes of the bridge to motorists approaching the intersection of Jacques-Cartier Blvd South and Denault St.," said the Director of Urban Infrastructure Services, Caro-

line Gravel. These measures have greatly improved the flow of traffic on Jacques-Cartier South.

After making these adjustments, the City now wants to analyze traffic on Jacques-Cartier South for a few days in order to get a real picture of the situa-

tion. As the flow of traffic on Thursday and Friday is often different from the rest of the week, the City will extend the project until Friday evening.

Since last Thursday, the second south-bound lane on the bridge has been reserved for cyclists.

# Suspect nabbed in Overflow thefts

Record Staff  
SHERBROOKE

Sherbrooke Police arrested a man Thursday morning in connection with two robberies last summer at the Overflow restaurant on King St. West

in Sherbrooke. The individual was nabbed at his home on Vimy St.

In addition to the arrest, police seized several items as part of the investigation.

The suspect allegedly broke into the restaurant in June and again in August,

stealing cash the first time and bottles of liquor the second.

"The arrest was made possible thanks to information received from the public that allowed the suspect to be traced.

The suspect has been questioned by

investigators from the Sherbrooke Police and criminal charges could be brought against him.

# Robert steps down

CONT'D FROM PAGE 1

that will reach unprecedented volumes of diverted materials, and transitional funding from the City-school program, among recent achievements.

Several files are also ongoing, such as regulations to guide the development of wind farms and the expansion of Graymont, increased residential opportunities in a green zone, with respect for agriculture and diversification of activities at Station 112. Other files under the responsibility of the MRC have been very successful during Robert's tenure including the modernization of assessment rolls, the development of an inter-municipal fiber optics network, access to geospatial data, an update of the waste management plan, and the development of a fire and emergency services.

For all these reasons, the Haut-Saint-François is acknowledging Robert's invaluable contribution to local life.



COURTESY

Haut-Saint-François MRC Prefect Nicole Robert steps down due to health reasons

## OPEN HOUSE

2016-2017



Leave your mark



Meet members of faculty and staff

Saturday, October 29, 2016  
10:00 a.m. - 2:00 p.m.

Tour the campus

Visit residence

Champlain  
COLLEGE - LENNOXVILLE

www.crc-lennox.qc.ca  
2580, rue College, Sherbrooke (Québec)  
819 564-3666



LIGNE POUMON-9

1 888 POUMON-9



To help you quit smoking

# EDITORIAL

Ah, the sixties. Remember it. The Disorder Decade. Violence, protests, turmoil, Vietnam, burning cities, occupations, marches, Black Panthers, anger.

## The Last Reunion



**TOM CAVANAGH**

A few months ago I received a conference call from three old friends and former teaching colleagues in British Columbia. We had been out of touch for years and what a pleasant surprise to hear from them again. They were calling to invite me to join them for the fifty-year reunion at Selkirk College in Castlegar, B.C. where we had taught together some fifty years ago. Yeah, in the sixties. An incredible unexpected call and how wonderful and sweet. I was there only one year (1968-69) but what a marvelous one that was. As the fates would have it our youngest son living in Vancouver today was urging us to visit him. Why not? Two birds with one stone. The stars were all aligned and Castlegar and Vancouver are not far apart. Let's go!

At Selkirk the celebrations were pleasant, fairly casual and informal especially for our group of about thirty who were all together away back in the sixties when Selkirk came to be. We were a bit apart as a group with a wee hint of prestige. I think. Maybe not. Certainly a long ways from the honours bestowed on Napoleon's Old Guard.

For Rosemary and I the few days at Selkirk were memorable. We revisited the home and park nearby where we had played ball, rambled about, skied, and hiked depending on the weather. What a wonderful time with the mountains so close you could touch them.

There was ample time and occasions for talks and speeches. Organizers provided opportunities for individuals to reflect, joke, and reminisce. Dangerous I was thinking since some may love the sound of their own voice and go on and on. Not so at Selkirk College. Our colleagues were memorable, moving, disciplined, and truly fascinating. The

organizers also provided suggestions to encourage our involvement: E. g, What led you to Selkirk? Why did you leave? What did you like most? Any regrets? Etc.,

I offered a few short words about how we loved our short time in Castlegar and the friends and good times we experienced there in the sixties. I had the good luck of connecting with the Doukhobours as friends, but those are tales for another day.

Question? If it was so sensational and satisfying why did we ever leave? Well there is an answer. (Indeed several.) My life long dream was to live in Africa and almost without warning I received an offer from CIDA to teach in Ghana. My dream. My wife's nightmare. There were good reasons for not accepting. Four children with the oldest six. My wife's mother was sure we would lose at least some of them if we went. One can joke about it now. Not then. I explained that Africa has no great demand for Canadian historians, and if we said no there might never be another chance. And so we talked debated and walked and talked some more. Stress in marriage like we had never known. We had it big time. Finally, we decided to accept. Our reasons for leaving Selkirk were complex. Sometimes there are no winners or losers. I will leave it at that. Except to say that I have lived and taught at many levels and places in different countries and provinces, and none were more stimulating and than Selkirk College. Teaching is a great profession and never more gratifying than our time at Selkirk.

Ah, the sixties. Remember it. The Disorder Decade. Violence, protests, turmoil, Vietnam, burning cities, occupations, marches, Black Panthers, anger. Selkirk was no exception to the times, and as a teacher of American history I was a bit of a target. Students visited from UBC and Simon Fraser bringing views of American history as sort of a horror story. They certainly were not shy about adding something to the class. America the source of all evil. Well, I can overreact too but what a fortunate place to find myself. What a wonderful setting for someone who loves history. There were conflicting views certainly, but I must not exaggerate. The



visitors were not often there. So be it. And they had something to add. And we were happy.

The students were often angry over issues in the news, and rightfully so. Some will remember the Kent State murders. Even fewer still will recall the Mexican students experiencing similar treatment in Mexico city. We talked, argued, lamented and sang.

"HOW MANY TIMES CAN A MAN TURN HIS HEAD AND PRETEND THAT HE JUST DOESN'T SEE / THE ANSWER MY FRIEND IS BLOWING IN THE WIN", THE ANSWER IS BLOWING IN THE WIND." Thank you Dylan. I knew all the words and walked alongside the students, their council, and those with the guitars – and faculty. I may be overreacting but by God it was a wonderful time with memories to treasure and cherish. There are other things too. The Vietnam war. There were many things to pull you down but I suppose it is simply part of the human condition to forget a lot. On occasion the college was closed for full days with no classes offered so we could investigate, rant and learn more about our own problems and the world. For example, the Mounties did raid UBC. Why? Should we not be doing something? Why are we having study days? Educa-

tion? What for? A great time for teaching. I reckon we could and should have done more but the memories remain powerful. I found this old quote in my yellowed files.: "Parallels exist between the treatment of Negroes and women in our society." (Sound familiar? It should. 1965. More needs doing.)

So why did we leave Selkirk? Simple answer but a tough decision and a long time in doubt. We received a telegram from CIDA offering us a job teaching in Ghana. My dream come true. For my wife Rosemary it was a nightmare. Four young children under seven. Thanks but no thanks. Rosemary made a strong case for saying no. Talk about stress in marriages. On the other hand there is little demand for Canadian historians in Africa. This may be our/my one and only chance. The discussions went on and on. Her position was strong and it was up to her. We were in a wonderful setting, and Rosemary's mother and others warned that we might lose one or more of our beloved children. Not something we could ignore. Somehow, based on unclear reasons for me Rosemary gave me my wish. End of story. We feel now it was the right decision. Luck too was a factor.

## Letters

The Record welcomes your letters to the editor. Please limit your letters to 300 words. We reserve the right to edit for length, clarity, legality and taste. Please ensure there is a phone number or email where you can be reached, to confirm authorship and current town/city of residence. Names will not be withheld but the address and phone number of the writer are not published, except by request. Please email your letters to newsroom@sherbrookerecord.com. Preference is given to writers from the Eastern Townships.

## THE RECORD

1195 Galt East, Sherbrooke, Quebec J1G 1Y7  
 FAX: 819-821-3179

E-MAIL: newsroom@sherbrookerecord.com  
 WEBSITE: www.sherbrookerecord.com

SHARON McCULLY PUBLISHER ..... (819) 569-9511  
 STEPHEN BLAKE CORRESP. EDITOR ..... (819) 569-6345  
 SERGE GAGNON CHIEF PRESSMAN ..... (819) 569-9931

DEPARTMENTS  
 ACCOUNTING ..... (819) 569-9511  
 ADVERTISING ..... (819) 569-9525  
 CIRCULATION ..... (819) 569-9528  
 NEWSROOM ..... (819) 569-6345

KNOWLTON OFFICE  
 5B VICTORIA STREET, KNOWLTON, QUEBEC, J0E 1V0  
 TEL: (450) 242-1188 FAX: (450) 243-5155

### PRINT SUBSCRIPTIONS

		GST	PST	TOTAL	
QUEBEC:	1 YEAR	135.60	6.78	13.53	\$155.91
	6 MONTHS	71.19	3.56	7.10	\$81.85
	3 MONTHS	36.16	1.81	3.60	\$41.57

### ON-LINE SUBSCRIPTIONS

QUEBEC:	1 YEAR	71.50	3.58	7.13	\$82.21
	1 MONTH	6.49	0.32	0.65	\$7.46

Rates for out of Quebec and for other services available on request.

The Record is published daily Monday to Friday. Back copies of The Record are available.

The Record was founded on February 9, 1897, and acquired the Sherbrooke Examiner (est. 1879) in 1905 and the Sherbrooke Gazette (est. 1837) in 1908. The Record is published by Alta Newspaper Group Limited Partnership.

PM#0040007682

Return undeliverable Canadian addresses to The Record, 1195 Galt East, Sherbrooke, QC J1G 1Y7

Member

ABC, CARD, CNA, QCNA

# COLUMNIST

*Dignity is not something we confer onto others or even give ourselves, but we must claim it.*

ONE COLUMN, FOUR VOICES

## Opening to the Spirit

Today's word: Dignity

By Revs Mead Baldwin,  
W. Lynn Dillabough,  
Lee Ann Hogle, and  
Carole Martignacco

1 ) Steve was a keener at church. He was active in youth group, liked to read scripture, and acted in some of my church plays. He had some social anxiety and sometimes felt insecure. His younger brother was tall, athletic, and great at school while he struggled sometimes. Steve's life was not easy and became even more difficult when he was diagnosed with brain cancer. After months of tests and treatment he received the news that it was terminal. There were long talks, prayers, and anguish but he somehow discovered dignity and strength.

He was moved home from the hospital, a beautiful house in the country. His parents organized caregivers, and friends and neighbours pitched in. He was well medicated to deal with the pain. One night I dropped over after supper. He sat in his wheelchair on the porch and we watched the beautiful sunset. I had a sense that something was different so I called home to say I would stay the night. Around 2 a.m. we held hands around the bed and said prayers. Within an hour Steve died peacefully, surrounded by love. His loved the Prayer of St Francis, part of which reads:

"Grant that I may not so much seek, to be consoled as to console, To be understood as to understand, to be loved as to love with all my heart..."

When I heard the word today's word I immediately thought of Steve, and countless others who have chosen to die with dignity. I am glad to be in a country where we are given that freedom.

~~~

2 ) In the course of my daily activities I often meet people who are facing diminishing physical capacities and I am always struck by the dignity with which each new incapacity is encountered. Mastering the ability to accept declining health with grace and dignity; isn't that one of the greatest challenges of living to a ripe old age?

The underlying message it leaves me with is "Life is worth living. Despite the hardships, the sorrows, the losses, life is eminently worth living." Every time I see an older person laughing, struggling to get out of their chair, or making their peace with being wheelchair bound, I hear this underlying message. There is so much to life that is really good, that

all the health problems diminish in importance.

The dignity I see in the face of those who are aging encourages me whenever I am discouraged and feel like giving up. Life is so much more than the worst thing that ever happened to me, and I hope that I too am learning to age with dignity.

~~~

3 ) One of the vows of the Anglican baptismal covenant asks: "Will you strive for justice and peace among all people, and respect the dignity of every human being?" The answer to this is: "I will, with God's help."

What does it mean to have our dignity respected? An absence of mocking or ridicule, and an absence of belittling, for sure, but what else would we notice? We would be seen and accepted for who we are. Our differences would be valued and welcomed. No one would need to be on the defensive, because we would all know that we are valued.

Much of dignity, I think, is internal. I can walk in dignity and respect my own dignity regardless of how others are treating me. Think Nelson Mandela. Think Malala Yousafzai. Think about anyone immune to bullying.

Sometimes, people don't know their own dignity. Sometimes, they have been so put down that they walk with shoulders slumped, expecting very little.

In our baptismal vow, we promise to respect everyone's dignity, whether they can recognize it themselves yet or not. May our actions help others to know their dignity. May we all know our own dignity. And may justice and peace come among us.

~~~

4 ) Dignity - that essential human quality that transcends circumstances or fortune. Romanian-born Jewish writer Elie Wiesel in his stories about the concentration camps documents memorably the incredible dignity of those amidst unspeakable suffering, who to their dying breath treated fellow inmates with simple kindness, compassion and love.

Dignity goes beyond social or economic class or any other arbitrary measure of status or worth. My English grandmother used to say, "When all else is lost, you can still hold onto your dignity." Born into wealth, she'd married into poverty and was equally gracious in any situation. As a child I observed on

Sunday visits how she could transform even the simplest supper into a banquet. From one end of the table she presided over meals prepared and served from her humble kitchen like a queen - and I knew myself blessed to be among her subjects.

Dignity is not something we confer onto others or even give ourselves, but we must claim it. Inherent means it arises from our very being, and can only be surrendered from within. By our common origins in the Source of All That Is, we are made in the image and likeness of Infinite Goodness. To lose one's dignity or deny it to others is a refusal of our birthright. So in my religious tradition, the first guiding principle we agreed upon is to "affirm and promote the inherent worth and dignity of every person."

In this election season, what horrifies so many is an unprecedented lack of dignity. In the face of so much that is offensive, we can choose to maintain an

awareness of our own best humanity and restore it to all levels of discourse. Why not answer with a revival of dignified civility!

~~~

**One word, four voices - now add yours: What does it mean to live a life with dignity?**

~~~

*Rev. Mead Baldwin pastors the Hatley, Waterville & North Hatley United Churches; Rev. Lynn Dillabough is now Rector of St. Paul's in Brockville ON. She continues to write for this column as a dedicated colleague with the Eastern Townships clergy writing team; Rev. Lee Ann Hogle ministers to the Ayer's Cliff, Magog & Georgeville United Churches; Rev. Carole Martignacco pastors UUEstrie - the Unitarian Universalists in North Hatley.*

The Bishop's University Drama Department presents

# Coma Unplugged

by Pierre-Michel Tremblay  
English translation by Micheline Chevrier

October 26-30  
Turner Studio Theatre  
Bishop's University

Directed by  
George Rideout

Wed. October 26 • Original French text  
Thurs. October 27 • English translation  
Fri. October 28 • Original French text  
Sat. October 29 • Original French text  
Sun. October 30 • English translation

Tickets: \$15/adults • \$12/Seniors • \$8/Students  
Box office: 819-822-9692

UNIVERSITÉ BISHOP'S UNIVERSITY

All shows begin at 8PM

Follow The Sherbrooke Record on Facebook and Twitter!

 sherbrookerecord 
  @recordnewspaper

# Local Sports

Ballou had five goals and five assists in 21 games this season with the Impact's USL team, Montreal FC.

## Quebec minor hockey coach to sit out season for ordering push ups after loss

The Canadian Press

abella after learning he ordered his 11- and 12 year-old peeewe AAA players to do push-ups following a 7-2 loss on Sept. 18.

"The committee said it was not the right thing to do, and it was a punishment, and that's why they decided to suspend Mr. Isabella," Fortier said.

The suspension is in place until May 2017.

Although media reports said the children were assigned hundreds of push-ups, Fortier said he was told the number was between 50 and 100.

He said the organization learned about the allegations through a report in Montreal La Presse.

Isabella had been previously removed from his functions until the committee could hold a disciplinary hearing.

Fortier said the organization isn't necessarily against push-ups but it believes they shouldn't be inflicted as a penalty.

"It's appropriate as part of a training session, not as a punishment after a win or a loss," he said.

The Lac St-Louis Lions are currently looking for another coach for the rest of the season.

A Montreal-area minor league hockey coach who ordered his team to do push-ups after a loss will sit out the rest of the season, the hockey association's president said Thursday.

Jean-Pierre Fortier said the disciplinary committee of Hockey Lac St-Louis recently decided to suspend Louis Is-

## Impact sign promising 17 year old forward Ballou to two year contract

The Canadian Press

the 2017 season, the Major League Soccer club announced Thursday.

The Ivory Coast-born Canadian is the youngest player ever signed to the Impact's MLS squad. He will also take part

in a 10-day camp with Bologna FC in November.

Ballou had five goals and five assists in 21 games this season with the Impact's USL team, Montreal FC.

"He is an exciting attacking player who has strong technical abilities and is able to be creative and dynamic in the final third," technical director Adam Braz said in a statement. "We look for-

ward to seeing him evolve and progress with the first team."

The five-foot-nine winger was named the Canadian under-17 Player of the Year in 2014 and the Quebec Soccer Federation male youth player of excellence in 2014 and 2015. He has scored three goals in 14 games with the Canadian under-17 and under-20 squads.

The Montreal Impact signed 17-year-old forward Ballou Jean-Yves Tabla to a two-year contract beginning in

**Featuring performances by:**

**A Paul Simon Tribute Concert**

a MUSÉCOLE PRODUCTION to support music programs in schools

Back to De retour à Graveland

**Special Guests:**

Tim Brink Kate Morrison Jon McAulay Jamie Crooks Matthew McCully

**Saturday, October 29, 2016 8pm**  
at Centennial Theatre

**TICKETS: \$20 Regular \$15 Students & 65+**

RESERVATIONS: The Record (819)569-9525 classad@sherbrookerecord.com

# SHARE THE WARMTH

Kids love to play in the snow.  
Let's make sure they can.

**INFORMATION & DONATIONS**  
(819) 564-6626 INFO@LDWC.CA

PLEASE SEND CHEQUES TO  
The Lennoxville & District Women's Centre  
300-257 Queen Street, Sherbrooke QC J1M 1K7  
(Charitable receipts can be issued for donations of \$10 or more)

We will also accept new and gently used snowsuits, boots, thermal hats, mitts & scarves (for children of all sizes - tiny to teen)

Lennoxville & District Women's Centre  
300-257 QUEEN ST. SHERBROOKE J1M 1K7  
(819) 564-6626 INFO@LDWC.CA

EMPOWERING & CONNECTION  
English Speaking Women & their Families in the Estrie Region through  
EDUCATION, SUPPORT & ADVOCACY

THE RECORD  
THE VOICE OF THE EASTERN TOWNSHIPS SINCE 1897

# Local Sports

Today the 47-year-old Squamish, B.C. resident owns and operates Uprise, a training facility where he is also the strength and conditioning coach.

## Elite ultra runner Paul Romero credits Regenurex for extended career



A RUNNER'S MIND

CHRISTINE BLANCHETTE

"Go fast, take chances"  
- Paul Romero - Elite Ultra Runner and Coach

Paul Romero has achieved the proverbial impossible when pushing the limits of his athletic abilities. For Romero, the mental toughness and physical stamina comes naturally, or in other words, pushing the limits is in his DNA. While growing up in Southern California, Romero, who credits his father Alex for introducing him to sports, excelled at everything from football to basketball to becoming a biking champion, which led to coaching himself to race. He discovered ultra running in 2013 when he helped create the Kodiak Ultra Marathon 100-mile race in the San Bernardino Mountains, placing 7th overall. Soon afterwards he moved to Canada for an opportunity to run performance camps and continue ultra racing.

Today the 47-year-old Squamish, B.C. resident owns and operates Uprise, a training facility where he is also the strength and conditioning coach. Romero shares his time between B.C. and Maui, coaching and mentoring his athletes.

In May, 2010 Romero and his partner Karen, along with his 13-year-old son Jordan climbed Mt. Everest and amazingly reached the summit to become the first family to conquer the highest peak in the world. Romero is a member of the elite 7 Summits Club, which means he has climbed the highest mountain on every continent.

In a phone interview he talked about his ultra marathon training, recovery, and his testimonial to Astaxanthin, which is an anti-inflammatory and antioxidant developed by Regenurex Health Corp.

Romero says, "Working out is in my veins and I enjoy very challenging and unconventional training routes." The

world traveler has made the podium in over 100 expedition adventure races on 5 continents over the last 13 years. "My team will be leaving for Malaysia tomorrow to compete in team adventure racing," Romero said, adding, "I'm looking forward to coaching and racing, and it has been two to three years (between adventure races). I am ready."

Here are his tips - 4 Reasons Why Strength Training is Vital for Running

1. Body Composition- Moving heavy things creates a metabolic change in us. There are positive metabolic and hormonal changes shifts that happen, rapidly and properly. This may look like leaning, muscle gain, which both lead to improved health and efficiency.

2. Injury Prevention- Life in 2016 is about going 12 months a year, strong. Strength training has been proven to reduce injuries significantly. This works well for our athletes.

3. Power- Wiki says: to move or travel with great speed or force. Do strength training and your body will move, with power and grace.

4. Speed- a product of endurance and power. Enough said.

On Astaxanthin, which is approved by Health Canada, Romero uses it daily and credits it for both his improved recovery time and better vision. He says, "I have been taking Regenurex for a while now and I don't feel the wear and tear I did before when I was taking other brands. I feel my recovery and training has become stronger. There have been over 200 successful clinical studies done all over the world. The product helps with recovery, joint pain and eye health." When asked how his vision was affected by the product, he said, "I noticed my eye sight improved in two to four weeks. I was at a board meeting and I could read my cell phone again. My vision was clearer."

When Romero climbed Mt. Everest, he claims the product helped him both as anti-inflammatory and with recovery. Last month he placed third in the Tahoe 200 ultra marathon, a race which took 62 hours to complete. Romero notes in Lake Tahoe, he only used Astaxanthin as his anti-inflammatory and he managed to run the race without pain and so did not need to take any painkillers. It also helped significantly with his post-race recovery

David Turner, CEO of Regenurex Health, based in British Columbia, Canada

claims that Regenurex is the strongest antioxidant produced by na-

ture and is a strong natural anti-inflammatory. It's more than 6,000 times stronger than Vitamin C and more than 40 times stronger than beta carotene. It is unique in that it targets the mitochondria which are the powerhouse of our cells.

Astaxanthin helps to reduce inflammation and so helps alleviate pain from arthritis, joint, muscle and tendon pain as well as being an excellent product for runners to help with recovery and as a

source of energy.

When it comes to healthy eating, Romero enjoys chia, coconut milk, eggs, avocados, and ginger. Romero has a passion for leading a healthy lifestyle and sets no limits on what he can do as an athlete and inspiring his son Jordan and his team to do the same.

www.runwithit.ca  
Twitter: @christineruns  
YouTube - runwithitcb1



GET YOUR TICKETS NOW

OCT. 21st AT 7 P.M



VS



OCT. 22nd AT 4 P.M

VS



hockeyphoenix.ca - 819-560-8842

#PHOENIXSHERBROOKE

I'm gonna be a Fireman someday.

Muscular Dystrophy Association of Canada

1 800 567-ACDM  
Until there's a cure, there's us.

# Church Services

## Anglican

### FOSTER

James Anglican Church, Foster. We open our doors to welcome you on Sunday, October 23 at 9:15 a.m. for a Service of Morning Prayer, at the little church on the hill, 725 Lakeside, Foster. Please join us afterwards to visit over refreshments. Everyone is welcome.

### LENNOXVILLE

Saint George's Anglican Church, Lennoxville, at 84 Queen St., celebrates Holy Eucharist every 1st & 3rd Sunday at 11 a.m. Morning Prayer is held every 2nd & 4th Sunday at 11 a.m. Sunday School every 1st & 3rd Sunday at 11 a.m. 819-346-5564.

### SHERBROOKE

October 23, Church of the Advent, 473 Bowen St. S., Sherbrooke invites you to a service of Holy Communion with the Ven. Dean E. Ross officiating.

## Presbyterian

### LENNOXVILLE

St. Andrew's Presbyterian Church, 256 Queen St., Lennoxville, 819-569-3100. Sundays: 10:30 a.m. Worship and Sunday School. The Word of Grace Radio Broadcast, P.O. Box 404, Sherbrooke, QC, J1M 1Z6, Station CJMQ 88.9 FM or www.cjmq.fm, Sundays 8:30 a.m.

## United

### AYER'S CLIFF - MAGOG

Ayer's Cliff - Magog - Georgeville Pastoral Charge welcomes everyone for Sunday service at Beulah United Church in Ayer's Cliff - Worship service and Sunday School 9:15 a.m. and St. Paul's United Church, Magog - Worship Service and Sunday School 11:15 a.m. with lunch provided each Sunday following the service in Magog. Minister: Rev. Lee Ann Hogle 819-571-7233.

### HATLEY/WATERVILLE

Sunday, October 23, 9:30 a.m. St. Francis Manor, Lennoxville and 11 a.m. Waterville/North Hatley United with Sunday School. Rev. Mead Baldwin 819-837-1112.

### LENNOXVILLE

Lennoxville United Church, corner of Queen and Church Street, welcomes you to worship with Rev. Linda Buchanan on Sunday, October 23 at 10:00 a.m. Coffee and refreshments will be served after worship. Sunday school will be available on the first Sunday of every month. Children are always welcome. 819-565-8449; website- lennoxvilleunitedchurch.com

### SHERBROOKE

Plymouth-Trinity United Church, corner of Dufferin and Terrill, 819-346-6373, the Rev. Samuel V. Dansokho, minister, Leslie Young, organist. Sunday, October 23, English worship is at 10:30 a.m. We will be presenting the Bilingual Children's ministry during the service, a fun and educational programme for children aged 3-12. All are welcome! Le service en français se tiendra à 9 h dans la chapelle. Bienvenue à toutes et à tous!

### TRENHOLM

Trenholm United Church. Worship and song await you at our October Harvest Service which will take place on Sunday, October 23 at 11:00 a.m. Our usual "cookie hour" will follow. Everyone is welcome to join us.

# DO JUST ONE THING



By Danny Seo

If you want to naturally detox your shoes from the inside out, look no further than a sheet of newspaper. Newspaper is designed to absorb ink, so it also absorbs other things, like excess moisture and toxins. Stuff newspaper inside your shoes, then rest your shoes on top of more newsprint: All the chemicals, fertilizer, dirt, bacteria and lead your shoes pick up will be absorbed into the newspaper.

~ ~ ~

Whether you're using ground turmeric, dried rosemary or fennel seeds, all the seasonings in your spice rack should be organic. Conventional dried herbs and spices are grown with chemical fertilizers and pesticides. Worse, they are often irradiated to kill bacteria. Organic herbs and spices, on the other hand, are cultivated without chemicals and pests, and germs are eradicated through steam heat or a deep freeze.

## In Memoriam

## In Memoriam



**DAIGNAULT, Jennifer** - In cherished and loving memory of our dear daughter and sister who passed away twenty years ago on October 22, 1996.

Please don't mourn for me; I'm still here, though you don't see.  
 I'm right by your side each night and day and within your heart I long to stay.  
 My body is gone but I'm always near, I'm everything you feel, see or hear.  
 My spirit is free, but I'll never depart as long as you keep me alive in your heart.  
 I'll never wander out of your sight - I'm the brightest star on a summer night.  
 I'll never be beyond your reach - I'm the warm moist sand when you're at the beach.  
 I'm the colorful leaves when fall comes around, and the pure white snow that blankets the ground.  
 I'm the beautiful flowers of which you're so fond - the clear cool water in a quiet pond.  
 I'm the first bright blossom you'll see in the spring; the first warm raindrop that April will bring.  
 I'm the first ray of light when the sun starts to shine, and you'll see that the face in the moon is mine.  
 When you start thinking there's no one to love you, you can talk to me through the Lord above you.  
 I'll whisper my answer through the leaves on the trees, and you'll feel my presence in the soft summer breeze.  
 I'm the hot salty tears that flow when you weep, and the beautiful dreams that come while you sleep.  
 I'm the smile you see on a baby's face. Just look for me, I'm every place !

Always remembered and loved,

MOMMY, TIM, JANET, DEBBIE & SCOTT AND THEIR FAMILIES

**DAIGNAULT, Jennifer (1977-1996).** In loving memory of my daughter, Jennifer.

Three little words, "Forget Me Not,"  
 Don't seem like much, but mean a lot.  
 Just a memory fond and true,  
 To show, little girl, I still think of you!

Luv ya Munchkin.  
 DADDY  
 xxx

# SUDOKU

Difficulty: 5 (of 5)

|   |   |   |   |   |   |   |  |   |
|---|---|---|---|---|---|---|--|---|
|   |   |   |   |   |   |   |  |   |
|   | 4 |   |   | 8 | 7 |   |  | 5 |
|   |   |   | 3 |   |   |   |  | 1 |
| 2 |   |   |   |   |   | 4 |  |   |
|   |   | 1 | 7 |   |   |   |  |   |
| 9 |   |   | 5 | 2 | 3 |   |  |   |
|   |   | 3 |   |   |   |   |  |   |
|   |   |   |   | 2 | 3 |   |  |   |
| 5 |   |   |   | 8 | 2 | 9 |  |   |
|   |   |   | 3 |   |   |   |  | 6 |
|   |   |   |   |   |   |   |  |   |

10-21-16

©2016 JFS/KF Dist. by Universal Uclick for UFS

## PREVIOUS SOLUTION

|   |   |   |   |   |   |   |   |   |
|---|---|---|---|---|---|---|---|---|
| 4 | 7 | 3 | 6 | 8 | 2 | 9 | 1 | 5 |
| 5 | 6 | 2 | 4 | 1 | 9 | 8 | 7 | 3 |
| 8 | 9 | 1 | 5 | 7 | 3 | 4 | 2 | 6 |
| 2 | 5 | 9 | 7 | 3 | 8 | 1 | 6 | 4 |
| 3 | 4 | 8 | 1 | 9 | 6 | 2 | 5 | 7 |
| 6 | 1 | 7 | 2 | 4 | 5 | 3 | 9 | 8 |
| 1 | 2 | 5 | 8 | 6 | 4 | 7 | 3 | 9 |
| 7 | 3 | 4 | 9 | 5 | 1 | 6 | 8 | 2 |
| 9 | 8 | 6 | 3 | 2 | 7 | 5 | 4 | 1 |

**HOW TO PLAY:**  
 Each row, column and set of 3-by-3 boxes must contain the numbers 1 through 9 without repetition.

**Death**

**Roma F. BOYD (née Bobo)  
August 25, 1916 - October 17, 2016**

Passed peacefully on October 17, 2016 at Manoir Lac Brome in Knowlton in her 101st year after a short illness.

She was predeceased by her husband Ira, brother Lawrence (Bud), sister Edith and son Larry and was the daughter of Amos and Lena (Lamb) Bobo of Waterloo.

She is survived and will be dearly missed by sons Douglas (Susan) of Lewiston ME, Lorne of Pointe Claire, daughter-in-law Yolande Turcotte of Châteauguay, as well as grandchildren Matthew, Jessica, and Shawn (Natalie) and great-grandchildren Naomi, Harrison, and Ryan, as well as cherished nephew Jeff Lucia (Judith) and niece Susan Boyd (Claire) and other nieces and nephews and many close friends.

A visitation will be held on Sunday, October 30th, 2016 at Les Résidences Funéraires Bessette of Waterloo from 2:00 pm to 4:00 pm. A private family interment will follow.

Memorial donations may be made to the Brome-Missiquoi-Perkins Hospital Foundation or The Nature Conservancy of Canada, as Roma was a life long lover of the outdoors, nature, and especially birds.

Les Résidences Funéraires Bessette  
5034 Foster St., Waterloo QC  
Member of the C.T.Q.

PHONE: 450-539-1606  
FAX: 450-539-3035  
www.famillebessette.com

**Death**

**Death**

**Death**

**Muriel (Nugent) Winslow**



Muriel passed away peacefully at La Maison Aube-Lumière, Sherbrooke on Sunday, October 16, 2016 in her 97th year. Beloved mother to Marilyn (Doug), Helen (John) and Terry and stepmother to the late Rupert (Patty) (deceased) and Ross. Cherished grandmother to Steven, Jodi and Brian, four step-grandchildren: Peter, Timmy, Tammy and Tara and one great grandson Eric. Loved by her brothers: Harris (Gerry and the late Gloria) and Bobby (Truth). Predeceased by her brother Hubert (Marion) and her sister Doris (George). Also leaving to mourn many nieces, nephews, cousins and dear friends.

Visitation will take place at the Cass Funeral Home, 3006 College St., Sherbrooke (Lennoxville), on Saturday, October 22, 2016 from 1:30 p.m. to 3:00 p.m. followed by a celebration of life at 3:00 p.m.

Many thanks to the doctors, nurses, and volunteer staff at La Maison Aube-Lumière for the care and love they have shown Mom during her three month stay. Special thanks to her doctors Chantal Doyon and Marie-Jose Dubois for their amazing care. Mom loved you both very much.

We, her family would like to extend our appreciation to Cheryl Graham and Marjorie Robinson for your loving support.

The family suggests donations to La Maison Aube-Lumière, 3071, 12th Avenue North, Sherbrooke, QC J1H 5H3 or Maple Leaf Cemetery, c/o Linda Fisk, 67 Robert Peel, Sherbrooke, QC J1M 1X5.

CASS FUNERAL HOMES  
3006 College St., Sherbrooke QC  
E-mail: cass@casshomes.ca

PHONE: 819-564-1750  
FAX: 819-564-4423  
www.casshomes.ca

**Datebook**

FRIDAY, OCTOBER 21, 2016

Today is the 295th day of 2016 and the 30th day of autumn.

**TODAY'S HISTORY:** In 1879, Thomas Edison successfully tested an electric light-bulb.

In 1892, the original "Pledge of Allegiance" was recited by an estimated 12 million schoolchildren across the United States in honor of the 400th anniversary of Columbus' voyage to the New World.

In 1959, the Guggenheim Museum opened in New York City.

In 1967, more than 35,000 anti-war protesters stormed the Pentagon, resulting in nearly 700 arrests.

**TODAY'S BIRTHDAYS:** Samuel Taylor Coleridge (1772-1834), poet/essayist; Alfred Nobel (1833-1896), inventor/arms manufacturer; Dizzy Gillespie (1917-1993), jazz musician; Celia Cruz (1925-2003), singer; Whitey Ford (1928- ), baseball player; Ursula K. Le Guin (1929- ), author; Judy Sheindlin (1942- ), judge/TV personality; Benjamin Netanyahu (1949- ), Israeli politician; Carrie Fisher (1956- ), actress/writer; Ken Watanabe (1959- ), actor.

**TODAY'S FACT:** Of the seven fundamental units of measure in the International System, only the kilogram is defined by a specific physical object. It is the mass of a platinum-iridium cylinder kept by

**In Memoriam**

**MASTINE** - In loving memory of Everett John Mastine, November 15, 1935 - October 22, 2006.

*You gave me many things in life,  
Gifts both great and small,  
But most of all you gave me love,  
The greatest gift of all.  
Remembering you is easy,  
I do it every day,  
It's just the pain of losing you,  
That never goes away.*

**Thinking of you and love you always,  
NATALIE**

the International Bureau of Weights and Measures in France.

**TODAY'S SPORTS:** In 1975, Red Sox catcher Carlton Fisk hit a home run that glanced off the foul pole at Fenway Park in Boston, giving the Red Sox a 12th-inning victory over the Cincinnati Reds in Game 6 of the World Series.

**TODAY'S QUOTE:** "I wish our clever young poets would remember my homely definitions of prose and poetry; that is, prose = words in their best order; poetry = the best words in their best order." — Samuel Taylor Coleridge

**TODAY'S NUMBER:** 13.5 — hours Thomas Edison's first prototype electric incandescent lightbulb lasted before burning out.

**TODAY'S MOON:** Between full moon (Oct. 15) and last quarter moon (Oct. 22)

**Death**

**Death**

**Ronald POPE**

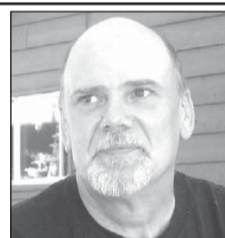

Ronald Pope passed away peacefully at his home on October 13, 2016. Son of Doris

Maskell and the late Lionel Pope. He leaves to mourn his daughter Taunya (Joey), his son Josh (Karen), his grandsons Treydenn and Hunter, his sisters Gail, Nancy and Cindy, and his brother Almon.

A private family burial will be held at the Cookshire Protestant Cemetery at a later date.

CASS FUNERAL HOMES  
3006 College St., Sherbrooke QC  
PHONE: 819-564-1750  
FAX: 819-564-4423  
cass@casshomes.ca  
www.casshomes.ca

**In Memoriam**

**MASTINE**, Everett John - In loving memory of Everett John Mastine, November 15, 1935 - October 22, 2006

*They say there is a reason,  
They say that time will heal,  
But neither time nor reason,  
Will change the way I feel,  
For no-one knows the heartache,  
That lies behind my smile,  
No-one knows how many times,  
I have broken down and cried,  
I want to tell you something,  
So there won't be any doubt,  
You're so wonderful to think of,  
But so hard to be without.*

**YOUR LOVING WIFE AND FAMILY**

**Mary Ellen ANDREWS**



Mary Ellen Andrews passed away suddenly on Friday, Oct. 7 at the age of 77 at St. Paul's Home, Bury. She was the daughter of Irving and Mildred (Gorham) Andrews. She leaves to mourn her children Carole, Lynn (Serge), Marc Bissonnette (Natalie); sister of Elmer (Sheila), Lionel (Claudette), James (Georgeline), the late Morris (Betty), Peggy (Yvon).

Visitation at la Coopérative Funéraire de l'Estrie, 146 rue Angus N., East Angus, Saturday, Oct. 22, 9 to 10:40 a.m.; 11 a.m. - service at the Catholic Church, 166 rue St. Jean E., East Angus; interment in Westbury Cemetery.

In lieu of flowers donations may be made to St. Paul's Rest Home, 592 Main St., Bury, QC., J0B 1J0 where Mary received excellent care the 3 months she was there - "like living in paradise" (her words).

Mary was a very kind, thoughtful, generous person always ready to lend a helping hand. She will be sadly missed by all who knew and loved her.



# Affairs revealed

FRIDAY, OCTOBER 21, 2016

## Dear Annie

**Dear Annie:** My wife and I were married for 61 years. We had three sons. "Mary" passed away this year from complications of Parkinson's and dementia.

Mary and her friend "John" had a relationship most of our married life. She had gone to school with John and renewed their "friendship" soon after we were married in the 1950s. I only discovered all this about 10 years ago by finding John's name on telephone calls he'd made to our home. I could not act on it then because my wife was having cognitive impairment, which soon developed into dementia.

In the past, I had thought something was wrong with our marriage and asked my wife several times whether she wanted out, but she just said no. Maybe that was because in our generation, there was a stigma around getting divorced, or it could be that John's wife refused to give him a divorce.

It has devastated me, as I always thought my wife loved me. Evidently, she loved another man. Therapy did not help; I tried that. I cannot describe the hurt. My sons and their families do not know anything about this, and I cannot tell them, as they all loved my wife. — Sleepless in Anywhere, USA

**Dear Sleepless:** I can't imagine what you're going through. My heart goes out to you. You're right not to

tell your sons about their mother's affair, as that would benefit no one. Time is the only thing that will ease your pain.

And it might offer you some comfort to know you're not alone. Just this week, I received the following letter.

**Dear Annie:** My wife of 59 years passed away three weeks ago. While going through her things after her death, I came across her diaries. She kept these her whole life. The worst mistake I have ever made in my life was to read these diaries.

I thought we had a very satisfying married life. We continued having sex well into our 70s. Thirty years ago, while I was away on a business trip, she and a friend went out barhopping. She met a guy whom she described as "a very caring and sexual man." She wrote, "He brought out feelings in me that I never thought I'd have." This man swept her off her feet, and she proceeded to have sex with him multiple times over the next month. She raved about how good the sex was.

During this time, we also had sex with each other at our usual frequency. At that time, she was 48 years old. She was beautiful. She could have passed for 28. She was an upstanding member of the community, was involved in various organizations and was a grandmother

of two.

I cannot get over this affair. I cannot sleep or eat. I keep visualizing what they were doing. This knowledge, on top of my grieving for her, is leaving me sick. There is no one I can talk to about this. I don't want the kids to know about it. I have always loved her deeply. In my heart, I have forgiven her.

Annie, what would make a woman who seemed otherwise stable and satisfied do something like that? What can I do to ease my pain? I cannot get this out of my mind. — Sick and Hurt

**Dear Sick:** I'm so sorry for your loss.

I don't know why your wife did what she did. Perhaps it was a midlife crisis and she wanted to feel desirable and young. But what she described in those pages was infatuation, not love. The terms might appear together in a thesaurus, but they have little to do with each other where it really counts.

Infatuation is intense, passionate and superficial. Love is patient, strong and selfless. It is the most profound kind of friendship. Infatuation fades with time; love only grows deeper. Infatuation's got nothing on love. Those few weeks several decades ago cannot negate the lifetime of happiness you shared. May your wife rest in peace. I wish you all the best.

Send your questions for Annie Lane to dearannie@creators.com.

## Your Birthday

FRIDAY, OCTOBER 21, 2016

Stand tall and look for answers. Take note of what others do and say, and make decisions based on what will work best for you. Walk away if pressure or force is being applied. Deal with institutions and authority figures cautiously.

**LIBRA** (Sept. 23-Oct. 23) — Don't expect others to agree with you or give you handouts. Emotions will be difficult to control. Back away before you end up saying or doing something you'll regret.

**SCORPIO** (Oct. 24-Nov. 22) — It's important to do sufficient research before you make a move. Let your unique style lead the way. Less talk and more action will bring results.

**SAGITTARIUS** (Nov. 23-Dec. 21) — Be prepared to make changes that will improve your current living arrangement. Fixing up your surroundings or sharing your space with someone special will improve your day. Love is in the stars.

**CAPRICORN** (Dec. 22-Jan. 19) — Concentrate on what you can do for others, not on how you can dismantle someone's dreams. Offering constructive suggestions and worthwhile solutions will help you avoid a fight and gain respect.

**AQUARIUS** (Jan. 20-Feb. 19) — You can offer help without letting it cost you financially. A partnership can be formed that will change your life. Romance will bring a renewed commitment.

**PISCES** (Feb. 20-March 20) — Partnerships will be daunting if you cannot bring yourself to stand up for your rights. Step back and re-evaluate the importance of troubling personal or professional connections.

**ARIES** (March 21-April 19) — Emotional matters will escalate quickly. Think before you tackle something that you aren't ready to deal with. Formulate the best way to keep the peace and solve the problem.

**TAURUS** (April 20-May 20) — Getting together with peers, family or people you can learn from will lead to new opportunities and greater self-awareness. Don't fear doing things differently or going it alone.

**GEMINI** (May 21-June 20) — Develop an idea you have been contemplating in order to discover what you will need to bring your plan to fruition. Discuss possibilities with someone you trust.

**CANCER** (June 21-July 22) — Over-spending, overdoing it and being indulgent will add to your stress. Do your best to be moderate and willing to listen and learn.

**LEO** (July 23-Aug. 22) — Don't take no for an answer. Your persuasive skills will help you get your way and enforce new plans. Love and romance will improve your life and bring you satisfaction and happiness.

**VIRGO** (Aug. 23-Sept. 22) — Look for advice from someone who has more experience than you. You may not like what you hear, but it will help you come up with a beneficial plan.

## The best answers since sliced bread

ASK MR. KNOW-IT-ALL

By Gary Clothier

**Q:** The greatest invention since ice cream is cookie dough ice cream. If you took that cookie dough and dropped in onto a baking sheet, would it really bake into a cookie? — G.S.P., Bennington, Vermont

**A:** It took me a while to come up with an answer to this question. Then I came across an article by Andy Kryza of Thrillist, who pondered the same question. He actually tried it using Ben & Jerry's Cookie Dough Ice Cream. The cookies were small and crisp, but they were tasty. Kryza also baked an entire pint of cookie dough ice cream, and reported that it tasted like warm vanilla pudding.

\*\*\*

**Q:** I know the study or collection of flags has a strange name. I would like to know the name, but just as important, what is the origin of the word? — R.B., Corsicana, Texas

**A:** The study of flags is "vexillology," while a person who studies flags is a "vexillologist." The art of designing flags is "vexillography," and the person who does the design is a "vexillographer." One more? If you are an admirer of flags, you are a "vexillophile."

The term vexillology was created in 1957 by U.S. flag researcher and historian Whitney Smith. To create the word, he combined the Latin root "vexillum" (flag) and the Greek suffix "logia" (study).

\*\*\*

**DID YOU KNOW?** Daniel Craig is the first Bond actor to have been born after the Bond series began. Craig was born in 1968, while the first Bond film, "Dr. No," was released in 1962

\*\*\*

**Q:** I was sorry the TV series "Crossbones" was canceled. The show was about the notorious English pirate Blackbeard and starred John Malkovich. The series ended with Blackbeard walking along the beach of an island. What really happened to him? — C.K., Oxnard, California

**A:** Edward Teach (c.1680–1718) is better known as Blackbeard. He operated around the West Indies and the eastern coast of the American colonies. Of course a pirate needs a pirate ship, so he captured a French merchant vessel, renamed it Queen Anne's Revenge, and equipped it with 40 guns. Queen Anne's Revenge hit a sandbar near Beaufort, North Carolina, in 1718, less than a year after he captured it. While there, Teach and his men fought a battle with a small force of soldiers and sailors sponsored by the governor of Virginia. Blackbeard was killed on Nov. 22, 1718. He was romanticized after his death and became the inspiration for a number of pirate-themed works of fiction.

## Happy 80th birthday



Happy 80th birthday to our wonderful parents, **Bert Luce** (October 24) and **Lois (Cutts) Luce** (December 12).

We wish you health, happiness and love, today and always.

Your loving family,  
Elizabeth and David, Heather, Allison  
and Joe, Jennifer and Rodney  
and your nine grandchildren  
and three great-grandchildren.

### CELEBRITY CIPHER by Luis Campos

Celebrity Cipher cryptograms are created from quotations by famous people, past and present. Each letter in the cipher stands for another.

“ ‘ NFXBXULN ’ XH HJZL CA CDCTXAU  
EIMWYZN, CAK X NLXAV XN MEYAYK  
JE KMMIH PMI CBB MP JH ZCHN  
DYDOYIH. ” — VYBBCA BJNT

Previous Solution: “She’s a unique girl; you really don’t meet many people Kristen (Stewart).” — Robert Pattinson

TODAY’S CLUE: B equals O

### CELEBRITY CIPHER by Luis Campos

Celebrity Cipher cryptograms are created from quotations by famous people, past and present. Each letter in the cipher stands for another.

“ ZIURUOLZ, VOVUK. VKTZLJF JKXUKO.  
KT HVZZJF LTI MJFPJBZ ZLJ XVN UC,  
UZ VRIVNC LVC ZT JKX. ” — IFUZJF  
CZJMLJKUJ HJNJF

TODAY’S CLUE: F equals P

Previous Solution: “Twilight” is such an amazing project, and I think it opened up doors for all of us cast members.” — Kellan Lutz

### REALITY CHECK

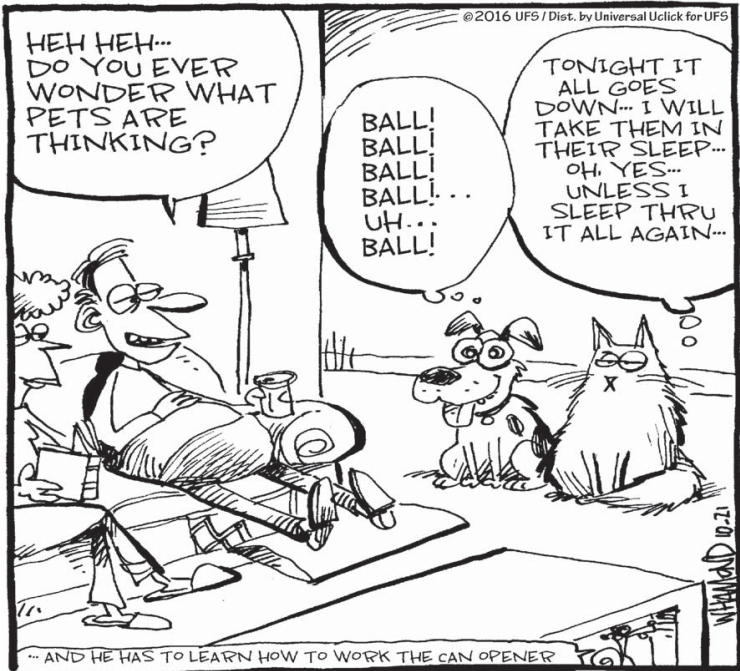

### HERMAN



### ALLEY OOP

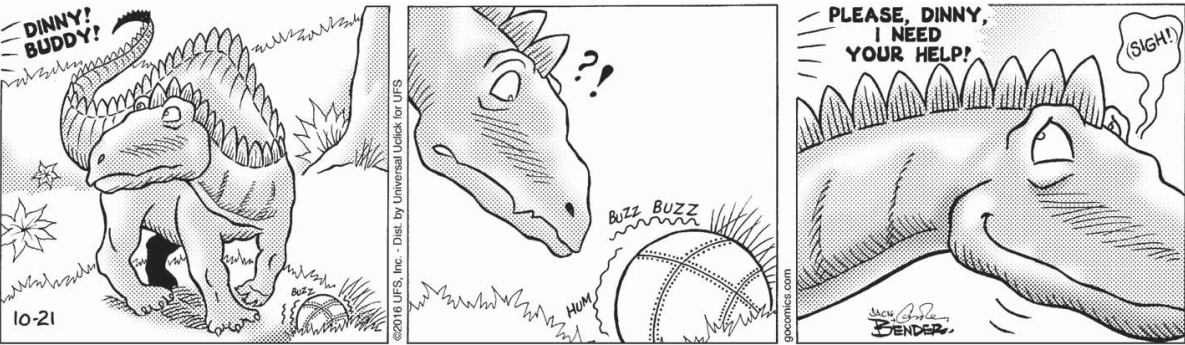

### ARLO & JANIS



### THE BORN LOSER



### FRANK AND ERNEST

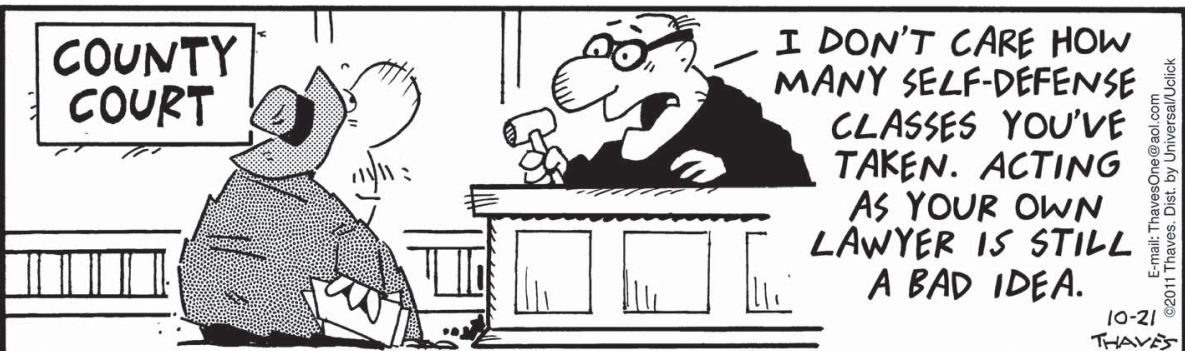

### GRIZWELLS

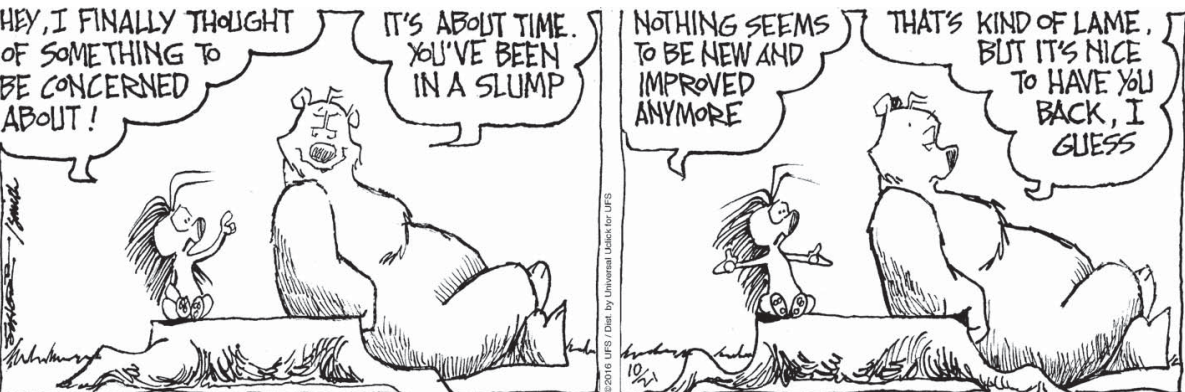

### SOUP TO NUTS

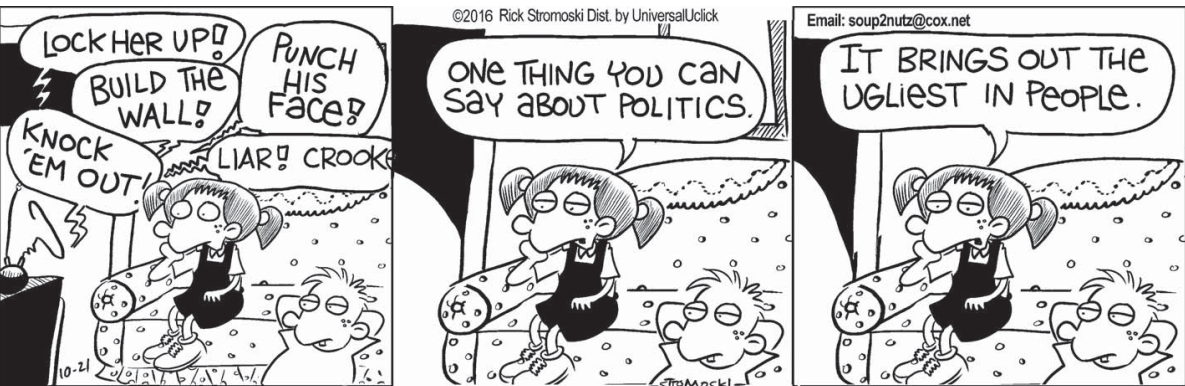

**Diabetes The New EPIDEMIC**

Diabetes Québec  
Information and donations:  
(514) 259.3422 or 1.800.361.3504  
www.diabete.qc.ca

REACT NOW!

CALL SHERBROOKE: (819) 569-9525 BETWEEN 8:30 A.M. AND 4:30 P.M.  
E-MAIL: classad@sherbrookerecord.com  
OR KNOWLTON: (450) 242-1188 BETWEEN 9:00 A.M. AND 4:00 P.M.

DEADLINE: 12:30 P.M. ONE DAY PRIOR TO PUBLICATION  
OR MAIL YOUR PREPAID CLASSIFIED ADS TO  
THE RECORD, 1195 GALT ST. E., SHERBROOKE, QUEBEC J1G 1Y7

# CLASSIFIED

**001** Property for Sale



**Make your classified stand out**, add a photo for \$10. per day. Deadline: 2 days before publication. Drop by our office in Sherbrooke or Knowlton. **819-569-9525. classad@sherbrookerecord.com**

**035** For Rent

BEDFORD - NICE LOFT/MOTEL for rent, fully furnished, heated, electricity, internet acces, stove and fridge included. Available now. Can rent by week or by month. Call 514-226-1531 James or 438-349-2345.

**CLASSIFIEDS ONLINE!**  
www.sherbrookerecord.com

SHERBROOKE - NORTH WARD. 4 1/2 and 7 1/2. Heated, with internet. Quiet building. No big dogs. Call (450) 672-1263 or (819) 565-3029.

**050** Rest Homes

WARBURTON RESIDENCE has 1 private large room in a family home near Lennoxville for convalescing. Personalized care, home cooking. References available. Very reasonable rates. For a visit call 819-563-1388.

**065** Storage

NEW HEATED & CLIMATIZED storage lockers, also standard lockers. Outside RV storage and car storage. **Mini Entrepotage Lennoxville**, 819-562-8062, Jim.

**095** Career Training

**MEDICAL TRANSCRIPTION!** Employers have work at home positions available. Get online training you need from an employer trusted program. In-demand career! Visit CareerStep.ca/AtHome or 1-800-272-7617 to start training for your work-at-home career today.

**100** Job Opportunities

**LITERACY IN ACTION** is hiring a part-time, bilingual **Office Assistant**. Flex-hours (10-16 hours per week). \$15 per hour. Deadline: October 28 at noon. For more details, please email info@literacyinaction.info

**MANOIR ST. FRANCIS - Night Attendant** position open. Are you a real night owl? Apply now and be part of a great team! 125 Queen St, Lennoxville, 819-562-0875.

**100** Job Opportunities

**PART-TIME COOK** needed in Lennoxville. Starting salary \$12.50 per hour, increases with experience. Wednesday, Friday and Saturday nights, approx. 15 to 20 hours per week. Call 819-437-4822.

**SEEKING LIVE-IN CAREGIVER**, assist senior woman in Bromont in private home. Keep records of daily activities, provide personal care; plan, prepare and serve meals; housekeeping and maintain. Room and board, vacation 1 day/month, first year 4% wages. English speaking. Completion of secondary school, first aid and CPR training. Min. one year experience as full time care giving home support, and related occupation. Temp employment contract of 2-4 years, 40 hrs/week, \$12.50 per hour. Please send cv to sdionp3@gmail.com

**100** Job Opportunities

**100** Job Opportunities

## URGENT



is **urgently** searching for carriers in and around **Sawyerville**

**(Routes can be divided)**

**Motorized carrier(s)** for Ch Sawyerville, Dawson, High Forest, Johnson, Jordan Hill, Laberee, Lachance, Lapointe, Lowry, Luce, Route 210 (26 customers)

**Walking carrier(s)** for: Bedard, Church, Clifton, Cookshire, de la Station, High Forest, Hurd Hund, J.A. Lowry, Lisée, Principale North & South, Saint-Germain, Randboro (35 customers)

If interested in any of these routes, please contact our offices at **819-569-9528**

between 9 and 4:30 or by email at **billing@sherbrookerecord.com**

**140** Prof. Services

**CONSTRUCTION O. BEAR INC.**  
SLATE ROOF REPAIR  
Consultation and new installation  
www.constructionbear.com  
**8 1 9 6 4 0 . 4 1 0 0**

**145** Miscellaneous Services

**LENNOXVILLE PLUMBING.** Domestic repairs and water refiners. Call Norman Walker at 819-563-1491.

**150** Computers



**Make your classified stand out**, add a photo for \$10. per day. Deadline: 2 days before publication. Drop by our office in Sherbrooke or Knowlton. **819-569-9525. classad@sherbrookerecord.com**

**190** Cars For Sale

**CLASSIFIEDS ONLINE!**  
www.sherbrookerecord.com



**Make your classified stand out**, add a photo for \$10. per day. Deadline: 2 days before publication. Drop by our office in Sherbrooke or Knowlton. **819-569-9525. classad@sherbrookerecord.com**

**195** Trucks For Sale

2000 FORD F150, 4.6, automatic, 4x4, \$1,200. Also 2003 Chevy Impala, 3.4L, automatic, clean, \$1,500. Call 450-243-0290.

**275** Antiques

WE BUY from the past for the future, one item or a household, attic or basement, shed or garage. We like it all, give us a call. 819-837-2680.

**140** Prof. Services

**290** Articles For Sale



**Make your classified stand out**, add a photo for \$10. per day. Deadline: 2 days before publication. Drop by our office in Sherbrooke or Knowlton. **819-569-9525. classad@sherbrookerecord.com**

**294** Events

**CLASSIFIEDS ONLINE!**  
www.sherbrookerecord.com

**330** Pets



**Make your classified stand out**, add a photo for \$10. per day. Deadline: 2 days before publication. Drop by our office in Sherbrooke or Knowlton. **819-569-9525. classad@sherbrookerecord.com**

**340** Garage Sales

**LENNOXVILLE** Indoor moving sale. Everything must go! Friday, October 21, 8 a.m., 36 Vaudry, Apt. 3, Lennoxville. The "Downs" final sale!

**340** Garage Sales

**LENNOXVILLE Mega Moving Sale at the Montgomerys'** on Saturday, October 22 at 3645 Glenday Road, Lennoxville, 8 a.m. to 5 p.m. Rain or shine, indoors. Store stock from Christian Bookstore, new items priced to go including books, plaques, giftware, candles and Bradford items. Grandfather clock, single beds with dresser, chairs, recliner, secretary desk, pinwheel crystal, Paragon dish set and numerous other household items, some antiques. Table saw, radial arm saw, Shopsmith. Pedestal sink and hot tub. Delivery possible. Let's make a deal!

**RATES**

25¢ per word  
Minimum charge \$7.00 per day Mon. to Thurs., \$8.00 on Fridays, for 20 words or less.  
Discounts for prepaid consecutive insertions without copy change  
3 to 20 insertions - less 10%  
21 insertions - less 20%  
#84 Found - 3 consecutive days - no charge  
We accept Visa & MasterCard  
**DEADLINE:** 12:30 p.m. working day previous to publication.  
Classified ads must be prepaid.

**Thank You For Checking**

Please look over your ad the first day it appears making sure it reads as you requested, as The Record cannot be responsible for more than one insertion.

Looking to rent an apartment? Or want to rent one?  
Place an ad in the classifieds!  
**(819) 569-9525 or (450) 242-1188**

# ATTENTION DEADLINE CHANGES

Please note that for the week of October 24 to 28, 2016

**ALL** our deadlines are moved up to **10 a.m.** for publication the next day.

**The Record office will be closed on Friday, October 28**

*Thank you for your understanding and cooperation.*

THE **RECORD**

Looking for a job or qualified personnel?  
Consult our Classified ads!

**Want your ad to stand out?**

For **.50** a word - **bold** it.

CLASSIFIED

**ENCAN SAWYERVILLE INC.**  
presents

Sat., October 29 at 12:30 p.m.

**CONSIGNMENT SALE OF BEEF COWS and REPRODUCTION BULLS**

79 head of animals are already registered for this sale and will be sold at the beginning of the auction:

**MARIE-PAULE BILODEAU & MARCEL BERNIER of Ste-Agathe de Lotbinière:** A very good herd of 40 Ch and Ch-cross cows, bred purebred Sim., due as of February. 7 will be sold with their 250 lb calf and re-bred purebred Shorthorn. 3 excellent purebred bulls: 1 3-year old Sim., 1 2-year old Ch. and 1 1-year old Shorthorn. Herd is de-wormed and vaccinated Triangle 9 yearly.

**MARCO RICHARD of Lambton:** A complete herd of 15 very good Ch and Ch-cross cows, 3 are Sim., due between December and February, 4 at their 2nd calf. Bred Lim purebred registered.

**FERNAND BEAUREGARD of Sherbrooke:** Complete tied herd of 13 young very good quality cows (8 Angus and 5 Ang-Sim), due in Feb-March, at their 2nd and 3rd calves. A good 2 1/2 year old Limousin bull.

**A SALE NOT TO BE MISSED!**

NOTE: Reception of animals will be 7 a.m. to noon the day of the sale. Gestations will be verified by a qualified veterinarian



Call us! 819-849-3606  
420 Rte 253 S., Cookshire-Eaton  
www.encansawyerville.com

**AUCTION for GUYLAINE PARENTEAU**

11225 ch. Fairfax, Stanstead East  
Sunday, October 23, 2016 t 10 a.m.

**TO BE SOLD:** antiques: rocking chair; tools; 5 stained glass windows; chairs; cast iron kettles; wash board; sandstone jars; decorative articles; armoires; boiler; tubs; dishes; crystal; trunks; wooden barrels; bureaus; mirrors; demijohns; armchairs; milk cans; wicker chair and swing; snowshoes; kettle; tobacco cutter; bottles; china cabinet. **OTHERS:** 2 sets of scaffolding; Craftsman 16hp lawn tractor; garden trailer; 2 gas hedge trimmers; ladder; lawn roller; patio furniture; Husqvarna 257 chain saw; sub pump; plastic and steel culverts; metal pickets; ABRI TEMPO; dolly; gas patio heater; outdoor fountain; rolls of fencing; garden tools; cement mixer; racking; 4 in. conveyor; band sander; saw bench; lot of mechanics and workman's tools; grindstone; vise; jacks; Snap-on lamp and heater; loading ramps; cat or skunk cages; stuffed bear; animal skins; antlers; fishing equipment; naturalized birds; 4 winter tires on rims 215-75-R15- for Jeep. 2-door refrigerator; microwave; 24 in. flat screen TV; home theater; Whirlpool washer-dryer; floor polisher and carpet cleaner; stereo system; radio cassette player; kitchen articles; sewing machine; file cabinets; lot of wooden ducks; coat stand; collection of salt and pepper shakers; bedding; weather vane and lots of other articles too long to list.

**BERNARD VANASSE, Auctioneer**  
www.encanbernardvanasse  
819-835-9326 • 819-620-2574  
Heated tent in case of bad weather.

Notice is hereby given that, following the death of **Elaine EVANS**, during her lifetime residing and domiciled at 26 Deacon Street, Sherbrooke, Quebec, J1M 2B1, which occurred on August 12, 2016, an inventory of the deceased's property was signed on October 13, 2016, before Mtre Timothy LEONARD, Notary, in accordance with the law.

This inventory may be consulted by all the interested parties, at the office of **Mtre Timothy LEONARD, Notary**, at 520 Bowen South, Sherbrooke, Quebec J1G 2E1, 819 563-0500.

This October 14, 2016  
**Timothy LEONARD, Notary and Attorney for the Liquidator**

**Don't get mad!  
Put a classified ad  
and get results!**



**PUBLIC NOTICE APPLICATION FOR MINOR EXEMPTION**

This application for a minor exemption will be heard at a sitting of Council to be held on November 7, 2016 at 7:00 p.m. at the Buchanan Hall, Centre Lac-Brome, 270, Victoria Street, Brome Lake.

Persons interested by this application are invited to attend this meeting and communicate their observations.

**Application no. 326**

710 Lakeside Road, lots 4 265 204, 4 265 364, 4 265 365, 4 265 198, 4 267 104, 4 267 210 to 4 267 221, 4 267 738, 4 267 739 and 4 267 742, zone UV-9-F14, Foster district

**Nature and effects of the application:**

Request to create campsites and access roads in the protected shoreline at a distance of 10 metres from the highwater mark of the watercourse and wetlands. Article 80 of Zoning by-law 596 sets the protected shoreline at 45 metres from the highwater mark in the RBE-1-E16 zone.

**Application no. 327**

572 Lakeside Road, lots 5 685 797 and 5 685 798, zone RBE-3-F16, Foster district

**Nature and effects of the application:**

Request to install 3 signs, 2 located on posts and one flat on the building. Annex IV of Zoning by-law 596 allows only 1 sign per establishment in the RBE-3-F16 zone. The surface area of the sign on the front of the building is 3.96 square metres whereas Annex IV sets the maximum area at 1 square metre. One of the signs on posts would be located entirely within the protected shoreline of Brome Lake, contrary to the provisions of the Zoning by-law regarding works permitted in the protected shoreline.

Given at Brome Lake  
This October 18, 2016  
Edwin John Sullivan, B. Sc. LL. B.  
Attorney  
Town Clerk

**To All Good-hearted Men:  
Well, perhaps,  
sometimes**

She will always want to feel precious and wanted,  
But do not crowd her to the point she feels haunted;  
Well, perhaps, sometimes!

She will in time decide what are your main faults,  
But don't expect that if you disagree, it all halts;  
Well, perhaps, sometimes!

She will gladly list all your manly duties for any day,  
But will it help if you ask to go out just to play?  
Well, perhaps, sometimes!

She will also make your heart melt when she is in a good mood,  
But because of ill-thought words that may to her sound a bit rude;  
Well, perhaps, sometimes when all else is cozy and right,  
She may surprise you and make you exclaim, "Oh what a night!"

G.L. Brown

**EMAIL YOUR CLASSIFIED TO US!**

Fast and convenient!  
classad@sherbrookerecord.com

**Classifieds Work!**  
(819) 569-9525  
(450) 242-1188

Selling or buying?

**Spread the WORD!**

Whatever you want to sell, whatever you want to buy, you can't go wrong with The Record classifieds. Reach out to hundreds of readers and watch the word get around.



819-569-9525  
450-242-1188

101

Math solves problems

- You have 9 teenage boys and a few seconds to divide a pizza equally. Too late.

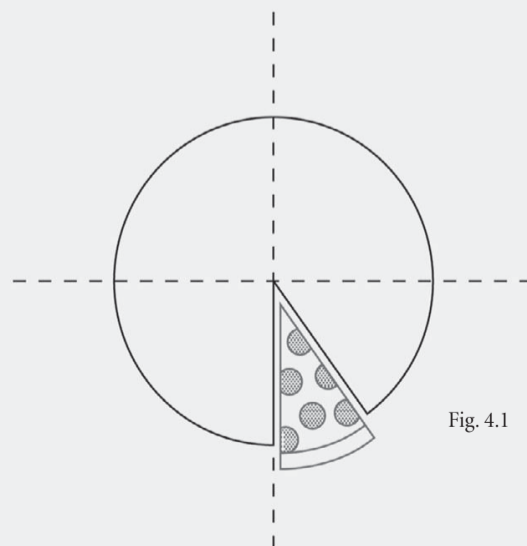

Fig. 4.1



For millions of Canadians, easy as 1-2-3 isn't. If you need help with everyday math, visit mathliteracy.ca or call 1-800-303-1004.

# Your Birthday

SATURDAY, OCTOBER 22, 2016

Carry out changes based on what will make you most comfortable. A problem with someone who is trying to push you in a direction you don't want to go will have to be resolved if you plan to remain in touch. Focus on making personal improvements and developing healthy relationships.

**LIBRA** (Sept. 23-Oct. 23) — Follow a dream and explore how you can turn something you love doing into a profitable venture. Don't let anyone discourage you from at least checking out the possibilities out there.

**SCORPIO** (Oct. 24-Nov. 22) — Refuse to let your emotions take control when restraint and mindfulness are what's needed. Observe, take notes and plan your strategy behind closed doors. Protect your reputation.

**SAGITTARIUS** (Nov. 23-Dec. 21) — An emotional situation revolving around money, a joint venture or someone else's estate or responsibilities is best handled quickly to avoid any misgivings or outside interference.

**CAPRICORN** (Dec. 22-Jan. 19) — Keep an open mind when dealing with friends, relatives or partners. If you try to compromise and meet others' demands halfway, you will avoid emotional turmoil. Travel delays are apparent.

**AQUARIUS** (Jan. 20-Feb. 19) — Share your financial ideas or make changes to the way you handle your money to ensure that you are safe and secure. Make romantic plans for two and celebrate your

good fortune.

**PISCES** (Feb. 20-March 20) — Take a look inward and assess what you see. If you aren't happy with your mental, financial or physical state, do something about it. It's up to you to make things happen.

**ARIES** (March 21-April 19) — Be careful around influential or authoritative people, or you may end up becoming a scapegoat. Listen and observe, but don't share your opinions. Focus on personal achievement and a loved one.

**TAURUS** (April 20-May 20) — You will face delays when traveling if your planning is careless. Visiting places or engaging in events that will introduce you to a different culture is favored.

**GEMINI** (May 21-June 20) — Someone in control of a situation that affects you will not be forthcoming with information you need to make a good decision. Trust your gut in order to do the right thing.

**CANCER** (June 21-July 22) — Sign up for something different in order to gain insight into new possibilities. Don't fight the impossible, and look for ways you can turn a last-minute change to your advantage.

**LEO** (July 23-Aug. 22) — Don't reveal your secrets until you are good and ready. Someone will divulge your plans, putting you in an awkward position. Personal improvements will turn out well. Romance is encouraged.

**VIRGO** (Aug. 23-Sept. 22) — You can offer help, but make sure you get something in return. Sign up for an event or activity that will challenge you physically in order to ease your stress.

FRIDAY, OCTOBER 21, 2016

# The same road, but harder to see

by Phillip Alder

Alexis Carrel, a French surgeon and biologist who was awarded the Nobel Prize in Physiology or Medicine in 1912, said, "To accomplish our destiny it is not enough merely to guard prudently against road accidents. We must also cover before nightfall the distance assigned to each of us."

The declarer and the defense know the distance assigned to each of them in a deal, and each hopes to cover that distance by nightfall — trick 13.

How can South finish the race first in today's deal? He is in six spades, and West leads the diamond queen to dummy's king.

North gambled slightly by jumping to four no-trump, because South might have had two (or three) low clubs. But here it worked out.

South has two minor-suit losers and only 11 winners: six spades, three hearts and two diamonds. Since declarer needs to establish dummy's fifth club, he must ruff three clubs in his hand. This requires four dummy entries — three for the ruffs and one to reach the club queen. What are they?

Declarer immediately concedes that club trick. Suppose East wins and returns a diamond. South takes that trick on the board (entry one), ruffs a club high, plays a spade to dummy's jack (entry two), ruffs

|                   |      |       |            |
|-------------------|------|-------|------------|
| North 10-21-16    |      |       |            |
| ♠ Q J             |      |       |            |
| ♥ A Q 5           |      |       |            |
| ♦ A K 6           |      |       |            |
| ♣ Q 10 7 3 2      |      |       |            |
| West              |      |       | East       |
| ♠ 7 6 3           |      |       | ♠ 8 4      |
| ♥ 9 8 2           |      |       | ♥ 10 7 6 3 |
| ♦ Q J 10 9        |      |       | ♦ 8 5 2    |
| ♣ 8 5 4           |      |       | ♣ A K J 9  |
| South             |      |       |            |
| ♠ A K 10 9 5 2    |      |       |            |
| ♥ K J 4           |      |       |            |
| ♦ 7 4 3           |      |       |            |
| ♣ 6               |      |       |            |
| Dealer: South     |      |       |            |
| Vulnerable: Both  |      |       |            |
| South             | West | North | East       |
| 1♠                | Pass | 2♣    | Pass       |
| 2♠                | Pass | 4NT   | Pass       |
| 5♦                | Pass | 6♣    | All Pass   |
| Opening lead: ♦ Q |      |       |            |

a club (happy to see both opponents follow suit), leads a spade to dummy's queen (entry three), and ruffs a third club.

Almost home, declarer draws West's last trump, plays a heart to dummy's queen (entry four), and discards his last diamond on the club queen (or, if he is a show-off, the club two!).

# CROSSWORD

**Across**

- 1 Deceptive operation
- 6 Work with a number
- 10 Deceptive distortion
- 14 Indulge
- 15 Probe-launching org.
- 16 Words often after a number
- 17 Place to take a 36-Down
- 19 Attire
- 20 Euripides drama
- 21 Cook books, say
- 22 Venomous reptile
- 25 Place to run a 36-Down
- 28 Horror film reaction
- 30 Way out
- 31 \_\_\_ Throne: "Game of Thrones" monarchy
- 32 They may span decades
- 34 Tack on
- 37 Place to install a 36-Down

- 41 Pasture parent
- 42 Members of an exclusive league
- 43 Pasta choice
- 44 Lack of focus
- 45 See 12-Down
- 47 Place to hold a 36-Down
- 52 PC file extension
- 53 One percent, so to speak
- 54 Lead-in to a drink?
- 56 Fund-raiser, perhaps
- 57 Place to hit a 36-Down
- 62 "Totally!"
- 63 Brink
- 64 Mill output
- 65 Not
- 66 Wolfish look
- 67 Neighborhood posting

- 24 Essay makeup
- 26 Locking blocks
- 27 End-of-term ordeal
- 29 Letterpress need
- 32 VP after Hubert
- 33 Expert
- 34 Fairy-tale intro words
- 35 Do a juice cleanse, say
- 36 Theme of this puzzle
- 38 El Niño feature
- 39 Female gamete
- 40 Action film weapon
- 44 Mendel's science

- 45 Novelist Waugh
- 46 Wave to from the dock
- 47 Initiated
- 48 Andean transport
- 49 Edmonton NHL player
- 50 Hull region
- 51 Deduce
- 55 Sigh-inducing
- 57 Holder of locks
- 58 Shelley work
- 59 Scheider of "Jaws"
- 60 Seek payback, maybe
- 61 Fumble, e.g.

**Down**

- 1 "\_\_\_ Hate Me": Spike Lee film
- 2 Prom duds
- 3 Devil
- 4 Social convention
- 5 Country bordering three seas
- 6 Kickoff
- 7 Grab for clumsily
- 8 "Royal Pains" network
- 9 Declare
- 10 "Well, whoop-de-do"
- 11 Get duded up
- 12 With 45-Across, "The Bicentennial Man" author
- 13 Up \_\_\_
- 18 Deadwood's state: Abbr.
- 21 Like new bills
- 22 Out of the way
- 23 Nag

|   |   |   |   |   |   |   |   |   |   |   |   |   |   |   |   |   |   |
|---|---|---|---|---|---|---|---|---|---|---|---|---|---|---|---|---|---|
| A | C | T |   | C | O | S | M | I | C |   | J | C | T | S |   |   |   |
| B | R | O |   | A | R | E | O | L | A |   | O | A | H | U |   |   |   |
| C | O | T |   | V | A | L | U | E | S |   | Y | S | T | E | M |   |   |
| T | W | A | S |   | T | E | N |   | H | A | H | A |   |   |   |   |   |
| V | E | L | C | R | O | S | T | R | I | P |   | M | A | W |   |   |   |
|   |   |   |   | H | E | R |   |   | E | N | S | L | A | V | E |   |   |
|   |   |   |   | B | O | O | B |   | R | E | N | O |   | O | R | E | L |
| V | I | L | L | A | G | E | V | A | N | G | U | A | R | D |   |   |   |
| E | D | D | A |   | O | P | A | L |   | E | I | N | S |   |   |   |   |
| R | E | F | R | A | M | E |   |   | E | R | S |   |   |   |   |   |   |
| A | T | E |   | V | O | L | C | A | N | I | C | A | S | H |   |   |   |
|   |   |   |   | L | A | I | R |   | H | U | T |   | K | I | T | E |   |
| V | U | L | G | A | R | L | A | T | I | N |   |   | O | O | F |   |   |
| I | N | O | T |   | A | U | R | O | R | A |   |   | L | I | T |   |   |
| M | O | W | S |   | H | I | S | S | E | S |   |   | I | C | Y |   |   |

|    |    |    |   |    |    |    |    |    |    |    |    |    |    |    |
|----|----|----|---|----|----|----|----|----|----|----|----|----|----|----|
| 1  | 2  | 3  | 4 | 5  |    | 6  | 7  | 8  | 9  |    | 10 | 11 | 12 | 13 |
| 14 |    |    |   |    |    | 15 |    |    |    |    | 16 |    |    |    |
| 17 |    |    |   |    |    | 18 |    |    |    |    | 19 |    |    |    |
|    |    |    |   | 20 |    |    |    |    |    | 21 |    |    |    |    |
| 22 | 23 | 24 |   | 25 |    |    |    | 26 | 27 |    |    |    |    |    |
| 28 |    |    |   | 29 |    |    |    | 30 |    |    |    |    |    |    |
| 31 |    |    |   |    |    | 32 | 33 |    |    |    | 34 | 35 | 36 |    |
| 37 |    |    |   |    | 38 | 39 |    |    |    |    | 40 |    |    |    |
| 41 |    |    |   |    | 42 |    |    |    |    |    | 43 |    |    |    |
|    |    |    |   | 44 |    |    |    |    | 45 | 46 |    |    |    |    |
| 47 | 48 | 49 |   |    |    |    |    | 50 | 51 |    |    |    | 52 |    |
| 53 |    |    |   |    |    |    |    | 54 |    |    | 55 |    |    |    |
| 56 |    |    |   |    |    | 57 | 58 |    |    |    |    | 59 | 60 | 61 |
| 62 |    |    |   |    |    | 63 |    |    |    |    | 64 |    |    |    |
| 65 |    |    |   |    |    | 66 |    |    |    |    | 67 |    |    |    |