

FACTORY AUTHORIZED DEALER FOR

TROY BILT

SALES SERVICE PARTS

Alternatives

156 rue Châteauguay St.
Huntingdon, Que. J0S 1H0
Tel (514) 264-6245

THE GLEANER

THE LEADING ADVERTISING MEDIUM IN THE CHATEAUGUAY VALLEY

The name friends recommend

A. E. LePAGE

REAL ESTATE SERVICES LTD.

MARILYN PARTRIDGE

15 King St., Huntingdon 264-4798

119th YEAR HUNTINGDON, Que. Wednesday, April 13, 1983. 20 pages 40 cents



Secure in the knowledge that the school year will finish without more teacher strikes, staff and students followed their normal routine at CVR this week.

No strike planned

Teachers left in limbo as vote rejects report

by JUDY TAYLOR
of The Gleaner

A majority of Quebec's teachers, over-riding the opinion of those in Chateauguay Valley schools, have voted for what a local teachers' union leader describes as

an "unimaginable option" to reject a conciliator's report without any follow-up action in their continuing contract dispute with the Quebec government.

"I am not particularly optimistic," said Alan

Strand, president of the 300 member Chateauguay Valley Teachers' Association on Monday, after the cartel of union leaders announced their position, based on last week's vote in which teachers rejected the

Désilets report while backing off further strike action for the current school year at least.

The CVTA was one of several locals under the Provincial Association of Protestant Teachers which voted in favor of accepting the conciliator's report "under duress" as offering at least some improvements over the Quebec government's decree, Law 105.

At a sparsely attended meeting held on Tuesday April 5 in Howick, the vote was 54 to 17 in favor of accepting the report.

"It was a long meeting - from 4 to 7 p.m. - and there was a lot of discussion. Many members were extremely unhappy, and many others stayed away, perhaps because they felt the results were a foregone conclusion," said Strand.

It was Friday before the province-wide figures were complete enough to indicate that overall, the conciliator's report was rejected by a slim majority of 50.8 per cent.

Translated into a bloc vote formula, the results

See TEACHERS Page 2

Other business:

In other business, the council decided to ask the Ormstown office of the Department of Transport to fill the holes in the Rue de l'Eglise in St-Antoine.

See BUS Page 7

Grants allotted

Elgin's recreation meeting draws scant participation

Two representatives of the Athelstan Sports Association were the only people to make a

representation at the April 5 meeting of Elgin Council, when members of the public had been asked to come and discuss the allocation of a \$1,000 government grant for recreational and cultural purposes.

George Tannahill and Jim Steele were told that their group will receive \$200. The rest of the money will be allocated according to the municipal budget: \$200 to Huntingdon Minor Hockey; \$100 to the Little Green Library; \$100 to

Dairymen's resolution

Smaller quota lots could stop drain from S.W. Quebec

by JUDY TAYLOR
of The Gleaner

In an effort to cut down on inflated prices for milk quota, and on the amount of quota leaving the area, the newly integrated St-Jean-Valleyfield dairy producers' Federation recommends that quota be sold in smaller batches.

A resolution calling for auction lots of fluid and industrial quotas to be halved in quantity was passed by some 200 producers at the first meeting of the new regional federation, held Tuesday, April 5 in Ste-Martine's St-Jean-Baptiste Hall.

If the resolution passes at the provincial level, it would mean that sale totals of 250 kilograms of butterfat (industrial) and 50 litres of fluid milk would be reduced to 125 kg and 25 litres, respectively.

Huntingdon

Council delays Law 101 changes

by CYRIL ALARY
of The Gleaner

Caught between continuing pressure from l'office de la langue

"This would give more buyers a chance at the monthly quota auctions held in each region of the province," said Ormstown's Bill Bryson, president of the

See QUOTA Page 7

française and hints from Quebec minister Gérald Godin that there may be some softening in certain provisions of Law 101, the Huntingdon Town Council continues to keep the French-only issue on hold.

At the April 5 council meeting, alderman Doug Field went on record that his own feeling is that council's answer should be a flat "no" to a demand from the OLF that fire trucks be labelled in French only.

A recent letter from OLF official Richard Bergeron reminded the Town that it has until the end of 1983 to implement the clauses of the French language charter affecting municipal administration.

Council has decided not to make any formal commitment before studying the specific requests in more detail. The "corrections" which have been listed by the OLF include:

• The name of the town and its services (such as traffic tickets and fire

See DELAY Page 5

No nudes is good news

Nude go-go dancers, of whatever sex, are unlikely to be welcome in Huntingdon nightspots.

Notice of motion was given at the April 5 council meeting by alderman Doug Field, indicating that a municipal by-law forbidding this type of entertainment within town limits will be introduced at the next meeting. Field heads the municipal police committee.

The feeling at the council meeting was that anyone wanting to see nude dancers in action has only to go to one of the nearby centres where such entertainment is offered - such as Ormstown, Valleyfield, Dorion or Chateauguay.

\$3,000 deficit

Lions hit skids on Ormstown rink

A winter which just wasn't wintry enough left the Ormstown Arena skating rink, operated by the local Lions' Club, in a severe financial bind.

This was the report brought to the April 5 meeting of the Ormstown Village Council by Lions' representative J.B. Guérin, who indicated that the brief and spotty skating season ended with the rink showing a \$3,000 deficit.

The Village council offered to cover half the deficit, with \$1,500 to be taken from the 1983-84 provincial grant for

See RINK Page 11

la gazette

• Les enseignants ont rejeté à 54% le rapport Désilets.

• Les danseuses nues ne seraient pas les bienvenues à Huntingdon.

• Le Club Optimiste de St-Anicet voit officiellement le jour.

• Le tournoi de hockey des Fragiles remporte un éclatant succès.

• Une nouvelle ligue de balle-motte voit le jour à Huntingdon.

• St-Chrysostôme: suite à un argument, il reçoit une balle dans le dos.

F.C.C. interest rate down

Federal Agriculture Minister Eugene Whelan announced April 1 that the interest rate charged under the Farm Credit Act has been lowered to 12 3/4 per cent from 13 1/4.

"This decrease is a welcome sign that interest rates are returning to a more normal level and that our economy may soon start to recover," said Whelan.

"At the close of its fiscal year on March 31, the Farm Credit Corporation estimated its total loans to Canadian farmers at \$575 million. As a result of the amendments to the Farm Credit Act which allow FCC to supplement its budget with financial

See F.C.C. Page 11

Not worth it

Franklin wants out of MUCTC bus service

At its April 4 meeting, Franklin Council again asked for support from the MRC du Haut-St-Laurent for a request that Montreal Urban Community Transit Commission bus service to the Franklin area be discontinued.

The municipality is not interested in being

Scouts take charge

Clean-up project planned for H'ford

At its April 5 meeting, Hemmingford Village Council supported a project launched by two local Boy Scouts to help residents with spring clean-up.

Jimmy Cotton and Michel Laberge, both of whom are working on their Chief Scout Award, attended the meeting to explain their community project, which will involve giving out garbage bags to residents on Saturday April 30 and picking up the

assessed for part of the deficit which the service incurs, in return for one bus per week which stops in St-Antoine-Abbé, coming from Montreal. There is no ongoing service at all, and studies have shown that perhaps four residents of the municipality travel on the bus.

Other visitors at the council meeting were two representatives of the School Committee of the Académie Langlois, which is planning a skipping marathon in aid of the Heart Fund for Thursday, April 21. The schoolchildren will be skipping from 3 to 6:30 p.m. on that day, and the council was asked to make a donation toward refresh-

See H'FORD Page 9



Promise of spring

Work began last week on the fence surrounding what is to be the tennis courts, part of the new playground and picnic area near Huntingdon's Civic Centre swimming pool. The project is being sponsored by the Huntingdon Rotary Club in co-operation with the Town of Huntingdon.

IN THIS ISSUE

Municipal council reports

Page 9

Sports news

Page 8

4-H Square Dancing

Page 3

Community news

Pages 5, 7, 11

This and That in Town

ON COVEY HILL - a group of residents is anxious to preserve the 126 year-old Wesley United Church building, located below the Covey Hill corners. If the building is to remain standing, a new roof is needed immediately. To this end, a committee has been formed to try and raise about \$1,500 over the next couple of months. Though no regular services have been held in the church for over 40 years, the group feels that former members and people interested in historic buildings will want to lend a hand to help save it. For further information, or to make a donation, contact Fergus Moore [247-3524] or Jean Curran [247-2515].

ON MARCH 31 - The Chateaugay Valley English Speaking Peoples' Association (CVESPA) hosted a Health and Social Services luncheon at the Heritage restaurant outside Huntingdon. Featured speaker was Rita Karakas, director of health and social services for Alliance-Québec. We have been promised a more detailed report in the near future.

SPECIAL GUEST - of the local Parti Québécois riding association of Friday, April 22 will be Quebec's controversial education minister Camille Laurin. He will make an appearance at the Le Relais sugar shack in St-Urbain starting at 7 p.m. In the context of the party's current fund-raising drive, Laurin is expected to speak about his party's intention to base its next election campaign on the theme of Quebec independence.

OPERATION IMPOT - (help with tax forms), a project sponsored by the local ADDS (association for the defense of social rights) has been a great success with over 300 people attending sessions where help in filling out tax forms is available. More such sessions are scheduled for "Welfare Week", April 24 to 30. The service is available free.

IN THE ORMSTOWN AREA - a group of volunteer canvassers and workers, including members of the Ormstown Fire Department, conducted a one-day blitz campaign on behalf of cerebral palsy victims on Sunday, April 10. Working door-to-door and from a central location in the Casa Venezia Restaurant, the group collected \$2,250, bettering last year's total of \$2,015. Organizers expressed gratitude this week to everyone who helped in any way, as well as to donors.

IN DUNDEE - the annual Salvation Army drive sponsored by the Dundee W.I. will be held from the Town Hall on Tuesday, April 19 from 9 a.m. to 5 p.m. For more information, call 264-5853 or 264-4301.

A LAST REMINDER - for the Spring Luncheon this Thursday at the Ormstown Presbyterian Church. For full details, see ad in last week's Gleaner.

AT CVR - last Wednesday, Cpl. Gilles Pelletier of the RCMP was a special guest, talking to Secondary I students and those taking the Law course about drug abuse. Cpl. Pelletier, a sports enthusiast who was at one time posted in Coughnawauaga and who played hockey in Ormstown, has had great co-operation from some NHL hockey stars such as Wayne Gretzky and Réjean Houle in working with young people and educating the public about the dangers of drugs. School nurse Ruth Graham reported that the talk was interesting and well-received by the students. "We'd like people to know that good things are going on with young people, when we hear so much that is discouraging," she said.

A SKIP-A-THON - in aid of the Heart Foundation will be held Thursday, April 21, from 3 to 6 p.m. at the Académie Langlois in Hemmingford. All the pupils are taking part and looking for sponsors to help in this worthy cause. Spectators are also welcome to come out and support the youngsters as they skip.

THE ANNUAL BARN MEETING - of the Huntingdon-Ormstown Holstein Club will be held this Saturday, April 16, starting at 1 p.m. at the St-Etienne farm of Leduc et frères. Club secretary Adrien Knoops says that the Leduc operation is a high quality, purebred N.I.P. herd, classified and P.A.T.L.Q. tested, and following the young sire program under the C.I.A.Q. (Dairy people will know what all these initials stand for.) The Leducs milk about 80 cows, and the meeting should be extremely informative. Any 4-H club members will be welcome to attend. (For further information see ad elsewhere).

Gleaner ads:
Tel. 264-5364

Huntingdon Locals

Recent guests of Mrs. Angus McNaughton were Denton and Shawn Hooker of Mississauga, Ont., Kimberly Hooker of Flesherton, Ont., Mrs. David Kee, Vanessa and Christina of Toronto and Mrs. Garth Coffin and Tricia of Pierrefonds, Que.



Normand Lavoie (left) first president of the newly-founded St-Anicet Optimist Club, made a special presentation of a painting to Optimist District Governor Alain Marceau at the special April 10 meeting at which the club received its charter.

THE FOUNDING MEETING - of Huntingdon's new Resource-Action group will be held tonight (Wednesday) at 7:30 p.m. at the Huntingdon CLSC. First conceived last November as a non-profit organization to promote short-term and emergency measures to combat the economic slump, the group intends to work along with existing community groups, to help the community help itself.

FOR INFORMATION - on the upcoming Card Party for the benefit of the Chateaugay Valley Association for the Mentally Retarded, see the advertisement elsewhere in this week's Gleaner.

THE NEXT MEETING - of the Valleyfield chapter of the La Leche League will be held April 20 from 8 to 10 p.m. at the home of Francine Malenfant, 7 rue Dignard (at the end of rue Leduc) in Valleyfield. For further information, call 373-8695.

Howick

Mrs. Evelyn Lamb

Howick Seniors met on April 6 for an afternoon of games and fellowship as 32 members were welcomed. Winners were: 500 - Jennie McKell; Bridge - Mary McCaig; Euchre - Gordon Hope; Scrabble - Lois Elliot. Refreshments were supplied by Sophia West, Mary McCaig and Muriel Ness. A ration of humorous stories was supplied by Hazel Ness. The Closing Dinner next week is anticipated with pleasure. A donation box for the Mentally Retarded Children will be on hand. Anyone wishing to bring along a door prize will find it appreciated.

AT CENTRE-JARDIN ST-ANICET ENR. FOR QUALITY AND GOOD PRICES

YOU WILL FIND

- TREES
- SHRUBS
- EVERGREENS
- ANNUAL PLANTS
- PERENNIAL PLANTS
- SEEDS
- HERBICIDE
- INSECTICIDE
- FERTILIZERS
- DECORATIVE PLANTERS
- POTTING SOIL

WE ALSO OFFER YOU A LANDSCAPE SERVICE
(PLANTATION AND MAINTENANCE)

FOR ALL YOUR SPRING NURSERY PURCHASES
SHOP AT THE

CENTRE-JARDIN ST-ANICET ENRG.

1047 ROUTE 132 ST-ANICET
CALL 264-6861 264-4140 NIGHTS
LISE AND MARC WART



Learning disabilities discussed at meeting

On April 5, Claire Leblanc, President of the Chateaugay Chapter of the Quebec Association for Children with Learning Disabilities held an information night at the Huntingdon Academy, hosted by the Huntingdon Academy School Committee and the Chateaugay Valley English Speaking People's Association (CVESPA).

Problem identification as well as experiences were discussed among parents present. Some possible steps towards finding a solution were forwarded. What the group now needs is someone to do the work of information gathering. Any volunteers for this job? If you want to help out on the information gathering and planning please contact Donna Thiel at 264-2498 on Monday-Wednesday afternoon or evenings till 8 p.m. If this is not convenient, please post a letter to Box 1557 in Huntingdon.

Teachers...

the results showed a stronger position against the recommendations of the report, while rejecting the strike option.

The motion passed on the weekend by the union cartel contains three main clauses. While rejecting the Désilets report overall, it calls for the implementation of its "positive" effects for the first year of the new contract, while demanding that negotiations be reopened with the government for the two subsequent contract years.

The conciliator's report had recommended that fewer teachers be cut, and that surplus teachers' salaries should be higher than foreseen in the decree.

It would seem that the union leaders would like to see these gains implemented during the next school year while "preparing mobilization"

Disabilities'. Educate yourself before your curiosity. Stop the myths. Please phone ahead before showing up to make sure you will get the information you are seeking and to avoid unnecessary travelling.

Also any parents who are looking for more information regarding learning disabilities are asked to contact Donna Thiel or stop by at the Huntingdon Academy Library at 21 King (264-5482) or at the CVESPA office at 2C Bouchette (264-3152) or contact Claire Leblanc in Chateaugay (691-2304).

Claire Leblanc has left a set of information documents entitled "Information Please" both at the Huntingdon Academy Library and at the CVESPA office. You are welcome to come in and read the documentation. Some titles are: "Learning Disabilities and the School Age Child," "Learning Disabilities: The Search for Causes," "Adolescence and Learning Disabilities: A Time Between", "The Family and Learning

from page 1

to exert pressure for improvements in subsequent years.

But Alan Strand's personal opinion is that the union demands will have little clout in persuading the government to take a softer line in further negotiations, if they occur.

"I'm afraid the damage is done. I feel the symbolic decision to refuse to accept the conciliator's report will have little or no impact on the government, which has become a kind of immovable force. The acceptance of the report would have meant the preservation of almost 3,000 jobs over the duration of the contract, although another 3,000 would still disappear," Strand said.

As the battle continues between teachers' unions and Quebec, staff and students are remaining in the classrooms, doing their best to complete the course of study for the current school year, which seems likely to end without further interruption.

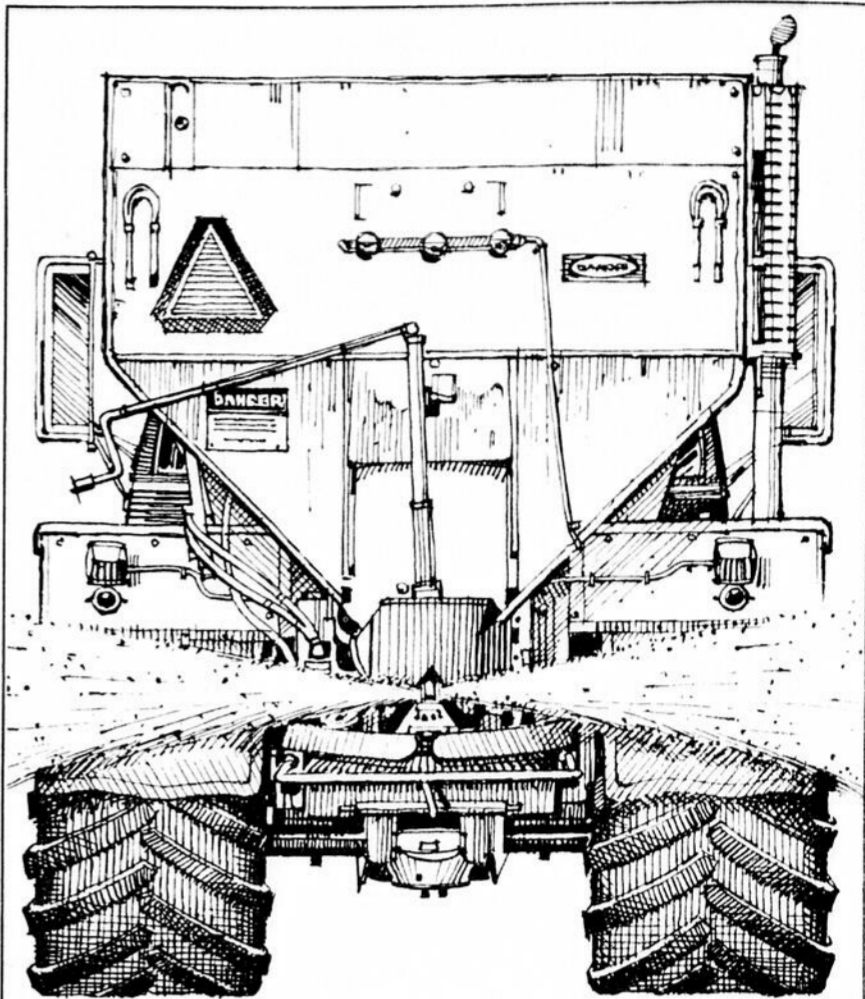

Weed and feed your cornfields in one quick trip.

Get two big spring jobs done fast, right and on time.

First, we impregnate the dry bulk fertilizer of your choice with Sutan™ selective herbicide and atrazine. Then we apply it. You just incorporate the herbicide-fertilizer in one trip.

One spring application of Sutan+ with atrazine gives you effective, full-season control of foxtails, crab grass, velvetleaf, fall panicum, nutsedge, barnyard grass plus a broad spectrum of other grass and broadleaf weeds.

This spring, save time and trouble with our one-trip, weed and feed service. Stop by or call us today. **Sutan+. The best incorporated corn herbicide.**

Sutan and Sutan+ are registered trademarks of Stauffer Chemical Company, U.S.A.

**WE WILL APPLY YOUR FERTILIZERS
AND YOUR CHEMICALS**

YOU CAN SIT BACK AND WATCH US DO IT!!!

MAKE SURE AND RESERVE YOUR TIME NOW!

COMPUTERIZED FERTILIZING PROGRAM

**25 SPREADERS • 2 BULK DELIVERY
UNITS • FAST DELIVERY**

**1475 BOUL. ST-JEAN-BAPTISTE
STE-MARTINE, P. QUE.**

TEL: 427-2132, 427-2136



Ormstown

Mrs. Jean McEwen
Mrs. Bob Perkins, Jason, Billy-Joe and Tracy; Rosie Graves of Athens, Ont.; Mrs. Marilyn Hall, Cheryl and Michael; and Robert Adams of Aston's Corners, Ont. were Easter visitors of Mr. and Mrs. Alvin Gruer and Melvin.

Shoes to wear with everything...and sizes to fit everyone!



\$46.
• BONE
• WHITE

Walkin' Natural with NATURALIZER.

J. Paul Chatel CHAUSSURES - SHOES

199 VICTORIA ST., VALLEYFIELD TEL. 373-1484



Pédigrain Inc.

YOUR DEALERS

LEONARD LEBLANC

264-2119

6034 RIDGE

STE-AGNES

FOR STE-AGNES - ST-ANICET - ELDON - HUNTINGDON

RAYMOND LANIEL

264-4524

LOST NATION RD.

HUNTINGDON

FOR ATHELSTAN - HINCHINBROOKE - HOWICK ORMSTOWN - HUNTINGDON

COMPLETE LINE AVAILABLE

- CEREAL SEEDS STRAIGHT OR MIXED
- FORAGE SEEDS STRAIGHT OR MIXED
- SOYA BEAN • ASGROW CORN • HERBICIDE • PESTICIDE

BELHEN - WICKES

BUILDINGS

ORDER EARLY FOR BETTER SERVICE

IT'S A STEAL!

RIGHT NOW...

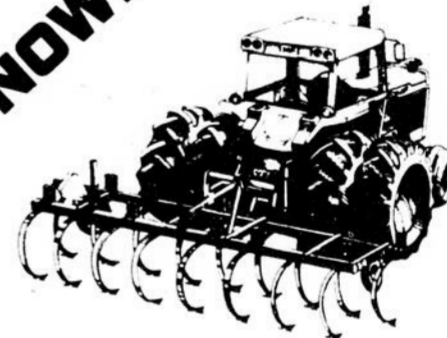

IT'S A STEAL! AT YOUR MASSEY-FERGUSON DEALER. RIGHT NOW! I'M TALKING ABOUT THE BIG FACTORY ALLOWANCES THEY'VE RECEIVED AND ARE PASSING ALONG ON NEW MF TRACTORS, TILLAGE TOOLS AND PLANTERS. NOW I'D CALL ALLOWANCES UP TO NINE THOUSAND DOLLARS A REAL STEAL WOULDN'T YOU? MASSEY IS OFFERING THEM...ON MOST NEW 1982 MODEL MASSEY TRACTORS FROM 34 HORSEPOWER ON UP. AND IF YOU FINANCE THROUGH MASSEY, YOU GET YOUR CHOICE OF SPECIAL LOW ANNUAL PERCENTAGE RATE FINANCING...OR...WAIVER OF FINANCE CHARGES 'TIL JUNE OF '83.

BUT THEY DON'T STOP THERE. THEY HAVE FACTORY ALLOWANCES FROM MASSEY OF UP TO THIRTY PERCENT ON NEW IMPLEMENTS INCLUDING PLOWS, DISC HARROWS, CULTIVATORS, GRAIN DRILLS AND PLANTERS. PLUS THERE ARE SOME GREAT DISCOUNTS AND FINANCING DEALS AVAILABLE ON HAY TOOLS AND BALERS. THEY'VE GOT ALL THE DETAILS ON THESE BIG SAVINGS. BUT I'LL TELL YOU WHAT! DON'T WAIT TOO LONG 'CAUSE THESE "STEALS" ARE LIMITED TO AVAILABLE INVENTORY...

and they're only available up to April twenty-ninth.
**SO YOU'D BETTER HURRY OVER RIGHT AWAY...
GRAB YOUR DEAL... AND RUN!**



OFFER LIMITED TO AVAILABLE STOCK

**LA CIE
LONGTIN INC.**

ST. STANISLAS DE KOSTKA

(514) 373-0717

news from huntingdon's



craft and recreation centre

by Buff Wilson

The nice weather last Wednesday brought a large crowd to the Legion Hall for a full program of band, craft and card activities. Even the Band members, who must have been tired after their very late night the evening before, enjoyed the day's program.

The Kitchen Band presented a musical program last Tuesday before a great audience composed of members of the L'Age d'Or de Notre Dame in Chateaugay. Not only did we have a common interest in music, but we discovered that they do many of the craft and recreational programs done at our own Centre. We are hoping to share some of these interests in the fall when they have their craft exhibit and we our bazaar.

This is the best time to thank our many boosters who travel with the Band, giving us encouragement while at the same time enjoying the contact with new people everywhere we go. I am sure all of the band members would like to join me in thanking Jeanine Robert for her wonderful help in acting as our master of ceremonies on those occasions when our audiences are French-speaking, such as this last one.

The next concert to be presented will be held on Friday, April 15 and the place is St. Lambert. As it is a Friday evening, we are hoping to have a lot of people accompany us who might otherwise be working. There is room on the bus for extras and you can see me or Helen Stewart if you would like to.

Here is good news for all of you who have been eagerly awaiting our trip to Malone to see "Gandhi". The date will be Thursday, April 21, leaving the Legion Hall at 6:15 p.m. to arrive at the theatre in time for the 7:30 p.m. showing. The cost for the bus will be \$3.25, considerably less

than the last theatre night because we are taking a large bus. The list for the movie will be passed around today and next week. Once again we need a full bus-load in order to keep the cost down and non-members are most welcome to come with us. This afternoon, Irene McLean will begin teaching the art of plastic embroidery in preparation for our annual bazaar next fall. At the same time Shirley Schell will be in the back kitchen holding our Blood Pressure Clinic. Try to see her before starting your activities. It would be helpful if the card players were given the chance to proceed through the line first and especially those involved in progressive bridge.

Jessie Amy finished her class in stencil-craft last week and already has ideas for craft projects when she returns in the fall. "Kitchen witches" and bread dough crafts are two more of her areas of interest and that should give you something to look forward to come September.

Close to 60 members and friends of the Centre enjoyed a wonderful meal and afternoon at Somerville's sugar house in Hemmingford last Thursday. It was a time to leave the diets at home and enjoy a satisfying dinner in the company of good friends. Our special thanks go to Vera Dooling who, along with her capable assistant, Bob Brannon, entertained us musically throughout the afternoon.

It gave us a lot of pleasure last Wednesday to extend birthday greetings to Isabel Elder, Lucien Latour, Florence Mayall, Ida McCallum, Evelyn Maither, Edith Thompson, and Hilda Williams. As well, Ethel and Gordon Anderson received our best on the occasion of their 34th wedding anniversary held recently. Congratulations to all of you.

Lachute 4-H club entry takes square dance honors at Howick

by Peter Poupart

A highly successful square dance competition sponsored by the Howick 4-H Club was held on April 9, at the Howick Elementary School. This fifth annual competition attracted over 400 spectators - the largest crowd so far to witness the event.

Seven teams participated in the actual competition - two from Lachute two from Howick and one each from Sherbrooke, Lennoxville and the Townships. For the second consecutive year, a team from Lachute took the trophy for the best team. Lachute's second team took second place and third place was won by the Sherbrooke eight.

An innovation for this year's competition was the introduction of a new trophy for "Best Couple", made and donated by Roy Templeton. The first winners of this trophy were Susan Smerdon and James Naylor of the Sherbrooke team.

Although no trophy was available for younger dancers the audience was particularly appreciative of the performance of the very young dancers from Lachute who gave an ex-

cellent account of themselves and will be dancers to contend with in future competitions. The junior team from Howick composed of Jill Milne, André

Poupart, Katherine Bronn, Sheila Brown, Scott Petrie, Dean Robertson, Brent Peddie and Peter Poupart also gave a good account of themselves and

show great promise for next year.

Judges for the event were Mrs. Dorothy McRae, (Howick), Harold Arnold (Dundee) and Allan Rathwell, of Chateaugay. Master caller for the evening was well-known Howick caller Bob Barr. Music was by the MacKay Brothers with Rev. Larry Paul at the piano.

The Howick 4-H Handicraft Club drawing for a quilt was won by Mrs. Sophia West. The other prizes were won by Mrs. Thyra Tolhurst, Joe Andert and Mrs. Iris Woods.

The Howick 4-H Club would like to particularly thank the parents and merchants who donated food or helped in many other ways.

The masters of ceremonies, who must be credited with keeping the evening running smoothly and efficiently were Larry Ness and Doug Lang.

The only unfortunate

event of the evening was the telling of an old joke, by one who shall remain nameless, which brought

groans from the audience. Really, Larry!! All in attendance agreed that it was the best

competition to date; 2. an enjoyable evening was had by all and 3. all look forward to next year's event.

Rockburn

Diane Farquhar
264-3960

The Franklin Scouting groups held a successful Military Whist recently in the Franklin Elementary School. Twelve tables of card players were on hand from all over the Chateaugay Valley.

Winners of the prizes are as follows:
High: John Howe, Bev Howe, Hilda Williams, Ronnie Williams.

Low: Mary Sloan, Florence Lindsay, Linda Sutton, Thelma Sutton.
Door prizes: cut flowers, Florence Lindsay; plant, Marion Sloan; books, Bev

Howe and Lois Goldie; food basket, Mina Lindsay.

Raffle Prizes: Don McKeeley, Karen Harrison, Ivan Nedsong, Barbara Ednie, Lois Goldie, Muriel Hayward, Ken McDonald, Irma Wallace, Linda Carrigan, Muriel Frier, Maggie Arthur, Isabelle Furey, Beryl English, Hazel Ness, Glenna Blair, Jenny Baird, Ann Rutherford, John Howe, Molly Laine, Linda Sutton, Ronnie Williams, Hank Hirsh.

Many thanks to all who came and to all the folks who donated prizes.

Howick

Mrs. Evelyn Lamb

Hockey and skating have always played a large part in our winter pastimes. We have been hearing about the boys' hockey teams and games, but don't forget that the girls have been busy with figure-skating classes during the cold months. Special presentations will take place by the Figure Skating Club in the Ste. Martine Arena on April 23 and 24. Any friends interested in checking in on the skills gained by the youngsters can get tickets or more details from parents of participating young people - Grace Brown and Penny Anderson, to mention two.

Gleaner ads work wonders

OPENING TOMORROW APRIL 14th

178 Chateaugay, (Currie Building), Huntingdon, 264-4866

- A potpourri of gifts for all ages •
 - Walt Disney Tapes & Records
 - Baby Carriers, Diaper Bags & Travel Cribs by Snuggly
 - Peter Powell Stunt Kites (C'mon - go fly a kite!)
 - 100% Cotton Clothing • Celestial seasonings Herb Teas & Other Imported Teas • Swiss Chocolates • Aunt Martha's Homemade Bread • Many Unique Gift Ideas
- Join us for tea & goodies on opening day. Stay & browse

JEANS

Levi's
STRAIGHT LEG

La
OUÉRASSE
BOOT CUT

Dan Cooper
STRAIGHT LEG

LEMANS

STRAIGHT LEG

GO WEST

MATURE CUT

SEAT COVER

STRAIGHT LEG

19⁹⁹

ALL MADE IN CANADA AND FIRST QUALITY PRODUCTS



ON YOUR MARK

RUNNING SHOES

CHILDREN'S SIZES 3 TO 6
ADULTS SIZES 7 TO 12
COLOR: GREY OR NAVY

\$14⁹⁹



FORSYTHE

SHORT SLEEVE SHIRTS
SIZE SMALL TO X-LARGE
IN MANY COLORS

\$13⁹⁹

TERRA
\$36⁹⁹

KODIAK
\$69⁹⁹

TERRA
\$36⁹⁹

WE HAVE RUBBER BOOTS FOR YOUR JOB,
PLUS WORK GLOVES, COVERALLS, RAIN SUITS, SOCKS,
WE HAVE EVERYTHING YOU NEED

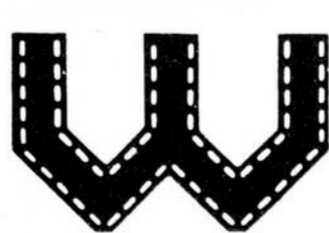

LA OUÉRASSE
IT'S MORE THAN WORK CLOTHES

MON., TUES., WED.,
9:30 a.m. to 6:00 p.m.
THURSDAY & FRIDAY
9:30 a.m. to 9:00 p.m.
SAT., 9:00 a.m. to 5:00 p.m.

CENTRE CARREFOUR
MGR. LANGLOIS,
VALLEYFIELD
TEL.: 371-6461

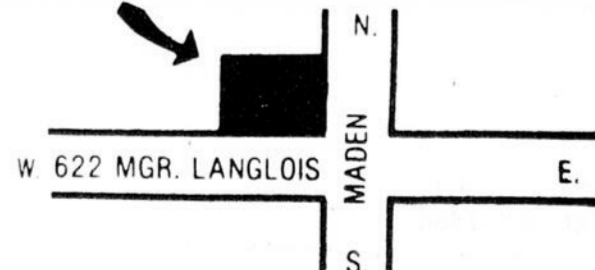

NOW!

RATE OF
10.9%
POSSIBLE ON NEW &

DEMO PONTIAC ACADIANS, 2000, PHOENIX, BUICK SKYHAWKS AND SKYLARKS DELIVERED BEFORE MAY 31, 1982
SEE US FOR REDUCED RATES ON ALL OTHER MODELS

SPECIALS TO CLEAR

1982 PONTIAC PARIS 2D DEMO (LOADED)

1982 PONTIAC 6000 4D DEMO

1982 PONTIAC J2000 4D DEMO

LES AUTOMOBILES RIVERSIDE INC.

LAWRENCE BERGEVIN
HUNTINGDON

AUSTIN MURRAY
TEL: 264-5396

THE HOME OF COMPLETE SERVICE FOR YOUR CAR



GUARANTEED SERVICE
GUARANTEED GM PARTS
GUARANTEED PRICE

BODY & PAINT SHOP
MAN WITH OVER
20 YEARS EXPERIENCE

MECHANICAL REPAIRS
MECHANIC WITH OVER
20 YRS EXPERIENCE

AIR CONDITIONER REPAIRS
WE HAVE THE EQUIPMENT TO REPAIR
YOUR AUTO AIR CONDITIONER

Editorial

OSCAR NIGHT

There was an atmosphere of high seriousness surrounding Monday night's presentation of the Academy awards - quite in contrast to the tinselly splendor so often associated with Hollywood's annual wallow in self-congratulation.

However one views the internal and external hype that surrounds Oscar night, the sometimes blatant campaigns launched by movie studios to promote their products, and the various factors which we are told are considered in selecting winners, the choice of the movie "Gandhi" for eight Oscars, including Best Picture, had an impact on viewers which went far beyond acknowledgement of an example of high-quality entertainment.

The acceptance speech by "Gandhi's" producer, Sir Richard Attenborough, in which he attributed the movie's success to ideas, rather than to entertainment per se, seemed to express the seriousness with which residents of the western world regard the current emphasis on the armaments race as stressed by the American government.

Other "Gandhi" award-winners too stressed the relevance of Mahatma Gandhi's philosophy of brotherhood and passive

resistance in today's nuclear-shadowed world.

The idea that the best films of 1982 were, in the main, socially relevant, was reinforced by the selection of the controversial Canadian film "If You Love This Planet" as best short documentary subject.

"E.T. - the Extraterrestrial", another big winner, dealt with our continuing need for contact with the innocence of the world of childhood, and the hilarious comedy "Tootsie" contains some strong comment on women's rights.

The moving speech by Mickey Rooney, in accepting his special Oscar for his 60 years' work in films, clearly pointed out the ephemeral nature of fame, which comes and goes, while showing the humility and dedication which mark the true professional.

The competent froth dispensed by the hosts and presenters, and the lavish production numbers were typical of Oscar night on TV. They were fun and they will be almost instantly forgotten.

What will remain in our memories are the serious and relevant ideas expressed by people who are tops in their own field, people whose commitment has content as well as form.

J.T.



Letters

School board White Paper arouses fears for future

Recently I listened to a panel of experts express its views of Mr. Laurin's White Paper. One of the panelists, a Liberal MNA, glibly echoed his party's stance on education, and that bothers me.

The various position papers I read, and the newspaper clippings which cross my desk daily, offer the same facile answer to my questions. Many of them favor school boards based on language lines; some want pluralist schools and many approve a moral and sex education program devised by the ministry of education and made compulsory for all pupils. It is also made clear that religious education will be offered only where parents or students ask for it.

Laurin, it seems, is now prepared to offer language divisions, and some universal suffrage for boards. Much of the media will respond in lemming-like fashion to Laurin's proposals, when in fact it is a lot of "sound and fury signifying nothing", and I have a lot of unanswered questions. The real question of confessionality in the schools is still left in suspense and, as a Protestant, I am interested in what we are prepared to give away.

Are we prepared to abandon 150 years of Protestant education, a tradition which fostered and financed a widely recognized system of education? Are we prepared to trade-off constitutional guarantees for language rights legislated by the present government? Are we aware that there are at present well-accepted programs in moral and religious education which are tailored to meet our local needs? Are we so dazzled by promises of structural benefits that we forego our genuine identity as a confessional system?

What will happen to the French schools in a new English board? Will French Protestants be further marginalized? What will happen to administrators and teachers, many of whom lack proficiency in French thus making them ineligible for promotion under Bill 101, and at the mercy of a reorganized structure that will seek out more professionals whose credentials include a "working" knowledge of French? How many will be able to retain?

What will happen to biblical literacy in a secular system? What will happen to religious education, Catholic or Protestant? Are we, in fact, creating a new group of exemptees, many of them Protestants?

That would be especially ironic since Protestants

who built a good part of the system, because they based it on openness and freedom of expression, are now present at their own demise. For many Quebecers the traditional Protestant system fostered and moulded their career opportunities and their spiritual dimensions. In a new pluralist school system, liberated from confessional guarantees, and structured into a language ghetto, and fragmented into numerous little power struggles, will many of our value systems go the way of the dodo?

The Anglican Bishops of Quebec, reminding their members of their responsibilities as parents and Christians said, "confessional guarantees exist not for the purpose of the state or the school board, but rather for the protection and maintenance of the family".

The Protestant committee of the Superior Council of Education had this to say a few years ago:

"Protestant education is the process whereby the Protestant community, recognizing the multi-confessional nature of society, exercises its legal responsibility to provide confessional public education based on the Judeo-Christian culture, in a spirit of free enquiry and respect of differing opinions".

Our present system has allowed a series of means of accommodation among all groups; it has guaranteed a responsible democratic system to meet the needs of its constituents. Laurin is offering us a "mess of pottage" and I am curious to know if he can tell me whether English language boards will last any longer than English language hospitals?

Constance Middleton-Hope, Chairman of the Protestant Committee of the Superior Council of Education, Assistant director-general of the School Council of the Island of Montreal.

Local church choirs combine for cantata

by F.M. Reid

An appreciative audience enjoyed the Cantata "The Wondrous Passion" by W. Curtis and F.W. Peace, presented by representatives from the local United, Presbyterian and Anglican choirs, and guest soloists on Good Friday evening, in St. Andrew's Presbyterian Church, Huntingdon.

The performance was under the direction of Mrs. Mary Dobrik with Mrs. Joanne Lambert at the organ and piano.

Solo parts were sung by Lorraine and Gordon Tannahill, Lynn Harper, Gail Ledderhof, and Pamela Selkirk.

Some of the selections were given by the semi-chorus, along with full choruses by the whole choir. The audience joined in the singing of the three Good Friday hymns.

Afterwards, the Rev. Mr. Livingston invited all present to go downstairs to the church hall for a social gathering.

For the past two years there has been an Easter Sunrise Service held on the banks of the Chateaugay River by the Rev. Allan Lynk and those hardy Huntingdon United Church members venturing out for the 6 a.m. service. This year the weather did not co-operate and so the service was held indoors in the church.

Afterwards, some 45 adults and children enjoyed a pancake, maple syrup and sausage breakfast in the church hall.

Ormsdown

Mrs. Jean McEwen

On Sunday morning, April 10, 1983 at the regular service at St. James' Anglican Church, Canon John Fife conducted the service of Baptism for the infant son of Mr. and Mrs. Norman Hambrook (née Connie Rice) of Montreal. The baby received the names Philip Alden George and his god-parents were Patricia Cantwell of Montreal, Albert Rice of Ormsdown and Bill Rice of Ottawa.

Following the service, Philip's grandparents, Mr. and Mrs. Eric Rice entertained at dinner in his honor. The guests included Canon and Mrs. John Fife,

Other visitors at the same home in the afternoon were Mrs. Elliott White and her daughter Cindy of Lacolle.

Mrs. Mildred Bovay of Dobb's Ferry, N.Y., spent a week at Easter with her mother, Mrs. Margaret Graham.

Births and Deaths

Card of Thanks, In Memoriams, Marriage Notices, Engagements, Announcements

Born

MUMLEY - at Mary Hitchcock Memorial Hospital Hanover, N.H. on March 17 to Stephen and Joanne [née Simpson] a daughter Kate Joanne. Granddaughter to Mr. and Mrs. George Mumley of Alburg, Vt. and Mrs. Dorothy Simpson of Hemmingford, Que.

Died

MUIR, George Ernest - At his residence in Montreal on the evening of April 10, 1983 after a long illness George Ernest Muir, in his 66th year. The second eldest of the six children born to the late Gordon and Jessie [née Greig] Muir of Howick, he is survived by his beloved wife, Edythe [née Hughes] and one son, Robert [married to the former Sigrid Enden]. He will be much missed by his granddaughters, Sarah and Martha. He leaves to

Died

mourn his loss his brothers Oliver [of Pierrefonds, Que.] and Stanley [of Georgetown, Ontario], and his sisters, Marjorie and Myrtle [Mrs. Eric Rumsby] both of Howick. His brother Greig died in 1981. Funeral arrangements have not been announced. "Safe in the Saviour, Washed in His blood; Now in the glory He rests in His love".

Card of Thanks

I wish to express my sincere thanks to Dr. K. Aikin and nurses in the O.R. and to the 2nd floor nurses of the Barrie Memorial Hospital for the excellent care given me while a patient there. Also many thanks to my husband, family and relatives for cards, flowers, visits, and phone calls. All was deeply appreciated.

Mrs. Kenneth Erskine

Card of Thanks

The Ladies Auxiliary of the Hemmingford Medical Centre wish to thank most sincerely all who contributed so generously by donating prizes, refreshments or assistance in setting-up, clearing away and many other ways in order to make the Card Party a success. Your help was greatly appreciated.

I would like to thank Dr. M. Laplante, nurses and staff of Montreal General Hospital, on West 12th floor for the excellent care I received while a patient there. I would also like to thank my son, relatives and friends for all their kindness. Everything was much appreciated.

Gérald O. Hébert

My sincere thanks go to Dr. B.G. Thompson nurses and staff of the Barrie Memorial Hospital for the excellent care given me while a patient there. Deep heartfelt thanks to my family neighbours and friends for the flowers, plants gifts, cards and visits. All was greatly appreciated.

Huguette Sutherland

Ormsdown native gets overseas post

by Jean McEwen

Ross White, son of James White and the late Margaret White (née Todd) of Ormsdown, has received a posting to Europe with the Department of National Defence following a Canada-wide competition.

Ross, who will assume responsibilities as Assistant Director Overseas will be located in Lahr, Germany.

There are 10 schools in Europe affiliated with D.N.D. situated in Germany, Holland and Belgium. These schools serve 3,000 students who are children of Canadians serving with the Armed Forces, and follow the curriculum prescribed by the Province of Ontario.

Ross graduated from Ormsdown High School in 1957 after completing Grade 12. He then attended Macdonald College where he received his teaching Diploma. While teaching he attended Sir George Williams University and received his B.A. in 1963. He then earned his M.E.D. from Bishop's University in 1966 prior to his move to British Columbia in 1977. He was an administrator with South Shore Regional School Board. Currently he is assistant superintendent of Curriculum and instruction of the Nanaimo-Ladysmith District in Nanaimo, B.C.

Accompanying him to Germany will be his wife Pamela and two of their children, Marcia and Randall.

I wish to thank the Drs. and staff of the Barrie Memorial Hospital for their kindness and professional care which I received while a patient for 29 days on 2nd floor. I also wish to express my appreciation to our daughters and several Ormsdown people for their thoughtfulness in conveying my wife to see me, their many cheerful visits, cards and letters; and a special thanks to Rev. M. Carmichael. I am grateful for our fine hospital and our fine citizens.

Allan Mack

I wish to thank Dr. Hebert and Dr. Lemieux, nurses and entire staff of the Huntingdon Hospital for the excellent care I received while I was a patient there. Thank you to the Rev. Samuel and Mrs. Livingstone for their many calls and prayers. Thank you kind neighbours and friends for flowers, fruits, books, candy and your many visits, cards and phone calls. And especially those friends who looked after my house and took me to the hospital. Everything was much appreciated.

Sincerely Grace Gray

Hemmingford

by Joan Kyle

In Hemmingford, on Saturday, April 30 the St. Andrew's United Church Board of Stewards is sponsoring a "Spring Festival" from 10 a.m. to 4 p.m. in the United Church Hall.

This Spring Festival will include a jeans sale, a family photosession, a flea market, a home bake sale, and a quick lunch counter.

The jeans sale will include jeans, cords, and shirts from Levis.

The family photo session has been arranged with a professional photographer who will take photos of families or individuals.

How about a family portrait for Mother's Day or Father's Day? Perhaps grandparents would like to surprise their families with a delightful portrait.

Huntingdon Hospital Foundation

The Huntingdon County Hospital Foundation wishes to acknowledge with thanks the following donations:

Memberships: Mrs. Dorothy Hawley; D.L. Davidson.

In memory of Mrs. Bertha Brown: \$20 from Caldwell Scrivner.

In memory of Walter Sutherland: \$10 from Mr. and Mrs. Joseph Neuenhof.

In memory of Gerald Smith: \$50 from George Kennedy.

In memory of Lucien Galipeau: \$20 from Mrs. May Duke and Miss Betty Mose.

In memory of Mrs. Violet Winter: \$10 from Mrs. Grace Fleming; \$10 from Mr. and Mrs. George Williams.

The flea market will offer many good items for sale. If anyone in the community would like to donate any articles for the flea market, they may leave them at George and Mary Aboud's place at 456 Frontier St. Arrangements can be made to have items picked up by calling the Abouds at 247-2954; Florence Bourdon at 247-3306; or Joan Kyle at 247-2438.

The home bake sale table will offer many items from pies to muffins to cakes etc. Come and buy and fill your freezer for those busy spring days!

Light lunch will also be available.

Come and have your portrait taken, browse through the flea market, and jeans tables and have your lunch.

For further information concerning the Spring Festival in Hemmingford's United Church Hall, you may contact George Aboud, Florence Bourdon or Joan Kyle.

Watch for ads concerning our Spring Festival in this newspaper.

The family of the late Wayne Ferns wish to thank all relatives, friends and neighbours for their many acts of kindness and thoughtfulness at the time of our loss of a husband and father. Everything was very much appreciated.

All our thanks

Thelma, Lorrie and Donny

Many thanks to Dr. George Lefebvre, the nurses and staff of the Huntingdon County Hospital, for their kindness and care during my stay there. To my relatives, neighbors and friends, my deep appreciation for their cards, gifts, visits and especially their many kindnesses to my wife. All was very much appreciated.

Hector Miner

Advertising

IN THE GLEANER saves you time!

KELLY

Funeral Home
Reg'd
GORDON McINTYRE
Proprietor
FUNERAL DIRECTOR
PHONES:
264-547, 264-5002
HUNTINGDON, QUE.

MONTPETIT

Funeral Home
RODRIGUE MONTPETIT,
Proprietor
FUNERAL DIRECTOR
MODERN PARLORS
Cremation
PRE ARRANGEMENTS
170 CHATEAUGAY ST.
HUNTINGDON
TEL. 264-5021
Summer Res. 371-0499

Our new toll free! number...
1-800-363-1446
Little Dream
Flower Shop
HEMINGFORD, QUE.
TEL. 247-2718 (Local)

THE GLEANER
THE LEADING ADVERTISING MEDIUM IN THE CHATEAUGAY VALLEY

ROGER H. DAoust
PRESIDENT

JUDY TAYLOR
EDITOR

SECOND CLASS MAIL
REGISTRATION NO. 0733
U.S. REG. NO. USPS 580 300

SECOND CLASS POSTAGE
PAID AT CHATEAUGAY,
NEW YORK, 12920

PUBLISHED BY
THE HUNTINGDON GLEANER INC.,
P.O. BOX 130, HUNTINGDON, QUEBEC, J0S 1H0

SUBSCRIPTION RATES
CANADA \$16.50 yearly
UNITED STATES \$19.50 YEARLY
Single Copy 40 cents

CNA

Printed in Canada

Call to Worship

by members of
the Chateauguy Valley
Ministerial Association

How the Churches Go Astray: A Rebuttal

In a recent issue, *Maclean's Magazine* ran an article entitled, 'How the Churches go Astray' by Barbara Amiel.

In the article, Ms. Amiel lambasted the church for its failure of late to promote the beliefs and values upon which our western liberal democracy is built.

Further, the article was written so as to have us believe that the church is being infiltrated by left-wing radical groups which are intent upon using it to promote communist ideology. And then taking a posture of judgement, Ms. Amiel goes on to denounce the church's deviation from western norms as heretical to the gospel.

I would like to point out two gross errors in Ms. Amiel's analysis.

1. The first is her assumption that Christianity is synonymous with western liberal democracy, which it is not, and:

2. The second is her assumption that the church's cry for social justice originates in the doctrines of Marx, which it does not.

Take a minute now to reflect upon some of the western beliefs and values which Ms. Amiel asks the church to capitulate to. Are they not the same ones which permit so many millions of people to live without the dignity and right to work? Are they not the same values and beliefs which have left our society in a state of obsessed consumerism? Is it not the values and beliefs of western liberal democracy which allowed the potential breakdown of our ecology through such things as acid rain? Isn't it the ideology of the west which has played a major part in that insanity called "the arms race"? And isn't it our government's foreign policy which is in a large way responsible for global hunger in a bounteous world?

How then, can the church, if it is to be faithful to Christ, acquiesce so completely, as people like Ms. Amiel would have it, to

such a system of values and beliefs? No, the followers of Christ cannot. It has been the mandate of the church to struggle for justice since its dawning.

That struggle is documented in nothing less than the word of God - the Bible. We read of it in the account of Israel's exodus from slavery in Egypt. It was recorded in the words of the prophets who challenged, and sometimes condemned, the authorities of their day for disobedience to God, corruption, and lack of concern for the welfare of the poor, the widows and the orphans. And it is dramatized in the life of Jesus, who sacrificed his life for the outcast, the downtrodden and the rejected.

It was Christ himself who started his ministry with an inauguration speech that went something like "...the spirit of the Lord has chosen me to preach the good news to the poor - to proclaim liberty to the captives - to set free the oppressed".

To abandon the church's struggle for justice for a blind unquestioning and uncritical patriotism would be to abandon something which is at the very heart of the church's purpose and mission in the world.

People who seek to muzzle the church on issues of political, economical and environmental concern reveal a definite shallowness of insight into the church's history and nature. Ms. Amiel would do better to write as an atheist defending totalitarianism than under the pretense of being a Christian defending democracy.

The church would be in error if it abandons its values and beliefs for Marx. But it would be equally so if done for the likes of Adam Smith. The values and beliefs it is to promote are those of Christ above all else.

So, from what has the church gone astray? In this instance certainly not from God, for the church belongs neither to the west, nor the east - but to Christ.

Rev. James Lee Hemmingford Pastoral Charge
The United Church of Canada

* Amiel Article: How Churches Go Astray, [Maclean's News Magazine, February 14, 1983 p. 13].



The referee signals the first Huntingdon goal in last week's girls' hockey encounter. (See story Page 8)

Photo: Bob Stone

Police briefs

SHOT IN BACK

A 67-year-old St-Chrysostome man was injured when he was shot in the back during an argument with his wife on Tuesday, March 29.

The incident occurred about 8 a.m. at the couple's Rte. 203 home. The victim was Sarto Gervais, whose wife Emma shot at him with a 22 calibre revolver. Gervais was taken to the Barrie Memorial Hospital in Ormstown where he underwent surgery to remove the bullet. The wound was not serious.

St-Martine provincial police were called to the scene of the shooting and were joined by personnel from the Montreal-based QPP special squad for crimes against the person. Gervais is said to be recovering well from his injury.

MINOR INJURIES

A motorcyclist received minor injuries when he lost control of his vehicle on a curve on the Rang Deux near Ste-Clothilde on Saturday, April 9.

Jean-Jacques Poupart of Longueuil was treated at Ormstown's Barrie Memorial Hospital following the 3:15 a.m. accident, which occurred near the Rte. 205 intersection. Ste-Martine Provincial Police reported.

HOWICK ACCIDENT

Raoul Bourdeau of St-Chrysostome was treated for minor injuries following a single-car accident on Rte. 203 near the Bridge St. intersection outside Howick on April 8.

The accident, resulting from a loss of control, occurred about 6:45 p.m. Bourdeau received first-aid treatment at Ormstown's Barrie Memorial Hospital.

COLLISION

A two-car collision was reported shortly after 8 p.m. April 8 in Ste-Martine.

The accident took place at the intersection of Rte. 138 and Station St. in the Hotel Jeanneau parking lot. One car was attempting

to turn into the parking lot at the time.

Drivers involved were Sylvie Huneault of Beauharnois and Isabel Sutton of Franklin Centre. Mrs. Sutton's car received minor damages in the collision.

CARS DAMAGED

Three cars parked at Ormstown's Centre d'Accueil during the evening of March 30 were damaged, seemingly by someone using a pointed implement.

The incident occurred between 8 and 11 p.m. The vehicles involved were owned by Claude Primeau of Ormstown, Jeannette Laniel of St-Anicet, and Anne-Marie Bourdeau of

St-Antoine-Abbe.

Agent Michel Hébert of the Ste-Martine QPP detachment is in charge of the investigation. Each of the cars received damages estimated at \$500.

ORMSTOWN ACCIDENT

A two-car collision was reported on the evening of April 4, at the intersection of Church and Gale Sts. in Ormstown.

Drivers involved in the 9:45 p.m. crash were Michelle Charlebois of Montreal, and René Leboeuf of Valleyfield. Damages to the cars was estimated at over \$500 each, according to Ste-Martine QPP agent Yvon Leroux, who was called to the scene.

ONE INJURED

A collision on Rte. 203 at St-Chrysostome on March 29 resulted in minor in-

Delay... from page 1

truck labels) must be French-only.

• Communications with

all Quebec companies and institutions must be in French (such things as property and business tax receipts);

• Public notices must be in French only;

• "Exit" signs in all municipal buildings must be replaced with "Sortie";

• French instructions must be added to chemical fire extinguishers;

• Municipal pay check forms, including detachable sections, must be in French only;

• French only, along with symbols or pictograms, must be used for highway and road signs; and any

English descriptions such as "St.", "Rd." etc. must be removed in favor of French only.

As well, the Town has been asked to send in a

copy of an agreement signed by the municipality and the OLF, stating that all new or transferred municipal employees must have an "appropriate understanding" of French.

Ormstown

Mrs. David Kee, Vanessa and Christina of Toronto, Ont.; Kimberly Hooker of Fiesherston, Ont.; Mrs. Garth Coffin and Tricia of Pierrefonds, Que. visited last week with Mr. and Mrs. Alan Hooker.

Mrs. J.W. Gartshore of St. Bruno and her son Geoffrey of Toronto were guests recently at Mrs. Harold Parkinson's.

JEAN-GUY R. PROULX, C.A., M.Sc.C.
COMPTABLE AGRÉE / CHARTERED ACCOUNTANT

1436 RG BOUTREUX
ORMSTOWN QUE
JOS 1K0
TEL (514) 829-3403

CASE POSTALE 262
LONGUEUIL QUE
J4K 4Y3
TEL (514) 677-2644

The Lasso® -atrazine mix means a superior control of grass weeds while increasing corn yields.

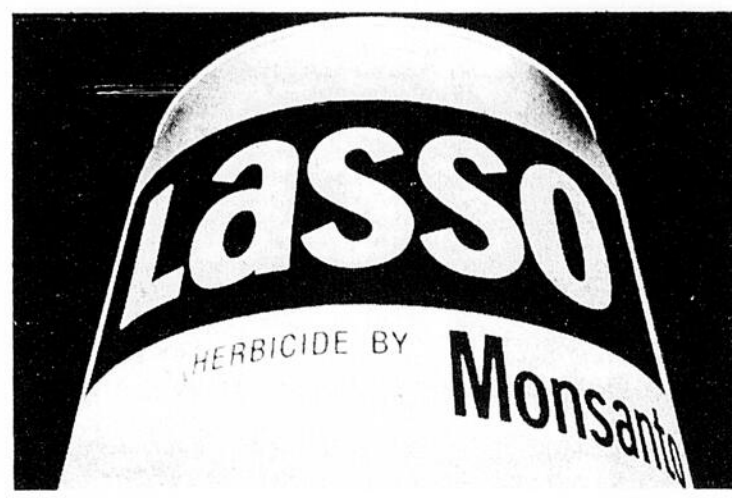

The unbeatable choice against grass weeds.

ALWAYS READ AND FOLLOW INSTRUCTIONS ON THE LABEL. LASSO IS A REGISTERED TRADE MARK OF MONSANTO MONSANTO CANADA INC., AUTHORIZED USER © MONSANTO COMPANY, 1982 MONSANTO CANADA INC. WINNIPEG, MONTREAL, TORONTO, REGINA, SASKATOON, CALGARY

DEALER:

**DUSSAULT
AGRI-SERVICES INC.**
59, MONTEE DU LAC
STE-BARBE
TEL. (514) 373-4625



Howick

It was good to see some of our Florida wintering folk back in town again - Rev. John and Myrtle Anderson were given a warm welcome by old Howick friends even if the weather declined to share the welcoming warmth.

NEW AND USED CAR SAVINGS

82 OLDSMOBILE CIERA

Brougham Demonstrator

Retail Price 14,268.90

NOW ONLY \$11,500.00

USED CARS

81 PONTIAC, 4 DOOR
80 PONTIAC, STATION
79 IMPALA, 2 DR.
79 OMEGA, 2 DR.
78 THUNDERBIRD, 2 DR.
77 IMPALA, 2 DR.
77 DODGE
76 FIREBIRD
73 CHEVELLE STATION

10.9% G.M.A.C. FINANCING

on new
Chevettes - Cavaliers
Citations - Firenzas - Omegas

HUNTINGDON MOTORS INC.

Jimmy Smythe

TEL: 264-6163 HUNTINGDON

THIS IS WHERE THE ACTION IS!

Boutin Moteur Inc.

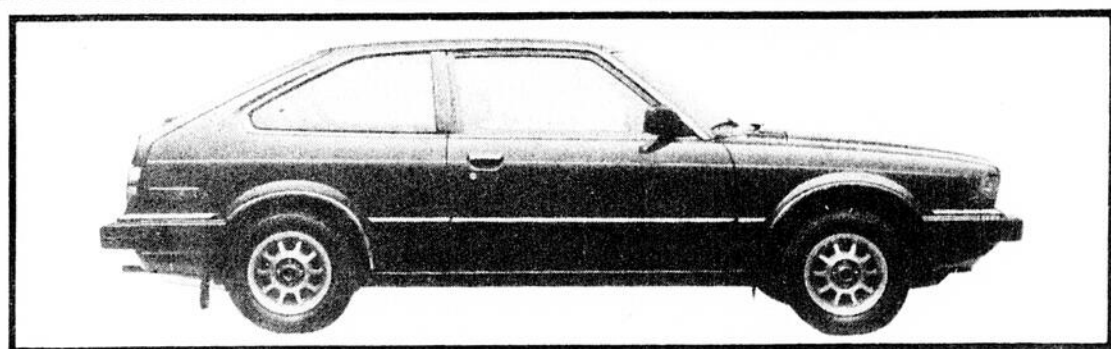

1983 HONDA ACCORD

STATED TO BE "THE MOST BEAUTIFUL REALIZATION IN THE COMPACT CAR CATEGORY" BY THE MAGAZINE "CAR AND DRIVER", THE 1983 HONDA ACCORD AGAIN PROVES ITS SUPERIORITY BY THE EXCEPTIONAL QUALITY OF ITS FINISH AND BY MODEST THOUGH PRECIOUS IMPROVEMENTS.

"The best-managed automobile company in the world. Honda builds only success cars"... "Motor Trend" Magazine.

"The Honda Accord is by far the best compact car. Its motor runs perfectly and its drive is soft and silent enough to satisfy the most demanding amateurs who like high-class cars". "Car and Driver".

"More spacious and comfortable, always a pleasure to drive and with a reliable mechanical equipment, the Honda Accord more than ever represents one of the best values on the market". Jacques Duval, Auto Guide.

In the course of the seven years since it came out, the Accord has received many international prizes as well as the almost unanimous praises of automobile critics. Not all cars can achieve such a reputation. But the Honda Accord is not a car like the others.

And for good reasons: The Accord is the perfect match of comfort and luxury usually found in much costlier cars, with the mechanical reliability and gas savings which are the trademark of Hondas. In short, the Accord is a car which is most agreeable to drive.



WE'RE WORKING FOR YOU

POSSIBILITY OF 11.75%
A 36 MONTH LOAN

HONDA

Boutin Moteur Inc.

478 Boul. Mgr. Langlois,
Valleyfield

373-2924 373-2483

Transport and store easily

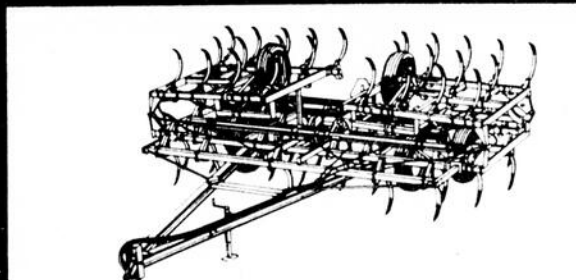

Wide-working John Deere field cultivators fold up and over for easy transport, easy storage

Glide through snug gates — breeze under low powerlines. Then when you get to the field, your field cultivator unfolds for fast work.

Models 15½ to 30½ feet fold flat, wider models fold vertically.



371-9220

CANISO

CENTRE AGRICOLE SUD-OUEST INC

415, RTE 132,
STE. BARBE, P. QUE.

NEW 140-HP 4450



Measure its efficiency at the fuel pump, on your wristwatch or in your crop cost ledger

No matter how you measure it, the 140 hp 4450 represents powerful new efficiency for your farm.

The 466-CID turbocharged John Deere diesel has been redesigned to improve fuel efficiency. And new 15-speed Power Shift transmission lets you match that fuel-efficient power precisely to your job. You can save time in any job when you never have to stop to shift.

Caster/Action™ mechanical front-wheel drive saves you time and fuel by increasing traction. Stop in for more details on the field-efficient 4450.



Save \$500-\$600
Quality economical paint

899
Our Reg \$13.99
4 litres

EASY FLOW interior latex dries in less than one hour to a beautiful satin finish. Durable high coverage for almost any room - almost any surface. In white only, at this sale price. 48-3841

Exterior acrylic latex **1099**
Dries fast to a satin finish. For houses, garages. In white only for this sale 48-4741 Reg \$16.99 4 litres

CANADIAN TIRE
Annual Value Guide
1983-84
Wrapper Offers

It's here! Your all-new, 12-month guide to shopping at Canadian Tire. Huge selection of merchandise at our dependable everyday low prices. All wrapper offers expire Saturday, April 23 1983



Save \$100
Camp chair comfort

599
Our Reg \$6.99

Lightweight tubular steel frame sets up in a snap, folds flat for compact storage. Assorted prints. 88-0146



There's a lot more to Canadian Tire than tires

Double Saving

40% TO 46% OFF ALL MOTOMASTER OIL FILTERS

Built to exact standards. Meet original-equipment quality. For most popular domestic and foreign applications. 17-1704X
199
to \$4.59
Regular \$3.49 to \$7.99 each...

Save an additional \$1.00 with a MOTOMASTER REBATE

Stamp and mail your in-store coupon to get a \$1.00 rebate by mail (allow 6 weeks for return). Only one rebate dollar (\$1.00) per customer.

You could pay only... **99¢** to \$3.59

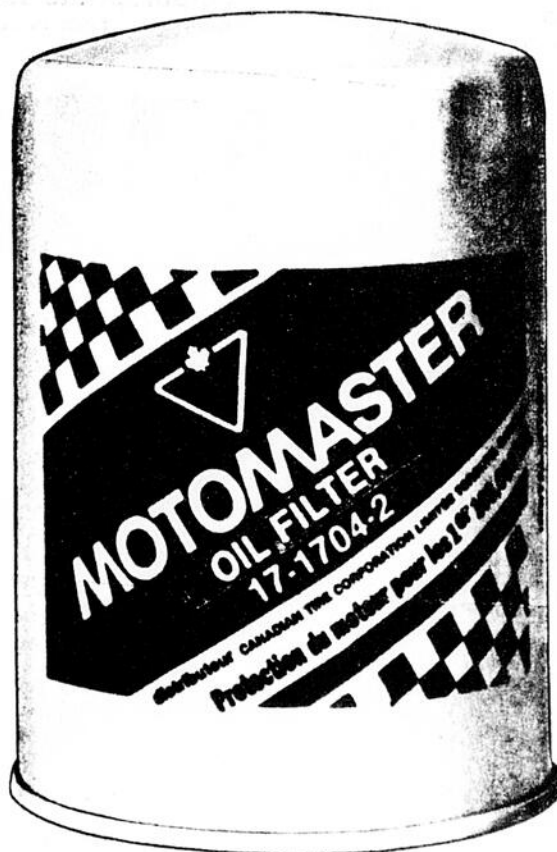

Save 70¢
10W30 MULTIGRADE OIL

99¢ litre

Reg \$1.69. Imparts a tough film to lubricate moving parts in modern engines. Meets API Service Classification SF-CC. 28-7313

All wrapper offers expire April 23 1983. No mail orders, please

We reserve the right to limit quantities subject to stock availability



Pollenex
Air cleaner/deodorizer

Special Purchase 1299
With activated charcoal filter

Pollenex Pure Air 99 removes smoke, pollen, dust, odors, etc. For home or office. 99-5290

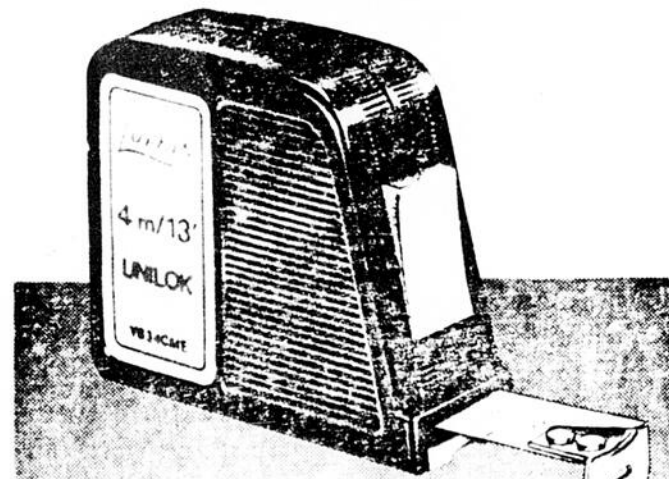

Lufkin tape measure

Special Purchase 399
Blade-lock mechanism

High quality 4m/13' X 3/4" steel blade housed in tough plastic. Steel belt clip. 99-5040



Non-stick fry pan

1199
Reg \$20.99

Wear-Ever aluminum skillet has hard-wearing SilverStone cooking surface that makes cleaning up a breeze and allows you to cook with little or no oil. 25-cm diameter. 42-0480

Save \$9.00



ARMAND ST-JACQUES INC.

CARREFOUR MGR. LANGLOIS

560 BOUL. MGR. LANGLOIS • TEL.: 371-2470 • VALLEYFIELD



Quota... from page 1

Chateauguay Valley English speaking producers' group. Many producers have expressed worry at the amount of dairy quota bought up by dairy operators from other parts of Quebec. Figures for 1982 show that 4.8 per cent of all milk quota in the St-Jean-Valleyfield region was sold to outsiders. Of the quota offered for sale last year, 60.3 per cent of the fluid quota left the area. The figures for transformation (industrial or Class II) milk indicate that 59 per cent of the used

quota and 51.3 per cent of the unused quota went to outside buyers. "In 1982, as much as 79 per cent of quota sold in a given month has gone outside our area," said Bryson. **Export quota:** Faced with indications that the government is looking for areas to cut Class II (industrial) quota, producers at the Ste-Martine meeting passed a resolution formulated from recommendations from various local groups, including the Chateauguay Valley, asking that the five

per cent Export Quota, added a few years ago, be maintained. Many producers feel that the situation could be improved by cutting down on the 45,000,000 pounds of cheese imported into this country annually from abroad. With statistics showing a two per cent increase in butter consumption for the months of December, January, and February, producers were encouraged enough to recommend an increase from 47 to 50 cents per hectolitre in the holdback for advertising deducted from industrial milk cheques. These three resolutions will be carried to the provincial milk producers' meeting scheduled for April 19 and 20 in Montreal. Two other resolutions brought to the regional level from the Chateauguay Valley group met with a less enthusiastic reception. The suggestion to set up a quota exchange in place of the monthly quota auctions more or less died on the floor. "But I think we'll be hearing more about it in the future as I heard several favorable comments from some people

who seemed quite impressed and just want a little more time to get used to the idea," Bill Bryson told The Gleaner following the meeting. A second CV resolution, calling for Class II quota to be measured in litres, rather than by butterfat was tabled for further study. Roger Daoust of St-Etienne was elected president of the new joint regional group. He is a former president of the industrial producers' association, and succeeds Réjean Grégoire of Napierville, who has served as president of the fluid producers' group since 1978. Réal St-Onge of St-Anicet was named vice-president, and Gabriel Bourdeau of St-Chrysostome will represent the district presidents on the executive committee. The board of directors will include the nine district presidents: M. Bachand of Verchères, Bill Bryson of Chateauguay Valley; Réal St-Onge of Huntingdon; Roger Daoust of Beauharnois; Guy Vincent of Vaudreuil-Soulanges; Gabriel Bourdeau of Chateauguay

District; Bernard Besner (Ontario); Réjean Grégoire (Napierville); and François Simon of St-Paul-Ille-aux-Noix. A total of 14 delegates from the St-Jean-Valleyfield region will attend the provincial meeting of the Fédération de producteurs de lait du Québec next week. Among the voting delegates is Bill Bryson, while Wayne Jackson of St-Anicet was named as a substitute. As far as the Ste-Martine meeting is concerned, Bryson said he was extremely pleased to see so many representatives of the Chateauguay Valley group present. "Ten of our 11 directors were there, as well as some other members - our area was really well-represented," he said.

Bus... from page 1

Abbé. Discussions are under way with the Franklin Fire Department on the purchase of a resuscitator, at a price of about \$800, and about sponsoring courses for firemen on its use and on other aspects of firefighting, at a cost of about \$50 per fireman. The Department of Transport will be asked to pave the Franklin portion of Rte. 202 during the current year. It was resolved that, once the period of Interim Control on the issuing of building permits is over within the MRC, all building permits must be approved by council as well as the municipal building inspector. Given that the Interim Control by-law has put a

temporary halt to new construction in MRC territory, Franklin supports an MRC resolution asking the federal government to extend its aid program for new construction beyond the April 30 deadline, as many people are losing out on the \$2,000 grants because of the building permit freeze. Council accepted the new rates set by the Department of Municipal Affairs for providing copies of "certificates and documents." Franklin will ask the MRC to help exert pressure on the Quebec Department of Agriculture to finish drainage work on the Rivière Noire, a project which was begun in 1978. Bills totalling \$22,551 were passed.

temporary halt to new construction in MRC territory, Franklin supports an MRC resolution asking the federal government to extend its aid program for new construction beyond the April 30 deadline, as many people are losing out on the \$2,000 grants because of the building permit freeze. Council accepted the new rates set by the Department of Municipal Affairs for providing copies of "certificates and documents." Franklin will ask the MRC to help exert pressure on the Quebec Department of Agriculture to finish drainage work on the Rivière Noire, a project which was begun in 1978. Bills totalling \$22,551 were passed.

temporary halt to new construction in MRC territory, Franklin supports an MRC resolution asking the federal government to extend its aid program for new construction beyond the April 30 deadline, as many people are losing out on the \$2,000 grants because of the building permit freeze. Council accepted the new rates set by the Department of Municipal Affairs for providing copies of "certificates and documents." Franklin will ask the MRC to help exert pressure on the Quebec Department of Agriculture to finish drainage work on the Rivière Noire, a project which was begun in 1978. Bills totalling \$22,551 were passed.

Saracens start season with jaunt to Albany, N.Y.

Ormstown Saracens rugby club started its 12th season with a long trip to Albany N.Y. last Saturday to play Albany Knicks, the top-rated team in Upstate New York. Because of college and work commitments Saracens took a weak team and paid the price. Starting slowly, Saracens were behind 13-0 at the half but came on strong in the second half and outscored Albany 6 points to 4, to lose 17 points to 6. This was an encouraging start to the season with several young players showing much promise. Top performers, however, were veterans Bernie Bonenberg, Dave

Thompson, and Guy Lavallee in the forwards, and Ian Cole in the backs. Saracens' touchdown was scored by the fast improving Serge Tremblay after a 60 metre run, and Hugh Maynard had the convert. Randy Côté, playing his first game, looked like a good prospect for the future. Several Saracens reserves played a game for Albany's "B" squad and young Billy Lucas showed fine form by scoring two touchdowns and assisting in another. All agreed it was a fine way to start the season and with good turn outs at practices, Saracens are hoping for another good season.

Gleaner ads work wonders

HOUSE OF COMMONS

PARLIAMENTARY TASK FORCE ON PENSION REFORM

The House of Commons Task Force on Pension Reform will be holding meetings to consider the proposals for reform of the Canadian retirement income system contained in the Government of Canada's paper "Better Pensions for Canadians", with special reference to the following:

1. the method of inflation protection proposed for employer-sponsored pension plans;
2. the changes proposed in survivor benefits under the Canada and Quebec pension plans;
3. the issue of expanding mandatory pension arrangements;
4. the financing of the Canada Pension Plan;
5. the proposals to overcome the special problems facing women, including homemakers, under the current pension system.

Individuals and organizations wishing to make written submissions to the Committee relating to the subject of pension reform may do so in French, English, or both official languages. If possible, submissions should be typed on 28cm by 22cm paper, with margins of 3cm by 2cm.

Those appearing before the Committee will be selected from among those who submit a written brief or who make known to the Clerk of the Committee their intention to send a brief before 5:00 o'clock p.m., on June 30, 1983.

Submissions, correspondence and inquiries should be addressed to:

Audrey O'Brien
Clerk
Parliamentary Task Force
on Pension Reform
House of Commons
Ottawa (Ontario)
K1A 0A6
Tel. (613) 992-3150 ext. 231
DOUGLAS C. FRITH, M.P.
CHAIRMAN

Gordon Harrison

OPTICIEN

When in St. Lambert, plan to visit our Optical store for the most courteous professional eye care service. 465-3058
592 A Victoria Avenue

And for quality and service of another kind...

Franklin Studio
Craft supply shop
Signs & Lettering
Printing & Copies
Art & Craft class

827-2392 Daily 10-4 Sat. 10-11
1283 Route 202, Franklin Centre

The goddess of long-distance hikes

If you wish to reach far-away horizons, you must think of the touring motorcycle which answers all your needs: the Suzuki GS 1100GK. Its powerful motor allows for fantastic gas savings. Its easy handling is recognized by experts as being the best in its class. Thanks to its softest of suspensions and driving-shaft, you ride in total comfort. And the streamlined body with ventilated base, the easily-detachable travel chest, the bags and touring seat make the difference between "going in style" and just "going".

The Suzuki GS 1100GK
When you want to go far

**GS 1100GK
COMPETITIVE PRICES**

F & G LEPAGE INC.

ORMSTOWN 829-3044



ADVERTISING FEATURE

**DUAL-ENERGY HEATING:
AN UPDATE FROM HYDRO-QUÉBEC**

Only introduced in October 1982, the Installation Grant Program for Dual-Energy Heating in Single-Family Homes can already be hailed as an outstanding success. In these few short months, Hydro-Québec has received over 20,000 requests for grants and, as at the beginning of March, it was estimated that 10,000 dual-heating systems had already been installed. It should be remembered that, while the Program is available until December 31, 1984, Hydro-Québec reserves the right to accept only the first 100,000 requests received.

ELIGIBILITY

The Program combines two possible grants: one from Hydro-Québec, which is for up to \$650, tax-free, available from now until the end of 1983 (more on this later) and one from the Canada Oil Substitution Program, which is taxable and covers 50% of conversion costs up to a maximum of \$800. Certain conditions must be met to qualify for the Hydro-Québec grant and these are detailed briefly below:

1. For the time being, only single-family homes are eligible.
2. The present main heating system must depend on an energy source other than electricity, with the exception of natural gas.
3. The present system must be converted to dual-energy heating by the addition of an electrical heating system: electrical elements installed in the hot-air chamber, forced-air heat generator, heat pump, base-board heaters, etc.
4. The present heating system must be able to provide another five years' satisfactory operation. In some cases, this will have to be checked and certified by a master plumber.
5. One of the dual-heating systems will be automatically started by means of a sealed, outdoor thermostat or, alternatively, by a thermostat connected to an outdoor sensor, also sealed, so that the temperature setting cannot be changed. The temperature setting (-12° or -15° C) depends on the climatic zone in which the

house is located. In most cases, installation of a dual-energy heating system will not require replacement of the main electrical entrance, but customers should always check that its capacity is suitable for proper operation of the electrical heating system when the outside temperature drops to the level for which their thermostat is set. Hydro-Québec recommends that customers consult a master electrician about this and, if work is required, that they ask to see his permit from the Québec department responsible for the inspection of electrical installations. If a new entrance is required, it would be advisable to ensure that it can supply all the home-heating requirements.

DATES TO REMEMBER

1. In order to receive the maximum grant of \$650, the dual-energy heating system must be installed between October 8, 1982 and December 31, 1983. A fixed amount of \$500 will be payable for systems installed during 1984.
2. Appropriate request forms must be received by Hydro-Québec before April 1, 1984 for the maximum grant of \$650 and by April 1, 1985 for the fixed sum of \$500.

Hydro-Québec DOES NOT INSTALL DUAL-ENERGY HEATING SYSTEMS

It should perhaps be pointed out here that Hydro-Québec makes the Dual-Energy Heating Grant Program available and administers it, but has nothing to do with the supervision or installation of the heating system. Under Quebec law, the only people who may carry out this kind of work are the members of the Corporation of Master Electricians. Furthermore, Hydro-Québec has signed no agreement with any firm whatsoever in connection with dual-energy system installation nor given them authority to undertake work of this nature. We therefore recommend that customers contact the various professional corporations for information if need be, since they regulate their members' activities.

FURTHER PRECAUTIONS

We also feel it may be worthwhile quoting extracts from a press release issued by the Consumer Protection Office on February 10, which highlights some important points applicable in the present circumstances. "Merchants soliciting consumers in connection with the Installation Grant Program for Dual-Energy Heating in Single-Family Homes administered by Hydro-Québec are subject to the provisions of the Consumer Protection Act and, especially, to those covering itinerant merchants or door-to-door salesmen. Specifically, such people must possess the Itinerant Merchant Permit required under the Act and any contract concluded must be in accordance with the Act." "It should be pointed out that the permit, while not guaranteeing the quality of the services provided by the merchant, does indicate that the latter has deposited a bond as surety that the requirements of the Consumer Protection Act will be observed. In their own interests, consumers taking advantage of the Hydro-Québec program should check that the merchant with whom they are considering doing business does, in fact, hold an Itinerant Merchant Permit. It should also be remembered that a contract with an itinerant merchant may be cancelled within 10 days of the day on which the consumer received a signed copy of the contract." Finally, customers should always ensure that electrical appliances installed in their homes bear the Canadian Standards Association (CSA) seal.

A REMINDER FROM HYDRO-QUEBEC:

- All electrical installation work must be carried out by a master electrician.
- Electrical appliances and systems must carry the CSA seal.
- Itinerant merchants and door-to-door salesmen offering to install dual-energy heating systems must comply with the Consumer Protection Act.

DUAL ENERGY



SPARTAN TALK

C.V.R. SPORTS

by STEPHANIE ADAM



Bye bye volleyball and basketball and hello track and field.

Yes, it's that time of year once more, when indoor sports in high schools are "put on the rack" until next fall, and when our thoughts concentrate on the outdoor sports of track and field.

CVR is winding up for the upcoming track season, in which up to six meets are planned. It is possible that some meets will be held during the summer.

Practices, which essentially started two weeks ago, are being held twice a week and approximately 80 to 100 participants are attending.

The track and field events with their coaches include: throwing events (Mr. Dhani); sprinting events (Mr. Petersen); long and triple jumping (Mr. Doherty); long distance running (Mr. Hutchings); Coaching hurdling, pole vaulting and high jumping is Mr. Woods.

Many of the older, more experienced athletes such as Jamie Mang, Ronna Reddick, Robert McNamara, Heather Milne, Randy Maitner, Nancy Stacy and so on have graduated. This leaves our team with more rookies than experienced members. However with the

talent that seems to be appearing in the younger age groups and with the developed talents of the older members, we should have a strong track team nonetheless.

Last year the track team composed of 129 members placed third overall out of 11 South Shore schools and won two team championships, Class 1 Girls and Class 7 Boys. Also, last year we set seven south shore records.

Some of the record setters are back this year. We are hoping to at least make second place this year and to win three or four team championships. The number of members is anticipated to be between 100 and 110 and we look forward to perhaps setting the same number of records.

Our boys' team is a strong one this season, but the girls team is fairly weak due to a lack of numbers in the senior girls level. Since our school is quite small, it is difficult to compete with the larger schools, but we look forward to a very exciting and competitive season.

If there are any other students wishing to try out for the team, this week is the time to do it. There might be a sport that is right for you.

Girls notch up a win in final game of year

by Roland Greenbank
A dedicated group of players wrote "finis" to the 82-83 hockey season on Sunday in Nepean's Bell Arena as Goal Diggers II shaded the N.G.H.A.'s Hubert Heating club by a 2-1 count.

It was the line of Lori Smythe and Nathalie Hatch, with the addition of France Pilon on right wing which provided the scoring punch. The trio combined for both Huntingdon goals, the first coming in the first minute of play on very slow ice which proved to be a hazard for Sandy Reid in the Nepean nets. Hatch flipped the puck home after her two linemates had set up the play.

With 4:24 remaining in period 1, Sharon Craig broke out over her own blue line and, with the defense caught up-ice, beat Barbara MacDonald cleanly to tie the score.

This was the day's only serious defensive lapse for Goal Diggers. The checking line of Ann Hackett, Manon Leblanc, and Trudy McWhinnie kept Nepean off the score

sheet during their tours of duty, while Barbara MacDonald played a super game behind the defense composed of Marcia O'Connor, Cheryl Barrington and Ruth Greenbank.

France Pilon jammed in the winning marker as the seconds ticked down in the first period, with Smythe and Hatch drawing the assists. The win made it three straight for Goal Diggers II over the Nepean club this season.

On the National Championship front in Taylor, Mich the Massena Chicks were knocked out in the semi-final round, dropping their contest against Stoneham, Mass by a count of 4-2.

Again in Michigan, the flashy Massena boys midget team, the Red Raiders, were stopped by East Providence 6-2 and Detroit Compuware 11-2 to eliminate them from further contention. The Red Raiders appeared in Huntingdon earlier this year, winning a series against the local midgets.



The Howick-Ste-Martine Pee Wee hockey team which topped the Beauval Inter-City League this season:

front [left to right]: Eric Brault, Benoit Briere, Sté-

phane Longtin, Michel Doyon, Pascal Brault, Alain Pelletier; back: François Faubert, Dale Ness, Michel Inkel, Martin Amyot, Benoit Dubuc, Dominique Myre, Denis Thibeault, Luc Charron; manager: Leo Brault;

coaches: Michel Lazure, André Lepage.

Ste-Martine Pee Wees victors in Inter-city hockey playoff

by Evelyn Lamb
All winter long, parents and players have kept some strange schedules in order to be present at those all important hockey games taking place out of the Ste-Martine Arena.

For one Pee Wee team, at least, all the effort paid off. They topped the

Beauval InterCity Pee Wee Hockey League and came out as the champions after a best-of-five series with Huntingdon.

At the end of the regular season's play they finished one point behind Valleyfield, but went on in the play-offs to defeat Beauharnois in the semi-

finals and then Huntingdon in the finals.

The boys on the team are 11 and 12 years old from the Howick-Ste-Martine area. Of this group of 14 players, eight are first year so the promise of a good season next year beckons brightly. The boys had plenty of experience on the ice.

They had regular practice and games as well as three tournaments played in Ville La Salle, Longueuil and Beauharnois.

They deserve congratulations as do the parents and coaches who devote so much time to the game of hockey and the training of the boys.

Minor Hockey season ends with house league tourney

by Hank Cross

Huntingdon Minor Hockey wound up its 1982-83 house league season on Good Friday, with play-off championships and consolation awards in the various age divisions.

After the Novice play finished, the finals were held in the Atom division. Atom champs were the Red (Moose) team, which defeated the Rainbow Jeans entry 3-2 in an overtime showdown. A total of 27 shots were taken before the all-important goal was scored. Coaches of the winning

team are André and Paulette Pivin, and the Red goals were notched by Martin Anderson, Eric Latreille, and Martin Legault. André Roy scored both goals for the losers.

The consolation round was won 5-4, also in a showdown by the Blue team coached by Wayne Anderson and Fred Hutchings, over the White team.

The Caisse Pop team took the top honors in the Midget play-offs, defeating the Red team 5-4, on goals by Marion Pivin (three goals); Luc Perras, and Alain Perras. Scoring for the losers were Joel Brunette, Dennis Brunette, Mike Gamble, and Gerry Ricard. Caisse Pop coaches were E. Robichaud and M. Perras, while Kirk Smythe and P. Brisebois coached the Reds.

The consolation round was won by the Blue (Lions' Club) team over the Racine-Kelly White team, coached by J. Leduc. Winning coach was K.

Oldham. Scoring for the Whites were R. Rember (two goals), S. Robichaud, T. Oldham, and Jason Robidoux. Moose goal-getters were Pascal Hurteau (two goals) and Brian Allen.

The season ended with the feeling that all teams played well, and most of the players have already registered for next year. The Minor Hockey Association expressed its gratitude to all the coaches, referees, and other volunteers who gave of their time to help the youngsters.

Howick

Mrs. Evelyn Lamb
The Howick Curling Club was a busy place over the week end. The annual 24 Hour Bonspiel took place with Howick, Riverfield and Ormstown participating.

Games began on Friday evening and continued with an early morning break, through until Saturday night. Three meals were served during Saturday ending with a spaghetti supper in the evening. Curling and hospitality were enjoyed. The winning skips were: Elmer Black, Ken McKrae, Barry Ness, and Bob Tennant.

TEL: (514) 264-5251
RES: 371-5664

Dr. YVAN PERREAULT

DENTIST

OFFICE HOURS
MONDAY TO FRIDAY: 8:30 a.m. to 5:30 p.m.
MON-WED: 6:30 P.M. TO 9 P.M.
SATURDAY: 8:30 A.M. TO NOON

79 WELLINGTON
C.P. 1656

HUNTINGDON
JOS 1HO

Gleaner ads: Tel. 264-5364

CEREAL SEED VARIETIES

OATS
Oxford
Scott
Elgin
Morris
Garry

BARLEY
Perth
Bruce
Laurier
Mingo
Bedford

WHEAT
Concord
Glenlea
Sinton
Laval-19
Ankra

ALSO AVAILABLE ARE 2 WAY
3 WAY
4 WAY CEREAL MIXTURES
AT COMPETITIVE PRICES

BRONN ENTERPRISES INC.

54 Church St.,
Ormstown

829-2547
829-3481

YOUR TIRE SPECIALIST

• SUPER SALE •

MICHELIN: 40% OFF (CR 78 x 14-DR 78-14) (14" & 15" M-S)
GOODYEAR: 50% OFF (TO PLANT EMPLOYEES)
PIRELLI: 30% OFF (SIZE 14" & 15" IN INVENTORY ONLY)

HONDA CIVIC 155Rx12	\$50.00
HONDA ACCORD 155Rx13	\$55.00
TOYOTA 155Rx13	\$55.00
DATSUN 155Rx13	\$55.00
MAZDA 155Rx13	\$55.00
RABBIT 155Rx13	\$55.00
SUBARU 155Rx13	\$55.00
HONDA ACCORD 165Rx13	\$60.00
VOLVO DR78x14	\$80.00
AUDI P185-70x14 R	\$85.00

USED TIRES
FROM
\$10.00

SPECIAL DISCOUNT
FOR FLEET OWNERS
- MILKMEN - GROCERS
- BAKERS - CONTRACTORS

WE REPAIR CAR AND TRUCK TIRES
"RADIAL AND CONVENTIONAL TUBES"

OPEN ON SATURDAYS AND EVENINGS BY APPOINTMENT WELCOME



Mercedes-Benz
WE BUY USED TIRES

MICHELIN

ROGER GAGNIER

243 DUFFERIN,
VALLEYFIELD

373-4194



We make it easy!

Because we can apply dry bulk fertilizer impregnated with Sutan™+ selective herbicide and atrazine. So all you need do to weed and feed your fields is make one trip—to incorporate the herbicide-fertilizer mixture.

What could be simpler? And you also reap the benefits of Sutan+—the best incorporated corn herbicide. You get outstanding control of foxtails,

crab grass, velvetleaf, fall panicum, nutsedge, barnyard grass plus a broad spectrum of other grass and broadleaf weeds with one herbicide program.

For an easier spring and better harvest this fall, stop by or call us today.

Sutan and Sutan+ are registered trademarks of Stauffer Chemical Company, U.S.A.

Sutan+ The best incorporated corn herbicide.

GERARD MAHEU INC.

289 RANG DU 5
ST-LOUIS-DE-GONZAGUE

TEL: 373-1420 373-8222
373-5845

Ormstown

The congregations of Ormstown and Rockburn Presbyterian churches met in the Ormstown church hall on Thursday evening, March 31 for their Maundy Thursday pot-luck supper. There were about 85 present.

A delicious variety of casseroles, salads and desserts was enjoyed. The Rev. Larry Paul of Georgetown Presbyterian church led in a sing-song and the choirs also sang.

Mrs. Alan Hooker, on behalf of the anniversary committee, presented the new stage curtains which were dedicated by Rev. Paul.

Following this, there was a table communion service conducted by Rev. Paul.

CHATEAUGUAY VALLEY

TEL-AID

829-2717

BOVAID EAR TAGS

\$6.50 OFF

BOVAID EAR TAGS FOR MONTH OF APRIL

**CONTROL HORN FLIES
REDUCE FACE FLIES
PROTECT AGAINST
PINK EYE INFECTION**

APPLY BOVAID EAR TAGS EARLY AND GET SEASON-LONG FLY CONTROL INCREASE MILK AND MEAT PRODUCTION

BUY NOW AND SAVE \$6.50 PER BOX OF 25 - OFFER EXPIRES APR. 30

BRONN ENTERPRISES INC.

829-2547

829-3481

Hinchinbrooke Council

Following a request by William Roach, Hinchinbrooke Council will investigate the placing of a tile across Fairhaven to give Roach some drainage.

The Council will also check into the removal of the waterhole at the corner of Fairview and Fairhaven Sts., it was decided at the April meeting.

A request was received from Herb Simpson for ditching along the Gowan Rd. The Roads Committee is to check.

A request was received from the Frontier No. 1 Boy Scouts to have permission to use the former municipal dump site on the Gowan Rd. for a reforestation project.

The request by the Rockburn Presbyterian Church to sell a piece of property and also the request by Mrs. Claudette Dufour to rebuild on her property were approved. The request by Maurice Bastien to sell a part of his farm is approved with the stipulation that the property remains agricultural. A copy of these resolutions is to be forwarded to the C.P.T.A.Q.

A resolution was passed that Hinchinbrooke will co-

operate with Elgin in asking the Quebec government to declare the covered bridge at Powerscourt an historic site.

The Roads Department is to be asked to lower the height-limiting bar on the Powerscourt bridge.

The cheques received from the Department of Recreation are to be cashed and the donations will be given out according to the council decision of February 1983.

The Council has designated Howard Welburn as Assistant Regional Inspector of the MRC.

The following people have been issued building permits in accordance with article 3.2.2 of the Interim Control by-law: Laurent Cartier, Gene Leslie, Don Frier and Jim Hutchings.

The Council is attempting to arrange two public information meetings to be held at the Town Hall with urbanist Christian Chaput as the speaker. The meetings are tentatively scheduled for Wednesday, June 1 in the evening, and for Saturday June 4 in the afternoon.

Bills in the amount of \$11,313 were approved.

Havelock Council orders illegal burning stopped

Following a letter of complaint and a visit from two Rang St-Charles residents, Havelock Council mandated municipal inspector Paul Pass to order closure of an illegal dump on that road.

Pass visited the site and told the operators to shut down, and to stop the burning which had threatened the neighboring properties, it was reported at the April 4 council meeting.

In other business, a tax refund of \$327.88 to the Havelock Fair was approved, as the fair has been granted non-taxable status by the government retroactive to 1980.

Paul Pass was named the municipality's assistant inspector for the MRC du Haut-St-Laurent.

Council resolved to approve the sale of Lot 173A by Jean-Yves Boileau to his sons, on condition that the land continues to be used for agricultural purposes.

Several requests will be made to the Ormstown office of the Roads Department.

The Department will be asked to move the junction sign on southbound Rte 203, indicating the Rte. 202

intersection, farther south. Confusion has resulted from the sign's proximity to a newly-paved driveway. Flashing lights will be requested at the intersection of Rtes. 202 and 203 and at the Rte. 202 - Rang St-Charles intersection.

The following ditching work will be requested: on the Montée Stevenson opposite the Hughes property; on the Montée Giroux north from Rte. 202; on the Covey Hill Road opposite the land of Delia Vaillancourt and Colvin Watt; and along Rte. 202 in front of the Palstra property.

The secretary was authorized to investigate the failure of Communications-Quebec to secure a municipal building permit for the new 220 foot communications tower on the north side of Covey Hill Road.

Council decided to cancel last month's resolution to ask the MRC evaluation office to compile a list of local businesses for tax purposes. Havelock simply does not have enough businesses to make such a costly procedure worthwhile, and the municipality will abolish its commercial tax in 1984.

Bills totalling \$4,373.88 were passed.

At the April 4 meeting of Godmanchester Council, Bill Martin was named municipal fire warden for 1983.

The following requests will be forwarded to the Ormstown office of the Roads Department:

1. to dig the ditch on Lot 56P for a length of 420 feet.

2. to clean ditches on Lots 290 and 291P, property of Clayton Murphy, over a length of about three acres.

3. to fill in a crack in the Ridge Road opposite the Real Carriere property.

The following bills were passed:

Salaries \$4,331.32; Receiver general \$385.48; Minister of Revenue \$463.46; MRC rent April \$150; Guy Provost \$1,695.83; Mutual

Assurance \$146.61; MRC (photocopies) \$40.48; Richard Alary \$550; Valleyfield Office Equipment \$72.29; J.A. Thompson \$26.71; Bell Canada (office) \$42.46; Hydro-Quebec (street lighting) \$708.16; MRC (evaluation office) \$2,978; Fire station: Bell Canada \$26.33; Bell Canada (emergency calls) \$17.55; Hydro Quebec \$409.68; Pierre Thibault (ladder) \$1,266.51; Aero Feu Ltd. \$217.46; Welburn Garage \$40.30; William H. Martin \$30.22; Royce Ruddock \$38.11; Rolfe and Son \$6.22; Huntingdon Auto Parts \$44.89; Radio station license renewal \$50.

Garage: Bell Canada \$12.75; UAP \$168.95; Aztec Rental Inc. \$54.50; Valleyfield Steel Inc. \$22.93; W.E. Lefebvre \$14.09; Welburn Garage \$94; Unipar Inc. \$98.31.

Serge Dupuis (backhoe service) \$96.

Godmanchester Council

At the April 4 meeting of Godmanchester Council, Bill Martin was named municipal fire warden for 1983.

The following requests will be forwarded to the Ormstown office of the Roads Department:

1. to dig the ditch on Lot 56P for a length of 420 feet.

2. to clean ditches on Lots 290 and 291P, property of Clayton Murphy, over a length of about three acres.

3. to fill in a crack in the Ridge Road opposite the Real Carriere property.

The following bills were passed:

Salaries \$4,331.32; Receiver general \$385.48; Minister of Revenue \$463.46; MRC rent April \$150; Guy Provost \$1,695.83; Mutual

Assurance \$146.61; MRC (photocopies) \$40.48; Richard Alary \$550; Valleyfield Office Equipment \$72.29; J.A. Thompson \$26.71; Bell Canada (office) \$42.46; Hydro-Quebec (street lighting) \$708.16; MRC (evaluation office) \$2,978; Fire station: Bell Canada \$26.33; Bell Canada (emergency calls) \$17.55; Hydro Quebec \$409.68; Pierre Thibault (ladder) \$1,266.51; Aero Feu Ltd. \$217.46; Welburn Garage \$40.30; William H. Martin \$30.22; Royce Ruddock \$38.11; Rolfe and Son \$6.22; Huntingdon Auto Parts \$44.89; Radio station license renewal \$50.

Garage: Bell Canada \$12.75; UAP \$168.95; Aztec Rental Inc. \$54.50; Valleyfield Steel Inc. \$22.93; W.E. Lefebvre \$14.09; Welburn Garage \$94; Unipar Inc. \$98.31.

Serge Dupuis (backhoe service) \$96.

H'ford Township Council plans for new fire truck

Main item of business at a brief April 5 meeting of the Hemmingford Township Council was presentation of a request from the local volunteer fire

department for the purchase of a new fire truck.

A delegation of firemen visited the meeting to present a petition signed by

all members of the department, requesting the new truck within the next year.

The present truck dates from 1965, and repairs and upkeep are becoming more costly. A new truck would cost in the area of \$100,000.

Council promised to study the issue, get cost estimates, and discuss means of financing, so that the purchase might be included under the 1984 budget.

"It will probably take a good year to get everything organized," said municipal secretary Roger Bouchard.

Council supported a de zoning request from Mrs. Erna Haslinger, who wishes to purchase a building lot on Rte. 202 from Madeleine Priest, and build a house on it.

Several requests for fencing and ditching work were recorded.

Bills totalling \$26,665.65 were passed.

By-law 143, concerning mutual aid agreements for fires and civil emergencies, was passed. This by-law places the fire chief and his assistant in charge of arrangements with the neighboring municipalities of St-Chrysostome, Sherrington, Napierville, and Lacolle.

Previously, the mayor (or pro-mayor) and two councillors were responsible in these cases, but now, chapter 189 of the Municipal Code calls for the fire department reps to take over.

In the case of Hemmingford Village, the fire chief is Gaëtan Fortin, and the assistant chief is Edmond Priest.

The secretary was authorized to make term deposits etc., in handling municipal funds during the current year.

Expenses totalling \$13,602 were passed.

Expenses totalling \$13,602 were passed.

Expenses totalling \$13,602 were passed.

Expenses totalling \$13,602 were passed.

Expenses totalling \$13,602 were passed.

Expenses totalling \$13,602 were passed.

Expenses totalling \$13,602 were passed.

Expenses totalling \$13,602 were passed.

Expenses totalling \$13,602 were passed.

Expenses totalling \$13,602 were passed.

Expenses totalling \$13,602 were passed.

Expenses totalling \$13,602 were passed.

Expenses totalling \$13,602 were passed.

Expenses totalling \$13,602 were passed.

Expenses totalling \$13,602 were passed.

Expenses totalling \$13,602 were passed.

Expenses totalling \$13,602 were passed.

Expenses totalling \$13,602 were passed.

Expenses totalling \$13,602 were passed.

Expenses totalling \$13,602 were passed.

Expenses totalling \$13,602 were passed.

Expenses totalling \$13,602 were passed.

Expenses totalling \$13,602 were passed.

Expenses totalling \$13,602 were passed.

Expenses totalling \$13,602 were passed.

Expenses totalling \$13,602 were passed.

Expenses totalling \$13,602 were passed.

Expenses totalling \$13,602 were passed.

Expenses totalling \$13,602 were passed.

Expenses totalling \$13,602 were passed.

Expenses totalling \$13,602 were passed.

Expenses totalling \$13,602 were passed.

Expenses totalling \$13,602 were passed.

Expenses totalling \$13,602 were passed.

Expenses totalling \$13,602 were passed.

Expenses totalling \$13,602 were passed.

Expenses totalling \$13,602 were passed.

Expenses totalling \$13,602 were passed.

Expenses totalling \$13,602 were passed.

Expenses totalling \$13,602 were passed.

Expenses totalling \$13,602 were passed.

Expenses totalling \$13,602 were passed.

Expenses totalling \$13,602 were passed.

Expenses totalling \$13,602 were passed.

Expenses totalling \$13,602 were passed.

Expenses totalling \$13,602 were passed.

Elgin... from page 1

that he has attended meetings on the new building by-law for the MRC; a building inspectors' convention in Laval; and a special session offered by the Department of the Environment on septic tank installation.

A resolution was passed asking the same department to hold a special five-day course on septic tank installation within MRC territory before next fall.

As recommended by the MRC du Haut-St-Laurent, Ben Lecluse was nominated as an assistant building inspector for the MRC. The plan is to have each member municipality name such an assistant, to work with a chief in-

spector, who will be named later by the MRC.

The covered bridge at Powerscourt, a historic structure and the only one of its type in North America, was visited recently by the council and representatives of the Ormstown office of the Department of Transport, following reports that it was in a poor state of repair.

This was found to be true, as the supports under the bridge had been badly worn by the current of the river. Repairs were begun last week by the Roads Department, and it was hoped that the bridge would not have to be closed to traffic during the repair period.

Both Elgin and Hinchinbrooke councils have asked that the covered bridge be classed as an historic site by the Quebec Historical Society. Christian Chaput, urban planner for the MRC du Haut-St-Laurent, will be asked to prepare a report containing background information on the structure to submit in support of the request.

Council asked inspector Lecluse to visit agricultural engineer M. Normandeau of Huntingdon MAPAQ office

concerning drainage work on the DeVries and DeMartin Watercourses. All the necessary paperwork for the projects was completed last year, and council is anxious to see the work done this summer.

Many complaints have been received recently concerning irregularity of garbage pickup in the municipality. Not only is garbage contractor G. Demers showing up at odd hours, but not all the garbage put out is being taken, a council source said.

Mayor Jim Gavin was authorized to study release clauses in the contract and to investigate alternate means of garbage collection.

Councillor Philippe Leduc was named pro-mayor for the next three months.

Councillor Peter Dagg gave notice of motion concerning a future by-law dealing with length of councillors' terms of office and frequency of municipal elections. Elgin finds the cost of annual elections prohibitive, and municipalities have the option, under the Municipal Code, of changing the system through a new by-law.

Bills totalling \$3,400 were passed.

H'ford... from page 1

ments for the youngsters. A \$75 donation was approved.

By-law 143, concerning mutual aid agreements for fires and civil emergencies, was passed. This by-law places the fire chief and his assistant in charge of arrangements with the neighboring municipalities of St-Chrysostome, Sherrington, Napierville, and Lacolle.

Previously, the mayor (or pro-mayor) and two councillors were responsible in these cases, but now, chapter 189 of the Municipal Code calls for the fire department reps to take over.

In the case of Hemmingford Village, the fire chief is Gaëtan Fortin, and the assistant chief is Edmond Priest.

The secretary was authorized to make term deposits etc., in handling municipal funds during the current year.

Expenses totalling \$13,602 were passed.

Expenses totalling \$13,602 were passed.

Expenses totalling \$13,602 were passed.

Expenses totalling \$13,602 were passed.

Expenses totalling \$13,602 were passed.

Expenses totalling \$13,602 were passed.

Expenses totalling \$13,602 were passed.

Expenses totalling \$13,602 were passed.

Expenses totalling \$13,602 were passed.

Expenses totalling \$13,602 were passed.

Expenses totalling \$13,602 were passed.

Expenses totalling \$13,602 were passed.

Expenses totalling \$13,602 were passed.

Expenses totalling \$13,602 were passed.

Expenses totalling \$13,602 were passed.

Expenses totalling \$13,602 were passed.

Expenses totalling \$13,602 were passed.

Expenses totalling \$13,602 were passed.

Expenses totalling \$13,602 were passed.

Expenses totalling \$13,602 were passed.

Expenses totalling \$13,602 were passed.

Expenses totalling \$13,602 were passed.

Expenses totalling \$13,602 were passed.

Expenses totalling \$13,602 were passed.

Expenses totalling \$13,602 were passed.

Expenses totalling \$13,602 were passed.

Expenses totalling \$13,602 were passed.

Expenses totalling \$13,602 were passed.

Expenses totalling \$13,602 were passed.

Expenses totalling \$13,602 were passed.

Expenses totalling \$13,602 were passed.

Expenses totalling \$13,602 were passed.

Expenses totalling \$13,602 were passed.

Expenses totalling \$13,602 were passed.

Expenses totalling \$13,602 were passed.

Expenses totalling \$13,602 were passed.

Expenses totalling \$13,602 were passed.

Expenses totalling \$13,602 were passed.

Expenses totalling \$13,602 were passed.

Expenses totalling \$13,602 were passed.

Expenses totalling \$13,602 were passed.

Expenses totalling \$13,602 were passed.

Expenses totalling \$13,602 were passed.

Expenses totalling \$13,602 were passed.

Expenses totalling \$13,602 were passed.

Expenses totalling \$13,602 were passed.



DUSSAULT AGRI-SERVICES INC.

59, MONTEE DU LAC

STE-BARBE

TEL: (514) 373-4625

Hewitt

MONTREAL

5001, rte. Transcanadienne, Pointe-Claire
tel. 697-6911

PASSEPORT-BONN

DAY

THIRD AND FINAL DAY

APRIL 16, 1983 - from 9 a.m. to 4 p.m.

Featuring: TRACK-TYPE LOADERS

Notice to all construction owners... or future owners:

Hewitt Équiment Limitée invites you to visit their Pointe-Claire premises for an unprecedented day of savings. You'll be able to tour the facilities, operate a piece of heavy equipment and take advantage of our many savings.

A complete explanation of our new PLUS 3 Program, including an extended 3-year or 5,000-hour warranty, will be given you.

Ask for your free passport ... to savings.

Come and meet us.

For more details, contact Don Tardio (514) 697-6911.



Succursales: VAL-D'OR HULL QUÉBEC CHICOUTIMI SEPT-ÎLES

bishop farm seeds

FORAGE SEED, MIXTURES
BISHOP & SPEARE CORN HYBRIDS AVAILABLE AT
BRONN ENTERPRISES INC.

54 Church St. Ormstown 829-2547
829-3481

Vacation in FLORIDA... where the Tropics begin!

A very special vacation haven in impeccable taste. New, uncrowded, unspoiled, charming, year-round resort. Ocean bathing, secluded oceanfront sunning area, poolside coffee shop/lounge, informal brunches.

HEATED INDOOR/OUTDOOR SWIMMING POOL

Gourmet dining in renowned ARENA "House of Fine-Beef" RESTAURANT

Famous Sunday lunch buffet, succulent entrees, top entertainment, live music, dancing. Each room has ocean view, elegant decor, color remote TV. Responsible rates prevail. Near smart shops, fishing, sailing, water skiing, tennis, golf. Come, reserve your own very special place in the sun!

Mail coupon today or phone Toll Free 800-325-3535

Sheraton Regency Resort Hotel

On the Beach 4700 No. A1A VERO BEACH FLORIDA 32960

NAME: _____ ADDRESS: _____ CITY/STATE/ZIP: _____ CALL 305-231-1600 Dept. A1A

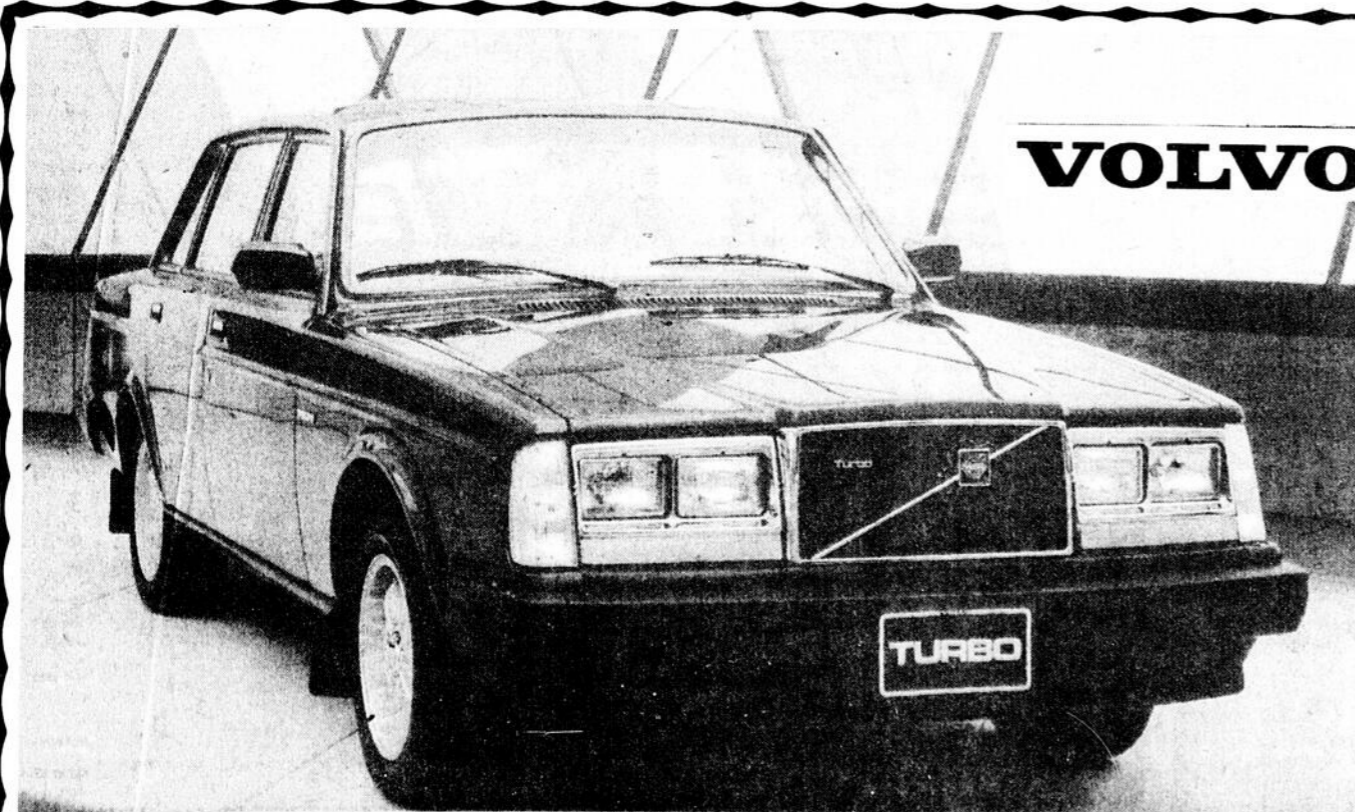

OPERATION: MARKDOWN!

\$1,000.00 REBATE

ON ALL VOLVO MODELS IN OUR INVENTORY

Gleaner ads: Tel. 264-5364

Woolly lambs steal hearts at Dewittville WI meeting

"Baa, baa, black sheep. Have you any wool? Yes sir yes sir, Three bags full."

This little nursery rhyme could well have been used as a theme for the Dewittville W.I. meeting at Sharon Weippert's home on March 3. That evening about 30 members thoroughly enjoyed a visit to the sheep barns with commentaries by Nelson Weippert.

Two ewes with new twins were the first "woolies" we visited; from there it was on to orphans and older lambs, then yearlings and ewes with winter lambs.

Questions about breeding and feeding were answered, then Nelson gave a shearing demonstration and most members were surprised to see how large a fleece really is. Many would have loved to have tucked a wee lamb in their jackets, but the group returned to the house for lunch so the secret would have been out even if one could have kept it quiet.

Prior to the barn visit the annual meeting was held indoors with president Esther Cavanagh in the chair.

The meeting opened with a welcome to our guests. For roll call members paid their 1983 membership fees.

Plans for the 25th anniversary meeting were made. As other W.I.'s in the Valley are to be invited it was decided to hold the meeting at Walshaven which is central and convenient. The date was set for May 19 at 7:30 p.m.

Starting in June, the regular meetings are to be held the first Wednesday of the month instead of the second Thursday.

Conveners reports Agriculture: Rosemary Mason read an article entitled "Word of Mouth advertises Lamb" about marketing lamb.

Home Economics: Margaret Munro's article "Choose Nutrition Now - It Pays" was a reminder that March is nutrition month in Canada.

Annual reports were read by the conveners for Agriculture, Education, Home Economics,

Publicity and Welfare and Health.

Ellen Bulow, as chairperson for the Nominating committee, presented the following slate of officers for 1983.

Past President - Shirley Scott; President - Esther Cavanagh; Vice-President, Marion Ruddock; Secretary, Nancy Eades; Treasurer, Pamela Thwaites.

Conveners: Agriculture, Rosemary Mason, Citizenship, Beatrice Sherry, Education, Carolyn Cameron, Home Economics, Margaret Munro, Publicity, Hazel Aikman, Welfare and Health, Sharon Weippert.

Committees: Program Committee - Marion McMillan, Jane Younie, Ruth Sundborg;

Refreshment Committee: Ellen Bulow, Rosemary Mason; Remembrance cards - Phyllis Todd.

Esther Cavanagh thanked the members for their co-operation in the past year and expressed hope for a great year ahead.

Ormstown

Mrs. Jean McEwen

Debbie McCaig spent part of last week with her parents, Mr. and Mrs. Jim McCaig, following a two-week vacation in Hawaii, in 90-92° temperatures. She visited the islands of Oahu and Maui On Oahu, there was a boat trip around Pearl Harbor with many interesting sights including the ship Arizona which sank during the attack. There was a Mormon Temple, the Polynesian Culture Centre, an international Market featuring cultures of the Polynesian people and native handicrafts, as well as many other interesting things.

On the island of Maui, they attended a "luau" with the traditional foods and entertainment including hula dancers.

An unforgettable experience was watching the sunrise at 6:15 a.m. from the top of the crater of the dormant volcano "Haleakala", which means "The House of the Sun". The crater resembles the surface of the Moon rather than lush Hawaii. They saw the famous Banyan Tree which was planted in 1873 and has now spread over a full acre of land and shades almost the entire town square. Add on field after field of pineapples and sugar cane, the friendliness and hospitality of the Hawaiian people, the beautiful beaches plus many other sights and the whole becomes an unforgettable trip.

Mr. and Mrs. Allan Cavers are home after spending the winter at Dade City, Florida.

Mr. and Mrs. Clifford Moore arrived home last week after a month's vacation at Jekyll Island, Georgia.

Ormstown W.I. names officers

The annual meeting of the Ormstown W.I. was held at Walshaven with President Connie Black presiding. Twenty-six members attended. The roll call was answered by the payment of annual fees. The conveners' annual reports were read and approved.

Treasurer Kathleen Bidwell gave each member a copy of the financial report.

The nominating committee of Margaret Mack, Ruth Towns and Mildred Hay presented a slate of officers which was read by Mildred Hay. The following officers were declared elected as there were no nominations from the floor.

President - Mrs. Connie Black; Vice-President -

Mrs. Willa Hooker; Secretary - Mrs. Mary K. McGerrigle; Treasurer - Mrs. Kathleen Bidwell.

Conveners: Agriculture - Mrs. Alice English; Citizenship - Mrs. Shirley Carmichael; Health and Welfare - Mrs. Arlene Cottingham; Home Economics - Mrs. Ruth Towns; Publicity - Mrs. Margaret Mack; Education - Mrs. Willa Hooker; Program - Mrs. Mary McGerrigle; Refreshments - Miss Mildred Hay, Mrs. Bea McGerrigle, Mrs. Winnie Marshall, and Mrs. Arlene Cottingham; Cards - Mrs. Hazel Bradley; Pianist - Mrs. Ben McGerrigle.

Mrs. Hazel Bradley was thanked for her excellent job of remembering sick members.

Rink... from page 1

recreational activities in the municipality.

The following evening, the council of St-Malachie d'Ormstown proffered an equal amount, also to come from next year's grant allocation.

"When we had ice, people certainly did come out to skate, although we can't deny that activity at the Ormstown rink has been affected in recent years by the programs offered at the Huntingdon Regional Arena, where many youngsters enjoy the longer skating season on artificial ice and the benefits of an organized minor hockey program." Guérin told the Village council.

"One thing for sure - before getting going on the ice-skating program next winter, the Lions' Club will consult with both councils as to its feasibility," he said.

The Ormstown Lions Club has operated the rink in the fairgrounds arena for many years now, with volunteers handling the maintenance and supervising the skaters.

Howick

You will probably be reading the news of the 4-H Square Dance contest elsewhere in the paper. Appreciation should be voiced for this event and all its participants. Congratulations are well deserved by the top winners from Lachute and the runners up from Howick's junior team. Support is given to the 4-H movement by many people at many different times and on Saturday evening some of those nice people got a thank you in return when some prizes were drawn and awarded. The winners were Sophia West (a quilt made by the Handicraft Club), Thyra Tolhurst, Joe Andert and Iris Woods. The widespread support of the 4-H project was very much appreciated.

Aubrey - Riverfield

The Riverfield Presbyterian Church sponsored a successful Pancake Supper on Friday April 8, feeding a hungry crowd all the homemade pancakes and sausages they could eat. New maple syrup, hot coffee and tea with donuts rounded out the meal. Tempting bake sale and handicraft tables offered an attractive variety of items.

The Riverfield Ladies' Curling Club finished its regular season of play with the April Fool Bonspiel played on March 30.

First place winners were: Judy Nussey, Isabel Angell, Velda Brown, and Bev. McFarlane. In second place were: Elaine McKell, Sybil Gruer, Joan Hampton and Nicole Carmichael. Door prizes were awarded to: Dot Carrigan, Mareen Orr and Judy Nussey. A wine and cheese buffet was a well enjoyed feature of the evening.

Winners from other club events were announced. Top teams in the Maude

Allen Bonspiel were: Susan Nussey, Agnes Chartrand, Anita Craig and Mareen Orr, and in second place: Marion Templeton, Gail Craig, Marina Templeton, and Velda Brown. In the Spring Bonspiel the winners were: Susan Nussey, Gertie Allen, Velda Brown and Karen Stacey. Runners up were: Faye Craig, Elaine McKell, Jennie McKell, and Marguerite Beaudoin.

Club president, Marilyn Stacey presented the prizes to the teams who won the President's Prize Competition. Winners were:

Faye Craig, Gail Craig, Anita Craig, and Millie McKell while the second place team was: Margaret Robertson, Judy Nussey, Theresa Landry, and Marina Templeton.

All agreed they had enjoyed a good season of "the roarin' game" with plenty of home games and several events at other clubs in the area where the Riverfield teams did quite well.

F.C.C.... from page 1

market borrowings. I am optimistic that an even greater number of farmers will get loans this coming year," added the agriculture minister.

Effective the same date was the reduction of the rate under the Farm Syndicates Credit Act to 11½ per cent. This represents a four and one quarter per cent decrease.

Athelstan

Mrs. Janet Grant

Final plans are now complete for the spring fund-raising dance sponsored by the Athelstan Community Sports Association (see ad).

For all those party-goers who have spent a long quiet winter in front of the T.V., Saturday, April 23 is a date to remember. The Trout River Golf Club will be the scene of the first dance of the season and the Country Cats orchestra will be on hand to ensure a pleasant evening for all who attend. A midnight lunch is planned by the dance committee and door prizes will add to the general good time. The proceeds will be used for the 1983 sports season at the Athelstan Ball Field.

Ormstown

Mrs. Jean McEwen

Mrs. Harold Parkinson spent Easter week-end with Mr. and Mrs. Harley Parkinson and family at Chateaugay, Que. Mr. and Mrs. J.W. Gartshore of St. Bruno were dinner guests at the same home on Saturday evening.

Hemmingford

Aileen L'Esperance 247-2558

On Saturday evening, March 26, the Ladies Auxiliary of the Hemmingford Medical Centre held a successful card party in the basement hall of the Senior Citizens' Centre.

President Mrs. Gerald Ellerton welcomed everyone and thanked them for supporting this worthwhile project. The donors of gifts, prizes, food and assistance were also thanked. Mrs. June Palmer, speaking in French, welcomed everyone and echoed Mrs. Ellerton's words of appreciation.

There was a good attendance with cards played at 12 tables and once again, judging by the number of winners at cards and door prizes presented, it would seem that very few went home without a prize, all donated by local merchants and well-wishers.

The winners among the ladies were (in numerical order): Lois Mills, Mildred Robert, Irene Ellerton, Georgette Laberge, Hazel English, Joyce Oakley, Evelyn Hadley, Lillian Dauphinais, Estelle Tobin, Florence Ellerton, Charlotte McAdam, Grace Brownridge, Consolation, Lillian Hawkins.

Winners among the men were: Gérard D'Amour, Gerald Ellerton, Percy Baskin, Aylmer Hadley.

A lot of people call life "The Survival of the Fittest". You know, a lot of people are right.



LAWN-BOY SPRING CHECK-UP SPECIAL!

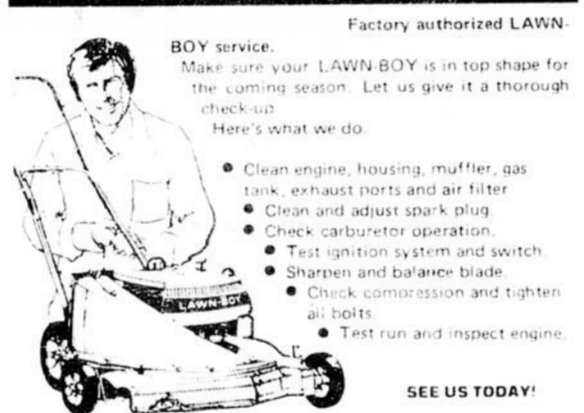

Factory authorized LAWN-BOY service. Make sure your LAWN-BOY is in top shape for the coming season. Let us give it a thorough check-up. Here's what we do:

- Clean engine, housing, muffler, gas tank, exhaust ports and air filter
- Clean and adjust spark plug
- Check carburetor operation
- Test ignition system and switch
- Sharpen and balance blade
- Check compression and tighten all bolts
- Test run and inspect engine

SEE US TODAY!

ATHELSTAN ELECTRIC
264-5704

81 RIDGE RD. ATHELSTAN

LAWN-BOY

As time goes by, you'll know why.



CORN SEEDS AVAILABLE IN 2200 TO 2900 HEAT UNITS

3 WAY CROSS AND SINGLE CROSS

- SEEDGRASS • SORGHUM - SUDANGRASS
- SILA-BAC SILAGE INOCULANT

FOR BETTER YIELD • BETTER FEED SILAGE

YOUR DEALER FOR

STE-AGNES • ST-ANICET • HUNTINGDON • ELGIN AREA

CALL

LEONARD LEBLANC

264-2119

6043 RIDGE

STE AGNES-DE-DUNDEE

CLUB VIDEO HUNTINGDON ENR.

NOW AVAILABLE
COLECO VIDEO GAME

(FOR COLOR TV ONLY)

SPECIAL OFFER
RENT A VIDEO RECORDER **1/2 PRICE** ON TUES. AND WED.

MEMBERSHIPS \$30.00
FILM RENTALS \$3.00 PER DAY

VHS FILMS AVAILABLE STARTING APRIL 15

CLUB VIDEO HUNTINGDON ENR.

MON. TO FRI. 5 P.M. TO 9 P.M.
SATURDAY 1 P.M. TO 5 P.M.

LOCATED AT

6 PICARD ST.

TEL: 264-2943

HUNTINGDON

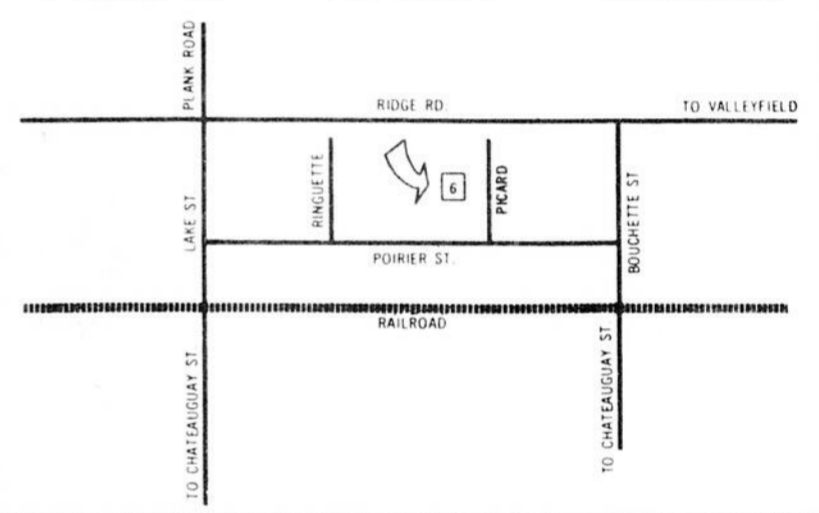

DATSUN ANNOUNCES

9.9% ON ALL NEW 1983 DATSUN TRUCKS

NO GIMMICKS. NO HIDDEN QUALIFIERS.

Now when you buy any new 1983 Datsun truck, you can finance up to \$10,000 for only 9.9% Net for just the first year. Net for two years. But for up to 42 months. Which makes it one of the best factory-backed deals you'll find anywhere. So if you've been waiting for interest rates to come down, your wait is over. And it applies to all new 1983 Datsun trucks. Four-wheel drive or two-wheel drive. Gas or diesel. Long box or regular. And the one and only King Cab. Prices on this great line-up of tough



DATSUN
PRODUCT OF NISSAN

MERCIER DATSUN

WE'RE NUMBER ONE



55 ST. JEAN BAPTISTE WEST-MERCIER

TEL.: 691-9541

SHORT & LONG TERM LEASING

ASPHALTE L. VERNER INC.
 GENERAL CONTRACTOR IN ASPHALT
 LEVELING - SOIL - FINISHING - PEAT
 MOST MODERN EQUIPMENT
 58 Route 132 Tel: 514-373-5072
 51-Stanislas-de-Kostka FREE ESTIMATE

MASTER FEEDS
M. SMITH REP.
 Barrington, Que. Tel: 247-2380
**COMPLETE FEEDS,
 FARM SUPPLIES, PET FOODS**
 We are now taking orders
 for baby chicks & turkey poulters

**PICK-UP OF
 DEAD ANIMALS**
 HORSES - COWS - CALVES - HOGS, ETC.
 CALL COLLECT: 454-9434 or 454-3274
 (New Administration)
 JEAN MARIE LEFRANCOIS ENTREPRISES INC.
 CHRISTIAN OR JEAN-MARIE
 WE PAY AND PICK-UP
 DEAD OR LIVE ANIMALS AT BEST
 FAST SERVICE 7 DAYS A WEEK
 43 STE-THERESE STREET, ST-REMI

**INCOME TAX
 RETURNS PREPARED
 (FROM \$10)
 A & L SLEDGE
 HEMMINGFORD
 FOR APPOINTMENT CALL
 247-2194**
 Member, Canadian Federation of Tax Consultants

**Clinique Vétérinaire
 de Huntingdon**
Dr. Pierre Poitras
 1708 Châteauguay, C.P. 1448,
 Huntingdon, Que. J0S 1H0 Téléphone 264-6202

**TOOLS & EQUIPMENT
 RENT IT AND SAVE**
 • RENTALS
 • SALES
 • SERVICE
 CENTRE DE LOCATION
PYRAMIDE
 RENT ALL CENTRE INC
 172 ST-JEAN-BAPTISTE, CHATEAUGUAY 691-5231
 2051 THIERRY - LASALLE 363-2546

**FOR APPOINTMENT
 CALL 264-3776**
JEAN-FRANCOIS HOLLARD
DENTUROLOGIST
 Certified Dental Technician
 • PARTIAL AND COMPLETE DENTURES
 • FAST REPAIR SERVICE
 Welfare Accepted
 Huntingdon - 158 Châteauguay
 Ormstown - 49 Bridge

AUCTION
**FOR MRS. ANN-MARIE DORAIS,
 2 MI EAST FRANKLIN CENTRE, RTE 202
 SATURDAY, APRIL 23
 AT 12 NOON**
 An auction of good quality furnishings, antique
 dishes, paintings, rockers, kitchen set, round table,
 many many toys, etc.
 Terms - Cash
 Sale under cover.

LYELL J. GRAHAM
AUCTIONEER
 Athelstan Tel: 264-2289

AUCTION
FURNISHINGS, ANTIQUES ETC.
**SATURDAY, APRIL 16
 - 12 NOON -**
**AT THE RESIDENCE OF
 MISS ETHEL WILLIAMS,
 WILLIAMS ROAD,
 NORTH OF HEMMINGFORD**

Partial list includes large antique pine armoire,
 antique dressers and commodes, antique rockers,
 antique kitchen chairs, beautiful maple hutch,
 curved-top trunk and others.
 Old picture frames, old captains chair, single and
 double beds, Belanger refrigerator, Kenmore
 automatic washer and dryer. Dishwasher, large
 Admiral deepfreezer (chest type), 30 in. el. range, 2
 rugs 9 x 12. Swag lamp and 2 matching table lamps,
 2 wardrobes, dressing table, el. sewing machine,
 coffee and end tables, china cabinet, sofa (oak
 trim), artificial fireplace.
 Bedding, kitchen utensils, electrical appliances.
 Cedar chest, wringer washer, portable typewriter,
 portable TV and other items not listed.
 Reason for sale - giving up housekeeping.
 Terms - Cash
 Refreshments
 If rain, sale will be under cover.

LYELL J. GRAHAM
AUCTIONEER
 Athelstan Tel: 264-2289

Franklin
 Percy and Isabel Sutton
 spent a marvellous day in
 Nashville, Tenn. on March
 26.
 After tons of Nashville
 stars' homes and of Con-
 way Dwitty's City, they
 went to Opreyland. Though
 it rained hard, they saw
 many good indoor shows.
 The best of course was the
 Grand Ole Oprey at 7 p.m.
 The couple then completed
 their trucking delivery, as
 it was a "busman's holi-
 day", arriving home
 Monday. What a very
 special way to celebrate a
 30th wedding anniversary.
 Ernest and Muriel
 Sutton and family; and
 Isabel Sutton and family
 were Easter Sunday
 dinner guests of George
 Marlin and Ralph and
 Carolyn Marlin. Other
 family members there
 included the Howard
 Marlin family.

**Huntingdon
 Locals**
 On Easter Sunday a
 presentation of a pulpit
 reading lamp was made to
 the Huntingdon United
 Church. This was given by
 Russel Milne to the glory of
 God, and in loving memory
 of his wife, Bessie Pearl
 Milne.

PIANO TUNING
 Repair and Restoration
 Tel: 829-2831 or 3517
 Aaron Bousel
 Patience Bousel
 ORMSTOWN

**ANNUAL
 MEETING
 ORMSTOWN
 UNION CEMETERY**
 Co. Ltd
**MONDAY,
 APRIL 25**
 2 p.m.
 McDougall Hall
 Ormstown

BILL HOOKER
 (514) 829-2663
 ORMSTOWN, QUEBEC
**FARM MACHINERY &
 HOUSEHOLD AUCTION**
**AT THE RESIDENCE OF
 THE LATE MR. LIS GERVAIS
 724 RANG 3, STE-CLOTHILDE, QUE**
**DATE: APRIL 16, 1983
 TIME: NOON**
 Auctioneer: Bill Hooker - 829-2663

AUCTION
**FOR ALBERT RIENDEAU
 157 RANG ST-FRANCOIS, SHERRINGTON
 SATURDAY, APRIL 23
 AT 1 P.M. SHARP**
 Tractor: Inter. 724.
 Machinery: Self propelled combine Inter. No. 105
 excellent condition, grain seeder 16 drill Inter. with
 double disc, hay dryer 5 HP, suspended hay con-
 veyer 108' - hay elevator 32' - feed bin Victoria 9 ton
 with auger, 2 row corn planter Ford no. 309, hay side
 rake on rubber, fertilizer spreader 3 PH, Heston
 haybine no. PT 10, 34 HP grain auger 16', 3 PH corn
 chopper Kuhn, Inter. No. 56 corn blower, Tecnomia
 100 gal. sprayer, Inter. No. 595, manure spreader
 300 bushel, new, Kasten chuckwagon, N. Holland 288
 baler. Ford forage harvester, pasture harrows.
 Stable equipment: 2 pipeline weight scale, Laval,
 De Laval bulk tank 400 gal., automatic bulk tank
 washer, De Laval, hot water tank 60 gal, electric
 heater, De Laval pipeline 4 unit, feed cart, straw
 chopper, Proulx with battery, Patz silo unloader 16'
 completely rebuilt. Beatty barn cleaner, air
 compressor Côté evacu Air 3 HP, 50 ton corn silage.
 Reason for sale - Giving up Dairy
 Terms - Cash or good cheques
 For more information or credit arrangements
 please contact the auctioneer
ROGER D'AOUST
 Bilingual Auctioneer
 1189 Upper Concession
 Ormstown 829-3487

HUNTINGDON ASPHALTE
ROOFING OF ALL KINDS
RESIDENTIAL - COMMERCIAL - INDUSTRIAL
264-6268
 9 BENNI HUNTINGDON

CHAMPLAIN DRAINAGE
 253 RTE 138 ORMSTOWN
**NOW, more than ever you must get the highest return
 per acre.**
NOW, more than ever Drainage Pays
SO CALL US NOW FOR YOUR DRAINAGE WORK IN 1983
 • BEST SERVICE • BEST QUALITY WORK & SUPPLIES
 • NEW ENGINEERING SERVICES
**TEL: 829-3626
 3225**

**FOR YOUR
 SUGARING PARTY**

**... a shanty with a
 different atmosphere**

L'erablière
 inc.
 rte 201, st-louis-de-gonzague
 beauharnois county,
 6 km north of ormstown
 social clubs
 senior citizen groups
 associations
 and all employees
 reserve now so you won't
 be disappointed
 for information
 tel: 514-371 7863 • 371 4530

**CONSTRUCTION
 MAURICE PERREault**
 GENERAL CONTRACTOR
 RESIDENTIAL
 AND COMMERCIAL
 CONSTRUCTION
 RENOVATIONS
 REPAIRS
 TEL: 264-2970, 373-6779
 HUNTINGDON

**AUCTION
 SALE**
**ON THE FARM PREVIOUSLY OWNED BY
 ROLLAND BOUCHER
 BENOIT RANGE
 SAINT-ARMAND
 (MISSISQUOI CTY)
 TUESDAY, APRIL 19th 1983
 AT 1 P.M. SHARP**

Will be sold a good herd of 91 head of Holstein cattle
 all recently tested and qualified for export [USA].
 This herd includes 50 good cows with several fresh -
 others due to freshen soon, and a few rebred for fall;
 13 lovely heifers including 10 bred and 3 open, 18
 other nice heifers between 11 and 15 months of age;
 and 10 breeding heifers of 6 months.
 Equipment: One Wick 15 ft. adjustable silo tumbler;
 Ideal straw cutter with a 5 HP gas motor; hoof
 trimming rack; Cocksutt 16 disc combination
 seeder and fertilizer with clutch; Lily phosphate
 spreader with 3 pt hitch; New Holland no. 770
 chopper with a 2 row corn cutter; International No.
 46 hay baler; International 4 furrow plow, mounted
 type, 2 wheel trailer; 120 ft. ceiling type conveyor
 with a 1 hp motor, Ideal barn installation [new] for
 54 cows with synchronized releasing, 30 Ideal water
 bowls with cow chains,
 Barn installation for 26 heifers, with tubing and
 chains, 9 BCB calf cages, hay feeding trough, 3
 Vitamin feeding troughs; Oiler post, 2 electric fly
 pumps electric fly killer, 4 horn cutters, carriage
 and 300 cedar posts of 7 ft. also one Surge pipeline
 [new] with installation for 54 cows, 2 inch tubing, 4
 milking units and automatic washer, one 500 gal.
 capacity Dari-Kool bulk tank, and one 14.6 x 46 ft.
 Martin silo.
 Cause of sale: Specializing in agriculture
 Terms: Cash or bank loan
 For information or credit arrangements contact the
 auctioneer

JULES CÔTÉ INC
 1274 rue SUD Cowansville, Que
 Licensed Bilingual Auctioneer
**263-0670
 263-1434**

**AUCTION
 SALE**
**ON THE FARM PREVIOUSLY OWNED BY
 LOUIS BERARD
 450 GRANBY STREET
 BROMONT
 (SHEFFORD CTY.)
 WEDNESDAY, APRIL 20th 1983
 AT 1 P.M. SHARP**

Will be sold: 40 good head of Holstein cattle all
 recently tested and qualified for export [USA]. This
 herd includes 31 good cows with a few fresh and
 others due to freshen soon; 8 lovely breeding
 heifers; and 1 young bull.
 Machinery: one Oliver no. 550 gas tractor with cab;
 one Oliver no. 55 gas tractor; set of ring type
 chains; Oliver no. 62-T hay baler, New Holland side-
 delivery rake; 15,000 watts Fidelity generator.
 New Holland 7 ft. mowing machine [new] with 3 pt.
 hitch; 32 ft. bale elevator with motor; wagon on
 tires with hay rack, 130 bushel capacity Oliver
 manure spreader on power take off. 16 x 32 trailing
 model disc harrow, steel roller, stone boat, snow
 blower, 2 wheel trailer, 3 furrow plow with 3 pt.
 hitch, 3 section spring tooth harrow, scraper with 3
 pt. hitch; Oliver 2 furrow plow with 3 pt. hitch, feed
 carriage, Cocksutt 13 disc combination seeder and
 fertilizer, barn cleaner with a new chain of 172 ft.
 and all the shed stock.
 Also one DeLaval mucker compressor with motor; 3
 DeLaval magnetic pails; one 300 gal. capacity John
 Wood bulk tank, double wash tub, Cascade 40 hot
 water tank; and the remaining hay.
 Cause of sale: The farm is sold
 Terms: Cash or bank loan
 For information or credit arrangements contact the
 auctioneer

JULES CÔTÉ INC
 1274 rue SUD Cowansville, Que
 Licensed Bilingual Auctioneer
**263-0670
 263-1434**

A matter of good management!

 You know that in
 order to obtain high
 yields, you have to
 establish a proper
 fertilization and
 crops program.
 Why do it alone?
 Get in touch with your
 Coop dealer; he will
 inform you about the
 latest findings in
 crops and fer-
 tilization techniques.
 Profit from his ex-
 perience. It is a
 matter of good
 management.
DUSSAULT AGRI-SERVICES INC.
 59, MONTEE DU LAC STE-BARBE TEL. (514) 373-4625

PLACE A CLASSIFIED AD QUICKLY...EASILY...

CLASSIFIEDS TAKEN UNTIL 12:00 NOON MONDAY AT THE LATEST

JUST PHONE

264-5364

- FOR SALE
- FOR SALE
- FOR SALE
- FOR SALE
- WANTED TO BUY
- SERVICE
- ROOM & BOARD

HOMELITE, STIHL, Husquarna, Jacobsen sales and service, chain oil on tap \$4.50/4 litres; 16" chain \$14.50; equipment rentals and repairs. Ask about our saw of the month special. Location Hemmingford. Tel: 247-2968.

CORN FED yellow chickens 7 to 9 weeks old, .85 lb. Processed. Call after 6 p.m. 264-4438.

HAY AND haylage. Gordon Lang. 829-2057.

DUALS 1 - 18.4 x 38 hub type duals to fit J.D. tractor; 1 set of 15.5 x 38 snap on duals. Tel: 264-5198.

LARGE TRAILER to hitch behind tractor. Tel: 371-1259.

ANTIQUE LIVING ROOM set, antique loveseat and two chairs one buffet, one Inglis mini-washer, almond color. Tel: 264-3083.

FREEZER 12 cu. ft. Tel: 264-3272.

ANTIQUES OF all kinds furniture, dishes, lamps, bells, clocks, sleighs, buggies, etc. Complete or partial estates or households, also collections. Robert Thompson, Box 211 Hemmingford, Tel: 514-247-2557.

EXPERT CANING rush work. A variety of materials and designs. At the house of quality antique pine furniture. The Cedar House Antiques, 5071 Hwy 138 [8 miles south of Huntingdon, Que.] 264-3226. Tel: 514-247-2557.

GOOD ROOM and board for the elderly in private home. Tel: 264-3195.

QUALITY FURNITURE - at reasonable prices, Inglis, RCA, Ronton, etc. Larry Sinray Furniture Ltd., 39 Grande-Ille, Valleyfield. Tel: 373-1222.

1976 CHEV 1/2 ton pickup with fiberglass Curtis top 3 speed std in nice condition. \$1100 or best offer 264-4673 after 7 p.m.

1982 LADA, very good condition. \$3900. Tel: 264-3075.

1977 DODGE Tradesman van, \$2,000. Tel: 829-3723.

WESTINGHOUSE 30 in. stove, white, like new. Tel: 829-3156 after 3 p.m.

WE BUY antique and used furniture. Piano, dining room set, tea wagon, tables, chairs, standard or corner cupboard, complete or partial household estates. Julien Lefebvre, 1261 St-Louis St., Beauharnois. Tel: 1-429-4489.

EXPERT STRIPPING and furniture refinishing done by hand. Available year round at Ormstown Antiques, 2545 Highway 138, one mile east of Ormstown. Tel: 829-3714.

BOARDING AND grooming for your dogs and cats. Large spacious runs with personal attention. Lumson Kennels, Rockburn. 827-2704.

MASSEY FERGUSON No. 52 disc harrows on rubber, new cylinder and hoses. Tel: 264-6245 or 6297.

1979 FIREBIRD Esprit fully equipped \$5800. Tel: 373-0295.

G.E. 26" cabinet color TV. Asking \$200. Tel: 264-3209.

PROPERTY FOR SALE

ORMSTOWN 6 1/2 room house, outside storage shed. \$17,500. Tel: 264-6007.

THE CHIMNEY Sweep, oil and wood chimney service, group rates, installation and repairs. Brent Bown. Tel: 827-2406.

SOCIETY FOR the Protection of Animals [Shangri-La] - adoption centre for dogs and cats, examined and vaccinated by veterinarian. Boarding service. Clean and heated kennel. Tel: 373-0295.

BE SURE to purchase your copy of the 1982 Chateaugay Society Journal on Franklin St., Barbe, now \$6.00 plus \$1.00 for postage and handling to P.O. Box 61, Howick, Que. J0S 1G0.

REGISTERED AP- PALLOOSA gelding 7 years old, well trained for English and Western pleasure, registered quarter horse bay yearling filly by Spring Diamond, very well mannered. Tel: 264-5519.

QUANTITY OF red cedar pickets 7 feet long, ranging from 3 inches to 8 inches in diameter. David Coffey Tel: 264-2228.

HOUSE FOR sale, 3 bedrooms, located in town of Huntingdon. Available July 1st. Tel: 264-5305 days or 264-2969 nights.

TWO BEDROOM house on a good lot in village of Hemmingford. Reply in writing to Gleaner Ref. Box 3606, P.O. Box 130, Huntingdon, Que. J0S 1H0.

I AM interested in completing personal income tax returns for 1982. For more information call Liz MacDonald at 264-3539 eyes.

7 WEEK outdoor puppies to a good home. Tel: 264-4093.

HOMELITE, JONSERES and McCulloch chain saws, parts sales and service also small gas engines repaired. Chains sharpened, Jacobsen push and riding lawn mowers. Bill MacDonald. Tel: 264-3539 or 264-5554 Huntingdon.

1978 HONDA Motorcycle 400cc. Tel: 264-3855.

SECTIONAL SOFA, black vinyl, \$50. Tel: 264-6235.

PROPERTY FOR SALE

DISC HARROW 38-40 discs; two loads of hay or oats straw. Tel: 264-2635.

PAINTING, INTERIOR and exterior, plus carpet cleaning and any major cleaning job. Reasonable rates. Tel: 825-2368.

TO GIVE AWAY

TROY BILT, roto-tiller, power composters at factory prices. Alternatives 156 Chateaugay. Tel: 264-6245.

SPLendid OPPORTUNITY for you to purchase a nearly new equipment at fair market value. Massey-Ferguson 520, 12 ft. 40 inch disc on duals, \$2250; Hardi NK 400, 400l, 6 meter high-low 3 pt. hitch sprayer, \$1150; Massey-Ferguson 82 four bottom 16 inch 3 pt. hitch plow \$1100; John Deere 45 self propelled combine, two row corn head, ten foot grain table, direct cut and pick-up unit \$2500; school bus [running condition] \$500. Tel: 514-829-3483.

500 BALES of hay; also one land roller. Tel: 825-2106.

PROPERTY FOR SALE

8 ROOM house in Ormstown with land 126' x 80', with water and sewer, outside finished with new clapboard. Available July 1st. Tel: 829-3231.

WORK WANTED

FOUND

CHICKS FOR meat or laying. Ducks, geese, pheasant, quail, partridge, guinea fowl, turkeys, etc. Ask for price list. Chenil Efil, St-Stanislas. Tel: 371-5018.

1975 CAMARO LT red, new paint, 350 cu. in. 4 barrel 4 speed, lock differential, tilt steering electric windows in excellent condition. Price \$2400. Tel: 371-3803.

ELECTRIC "Majestic" calculator, almost new, \$40; Underwood model 5 typewriter, good condition, \$75. Tel: 264-2119.

PROPERTY FOR SALE

3 BEDROOM, fireplace living room, dining room, den 1 1/2 baths, on Route 11 Ellenburg Depot, N.Y. Priced for quick sale. Phone [518] 594-7562.

COOK 8 yrs. experience in Italian, Canadian and a little Arabian foods, looking for day time work. Tel: 829-2905 ask for Denis.

GEORGE KENNEDY C.A. Lacroix Vaillancourt & Associates Chartered Accountants Comptables np-Agrés Tel: 382-6370 26 Croissant Richard Chateaugay Centre, P.Q.

LIQUIDATION OF Surefire wood and combination furnaces. Save over \$600 on some models. Alternatives Tel: 264-6245.

ELGIN OATS for seed. Also quantity of good clover hay and cedar pickets apply W. Ross Elliot, Howick 825-2119.

INTERNATIONAL W-4 tractor International rubberers, 50 cw chains and tags, 1-200 gallon gas drum 1-200 gallon diesel drum. Tel: 264-3730.

PROPERTY FOR SALE

BRICK DUPLEX, 7 1/2 large rooms on each side can be converted easily into a home for elderly or other residential district with large wooded land, price to be discussed. Tel: 264-3682.

PERSONAL

PROVINCE OF QUEBEC MUNICIPALITE DE HINCHINBROOKE PUBLIC NOTICE

HOUSE KITS: All the building materials for a house 26 x 42, 3 bedrooms, bath, kitchen, dining and living rooms; 2 x 6 framing; 6 in. wood. For as low as \$10,895.00 tax incl. This price is firm till list of May. Blue prints available. Can also make prints to suit your needs. D.N. Racine Inc., Athelstan, Que., J0S 1A0. Tel: [514] 264-5533 or 3222.

ONE METAL dog crate 19x 38; one Yamaha motorcycle 100cc road bike. Just phone 247-3191.

1974 CAMARO, red, body work good, motor recently tuned, 4 new tires, need cash. No reasonable offer refused. Ask for John after 5 p.m. Tel: 825-2251.

PROPERTY FOR SALE

HOUSE LOCATED in Ste-Martine, Rang Touchette, small domain on 30,000 sq. ft. lot, main house 28 x 30, 1 1/2 stories, 7 rooms plus 2 rooms in basement, heated and insulated with fireplace, mature trees, waterfront, above-ground swimming pool. Also 3 small houses plus garage. Asking price \$58,000. By appointment after 5 p.m. and weekends. Tel: 427-2435.

WATERFRONT SUMMER cottage for month of July on Lake St. Francis or Chateaugay Lake, N.Y. area. Tel: 264-3305 or 264-6797 evenings.

PROVINCE OF QUEBEC MUNICIPALITE DE HINCHINBROOKE PUBLIC NOTICE

REFRIGERATORS - STOVES washers - dryers. Reconditioned, 30 day warranty. Ideal for home or cottage. W.D. Greig Inc., 57 Church, Ormstown. Tel: 829-2221.

BEE EQUIPMENT, new material. Tel: 829-3563 or 829-2286.

WOMEN'S CLOTHES sale, 49 Lampton Howick.

PROPERTY FOR SALE

1971 GMC mini van, 6 cycles, standard, very clean, A-1 mechanical order, Michelin tires, stereo \$1200 or to be discussed or would trade for 4-cylinder car. Tel: 264-4630.

TO EXCHANGE

HOWARD L. WELBURN Sec.-Treasurer

CANADA NO. 1 maple syrup, maple cream spread, maple candy and maple sugar. In standard and fancy containers. Stanley and Charles Reid 2294 Ridge Rd. Huntingdon. Tel: 264-3493 or 264-5176.

2 YEAR old filly, half Belgian, green broken to drive, to work. \$1,200 firm. 264-3191.

WOODSTOVE FOR sale, \$250. Call 829-3761 after 6 p.m. weekdays or all day on weekends.

PROPERTY FOR SALE

TO BUY OR EXCHANGE

TO EXCHANGE

HELP WANTED

1980 TRACTOR, Ford 4100, Allied loader, 180 hours \$11,500, evenings. Tel: 826-4690.

OVERNIGHT STEAMBOAT vacations - Canada's newest replica steamship - the elegant Canadiana Express. Calm-water cruising on the mighty St. Lawrence River through the heart of the most beautiful scenery in central Canada. Three to seven day cruises available. Contact your travel professional or Dial-A-Brochure toll free 1-800-267-0960 or collect 613-549-8091.

BABY GRAND piano 5 feet 3 inches, excellent \$3,500. Rockburn 264-6545.

PROPERTY FOR SALE

TO RENT

TO RENT

AUSTIN CHARTERS 264-2524

SCHOOL HOUSE, excellent condition 20 x 30 ft. must be moved. \$5,000. Rockburn Tel: 264-6545.

FIND GOLD, silver, coins, jewellery with "Whites" metal detectors from "Happy Jacks", \$129.95 up. Box 295 Strathroy, Ontario 1-519-245-1749. Free catalogue. Authorized Factory Distributor. Repair Centre. Dealers wanted.

PUT MORE pounds on your commercial beef with a purebred polled Hereford bull, Chateaugay Valley. Leading producer of Registered polled Hereford has two choice yearling bulls for sale. Also heifers and bull calves and bred cows available at all times. Prices are reasonable. Visitors welcome. Westwind Valley Farm, 247-2630.

PROPERTY FOR SALE

TO RENT

TO RENT

TO RENT

1/2 ARABIAN horses [3], Viceroy buggy, purebred Arabian stallion at stud. Tel: 514-264-3689.

STEEL FROM our factory. Manufacturer has all steel buildings at factory direct savings to you. Example: 40 wide x 60' long, regular price \$8,938, your price \$6,498. Complete with ends and huge steel door. Call toll-free 1-800-268-4942.

LOTS OF furniture and odds and ends all in good condition, stereo, stove, antique dining room set, etc. Tel: 829-2905.

PROPERTY FOR SALE

TO RENT

TO RENT

TO RENT

CEDAR CHEST made of oak by cabinet maker, ideal for wedding gift. Tel: 264-2014.

STEEL FROM our factory. Manufacturer has all steel buildings at factory direct savings to you. Example: 40 wide x 60' long, regular price \$8,938, your price \$6,498. Complete with ends and huge steel door. Call toll-free 1-800-268-4942.

WHO'LL BE the lucky one? 450 ft. of pine 2 x 6, rough in lengths of 8, 10, 12 and 14 feet. Price \$200 for the lot. 75 Cedar pickets, sharpened. Price to be discussed. Tel: 264-6484.

PROPERTY FOR SALE

TO RENT

TO RENT

TO RENT

HAY DELIVERED Tel: 264-5280.

1978 YAMAHA 175 road and trail, A-1 condition. Tel: 264-2550 after 7 p.m.

1976 BUICK Century station wagon, good condition. Tel: 264-4933 after 6 p.m.

PROPERTY FOR SALE

TO RENT

TO RENT

TO RENT

COMPLETE LINE OF BUILDING MATERIALS ELECTRICAL SUPPLIES PLUMBING HARDWARE

• HOUSE PLANS AVAILABLE •

• FREE ESTIMATES •

INTERIOR DECORATOR AND DESIGNER ON STAFF TO BETTER SERVE YOU.

D. N. RACINE INC. 264-5533 264-3222

ATHELSTAN, QUEBEC

STE-MARTINE: building to rent for nursery green house, horses, on 12 arpents lot. Tel: 825-2814.

FURNISHED 2 1/2 apartment, excellent for senior citizens. May 1st occupancy. For information call 264-6307.

SPACE TO rent for office or small store on Frontier St. in Hemmingford, Que. Call 247-2731 or 2967.

ALCOHOLICS ANONYMOUS

If you want to drink and can't that is your business. If you want to stop and can't, that's our business. For information call Montreal 773-7544. Weekly meeting: Thursday 8:30 p.m. St. James Anglican Church Hall, Ormstown, Friday 9 p.m. St. Joachim Church, Chateaugay Centre; Saturday 8:30 p.m. Presbyterian Church, Dufferin Street, Valleyfield.

MARILYN C. PARTRIDGE F.R.I. OFFICE: 264-4798 RESIDENCE: 264-3095

ORMSTOWN: Bungalow built 1976, 4 bedrooms, 2 bathrooms, finished basement, with fireplace, immaculate condition, quiet location, near the town. Keith Greig, 829-2419

ALCOHOLICS ANONYMOUS

If you want to drink and can't that is your business. If you want to stop and can't, that's our business. For information call Montreal 773-7544. Weekly meeting: Thursday 8:30 p.m. St. James Anglican Church Hall, Ormstown, Friday 9 p.m. St. Joachim Church, Chateaugay Centre; Saturday 8:30 p.m. Presbyterian Church, Dufferin Street, Valleyfield.

PROP. FOR SALE

Huntingdon, solid stone home, 13 rooms, 3 baths, ideal rooming house, plus private quarters included. L.R., DRK combination, 2 bedrooms, full bath, plus 2 piece washroom, full basement, large lot, double car garage, 30 day possession. Excellent terms. Priced to sell. Royal Trust Co. Longueuil Que. 463-3731 Franklin agent E.H. [Rick] Bown 827-2406.

HUNTINGDON-ORMSTOWN HOLSTEIN CLUB ANNUAL BARN MEETING SATURDAY, APRIL 16 1 p.m. AT FERME LEDUC & FRERES

Rang St-Georges St-Etienne-de-Beauharnois

Refreshments Door Prize

For inf.: Maurice Léger 264-2457 Jane Montpetit 373-5065 Fred Sunborg 829-2577 411 members welcome

PROVINCE OF QUEBEC MUNICIPALITY OF TOWNSHIP OF DUNDEE TO THE RATEPAYERS OF THE AFORESAID MUNICIPALITY PUBLIC NOTICE

is hereby given by the undersigned, Secretary-treasurer of the aforesaid municipality, that: The office of the undersigned is closed from April 11 till May 2, 1983 inclusive.

And that a receipt for all payments for municipal taxes sent by the post office will be sent to the ratepayers as soon as possible by the undersigned. Given at Ste-Agnes-de-Dundee this 9th day of April, 1983.

Beatrice Van Winden Secretary-Treasurer

le Permanent

ROCKBURN: Imagine a period house exposed beam decor, fireplace, stables, workshop, on 2 acres with tall pines, priced at \$57,000.

ELGIN LOYALIST: Stone house, original wood finishes, on 100 rolling acres of the best land and bush around.

HUNTINGDON: 220 acre farm 165 arable, the rest is in pasture and bush, renovated house, good barn and silo.

HUNTINGDON: 242 acres of arable land, plowed, some bush and pasture, good line of machinery, possible to build house.

FRANKLIN: 7 acres on a mountain stream with large trees, organic gardens, lovely home with 70 mile view, \$59,000.

HUNTINGDON: Just out of town, extraordinary brick bungalow on a well landscaped lot, garage, finished basement, 3 1/2 apartment.

FRANKLIN: 2 1/2 acres on route 209, nice view, solid 2 story house of stucco and fieldstone on a slab of cement, fireplace, etc.

ORMSTOWN OLD: Brick renovated house, facilities on one level, 2 bedrooms, electric & wood heating, ideal for older people.

PATRICK PIETRYKOWSKI 264-3480 363-7000

LE PERMANENT-COURTIER

le Permanent COURTIER YOUR AGENT L. BRASSARD 264-5679 or 264-5987

HUNTINGDON: 1978 bungalow on a large lot, dining room with patio door, oak floors, family room in basement, really clean. A pleasure to look at.

HUNTINGDON: Village, split level, large living room and kitchen, 4 large bedrooms, semi-finished basement, oversized garage, ideal for trucks, good location.

GODMANCHESTER: Split level, big living room and dining room, patio door pine wood work, finished basement, garage, paved entrance. Has to be seen.

ORMSTOWN [COUNTRY]: 1 mile from town, vinyl bungalow, 3 bedrooms, wall to wall carpet, full basement, paved entrance, on a good sized lot. Only \$24,500.

HUNTINGDON: 1976 Canadian cottage, kitchen with patio door, large living room with stone fireplace, mezzanine, heated garage, built on 45,800 sq. ft. of land. Barn, etc. \$64,900.

ST-ANICET: Brick winterized home with garage, finished basement on a large lot with 100' lake front, beautiful view, bathhouse, \$58,500.

HEMMINGFORD: 1975 bungalow, finished basement, 3.5 arpents, barn for horses, small training arena, tack room, etc.

le Permanent COURTIER YOUR AGENT L. BRASSARD 264-5679 or 264-5987

HUNTINGDON: 1978 bungalow on a large lot, dining room with patio door, oak floors, family room in basement, really clean. A pleasure to look at.

HUNTINGDON: Village, split level, large living room and kitchen, 4 large bedrooms, semi-finished basement, oversized garage, ideal for trucks, good location.

GODMANCHESTER: Split level, big living room and dining room, patio door pine wood work, finished basement, garage, paved entrance. Has to be seen.

ORMSTOWN [COUNTRY]: 1 mile from town, vinyl bungalow, 3 bedrooms, wall to wall carpet, full basement, paved entrance, on a good sized lot. Only \$24,500.

HUNTINGDON: 1976 Canadian cottage, kitchen with patio door, large living room with stone fireplace, mezzanine, heated garage, built on 45,800 sq. ft. of land. Barn, etc. \$64,900.

ST-ANICET: Brick winterized home with garage, finished basement on a large lot with 100' lake front, beautiful view, bathhouse, \$58,500.

HEMMINGFORD: 1975 bungalow, finished basement, 3.5 arpents, barn for horses, small training arena, tack room, etc.

SUNDAY BRUNCH
 "THE FAMILY'S MEETING PLACE"
 Serving 10:30 a.m. to 1:30 p.m.

PRICE 5.95 Canadian funds
 10% discount for senior citizens
 Child portion available

Noon "Bloody Mary's" \$1.25
HOTEL FLANAGAN
 Malone, N.Y. Tel: (518) 483-1400

SUNDAY BRUNCH
 12 KINDS OF SALADS
 Ham Cooked in Pineapple Juice &
 Pure Maple Syrup
 Beef and Kidney Pie \$6.95
 All you can eat
 Bring your own wine or beer
 Restaurant
AU SOLEIL LEVANT
 2344 Route 201, Ormstown 829-2784

MILITARY WHIST
MONDAY,
APRIL 18 8 P.M.
 Huntingdon
 Legion Hall
 Sponsored by C.V.A. for
 Mentally Retarded
 Please bring cards

GERALD MARLEAU & FILS
 ELECTRICAL CONTRACTOR
 RESIDENTIAL
 - COMMERCIAL - INDUSTRIAL
 FREE ESTIMATES
TEL: 373-0238
 ST. STANISLAS DE KOSTKA
 ELECTRIC HEATING

Gleaner ads work wonders

12.5%



ANTILLES AUTOMOBILES INC.
 449 CHEMIN LAROCQUE
 VALLEYFIELD
 TEL.: (514) 371-5563

"GREAT SOUNDS"
 Bilingual D.J.
**FOR YOUR DANCES,
 WEDDINGS OR PARTIES**
 EXPERIENCE THE ULTIMATE IN
 RECORDED MUSIC
BOOK NOW
FOR INFORMATION TEL: 827-2962

**ANNUAL MEETING OF
 THE HUNTINGDON CURLING CLUB**
APRIL 14, 1983
8:00 P.M.
IN THE CLUB ROOMS
ALL MEMBERS REQUESTED TO ATTEND
 Maurice Smith, Pres.
 T.W. Brooks, Sec.

ANNUAL MEETING
 Zion
 Church
 Cemetery Co.
WEDNESDAY,
APRIL 20 8 p.m.
 Home of Fred
 Armstrong, Dundee.

WALLACE KERR
GENERAL CARPENTRY
CONSTRUCTION AND RENOVATION
BARN, MACHINERY SHEDS AND
OTHER FARM BUILDINGS
TEL: 825-2713
HOWICK

NOTICE

Dr. Sonea's Hemmingford Veterinary Clinic will be closed from April 14th to April 18th, inclusively. For emergencies please call:
 For horses: Dr. Sylvie Surprenant 1-481-1285
 For pets: Drs. Marcell & Johnston 825-2349.
 My apologies for any inconvenience this may cause.

Dr. Sonea

FRONTIERE GRILL
 Trout River, N.Y.

NANCY & THE MIDNIGHT RIDERS
SATURDAY, APRIL 16
 9:30 to 1:30 a.m.

Hours: Mon to Thurs 10 a.m. to 1 a.m.
 Fri-Sat. 10 a.m. to 3 a.m.
 Sun. 12 noon to 3 a.m.

Come enjoy our 21 feet shuffleboard

**BRASSERIE
 LA DILIGENCE**
 Howick 825-2837

THURSDAY
"TALENT NIGHT"

**BRING YOUR OWN INSTRUMENT
 OR JUST YOURSELF ACCOMPANIED
 BY MAC PIEDIE AND DAVID WHITE**
FRIDAY AND SATURDAY
"ENTERTAINMENT"

SPRING FESTIVAL
**UNITED CHURCH
 HALL
 HEMMINGFORD**
APRIL 30
10 A.M. TO 4 P.M.

MIXED SHOWER
 in honor of
SANDRA LESLIE and PIERRE GENIER
SATURDAY NIGHT, APRIL 23

Chateau Dining Room
 Music & Lunch \$4.00 each

MOBILE SAW MILL SERVICE
 Custom Sawing
 At your wood lot or
 any place you choose

Maifred (Fred) Prueckel
 R.R. 3 P.O. Box 587
 Ormstown, Québec
 (514) 829-2611

CANDLELIGHT RESTAURANT & LOUNGE
 located 3 miles east of Ellenburg Depot, N.Y.
 will feature a

COUNTRY AND WESTERN JAMBOREE
SUNDAY, APRIL 17
FEATURING 5 TO 7 BANDS
 Along with the regular band of

"THE CLEM HAWKINS BAND"
STARTING 3 P.M.

SPECIAL DINNER SERVED EVERY SUNDAY FOR \$4. PER PERSON

RESERVATIONS ACCEPTED ANYTIME FOR ALL OCCASIONS
TEL: 518-594-7306

KNOTTY PINE RESTAURANT
 ROUTE 374 CHATEAUGAY LAKE, N.Y.

SATURDAY NIGHT & SUNDAY SPECIALS

SURF 'N' TURF \$12.95
 Includes 2 lobster tails plus steak

PRIME RIB OF BEEF \$8.95 \$7.25
 Regular Cut Strip Loin

ALL WITH VEGETABLE, POTATO, SALAD BAR, AND BREAD BAR

Open Sat. night at 5 p.m., Sun. at 1 p.m.

KNOTTY PINE WILL OPEN FOR PRIVATE PARTIES ANY DAY OF THE WEEK
TEL: 518-425-3481 483-1280 DAYS

RESERVE MAY 7
 Riverfield Curling Club
 Smorgasbord
 For tickets contact
 J. Craig 825-2074 \$7.50

NOW OPEN CLUB VIDEO ORMSTOWN
57A CHURCH ORMSTOWN
RENTAL OF VCR AND MOVIES BETA & VHS
ALSO COLECO GAME SYSTEM
OVER 150 MOVIES AVAILABLE

TELEVISION REPAIR

HITACHI Sales and Service
 Specialty COLOR

J.L. DANCAUSE T.V.
 St. Anicet Tel: 264-2565

ACADEMY AWARD WINNER
 The Best Picture of the Year
 Best Actor of the Year
 - Ben Kingsley
 Best Director

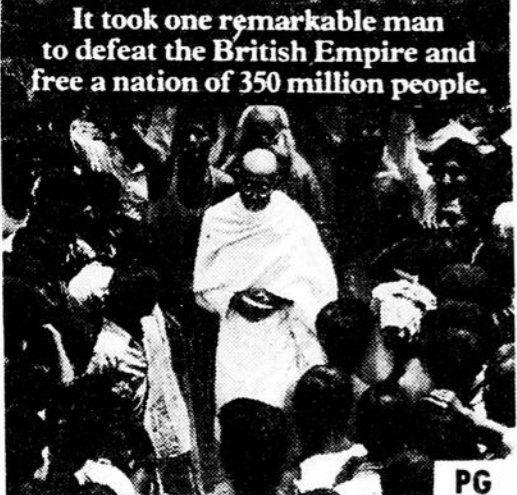

It took one remarkable man to defeat the British Empire and free a nation of 350 million people.

GANDHI
 His triumph changed the world forever.

CINEMA PLAZA MALONE, N.Y.

Fri thru Thurs - Gandhi is hrs 10 min. long - hence 1 show nightly at 7:30 - Sat-Sun matinees at 1:45.

Today & Thurs "Spring Break" 7:35

THE WESTERNER
 CHATEAUGAY, N.Y.

PROUDLY PRESENTS GRAND OLE OPRY STAR "JEAN SHEPPERD AND THE SECOND FIDDLERS"

Sunday, APRIL 24th
2 BIG SHOWS
1:30 & 6:30 P.M.
 (Your favorite drinks served at your table)

TICKETS ON SALE NOW, \$9.00 U.S.

PER PERSON PER SHOW AT MILL'S RESTAURANT & THE WESTERNER CORNER MAIN & DEPOT CHAT., N.Y.
 (518) 497-9989

COME IN EARLY AND HAVE FUN FOR MORE INFORMATION:
 (518) 497-6651 OR (518) 497-6541

AVON TURN EXTRA TIME INTO EXTRA MONEY
 Sell Avon. Great people. Earn \$\$\$.
 Set your own hours.
CALL 373-5555

SOCK IT TO ME
SOCKS FOR THE ENTIRE FAMILY CHEAPER BY THE DOZEN

"LA BOITE A SURPRISE"
111 CHATEAUGAY, HUNTINGDON

Tel. (514) 825-2499



Mike Hampton
 Horseshoer - Forgeron
 Graduate of Kemplville Farrier Program
 669 Scotch Concession, Howick, Que., J05 1G0

PHOTOGRAPHY
GENERAL - WEDDINGS - SPECIAL EVENTS
TEL: 825-2291
G. ROBERTSON

CLOTHING SALE TUESDAY & WEDNESDAY
APRIL 19-20
 9:00 a.m. to 5:00 p.m.
 St. Joseph's Parish Hall
 Huntingdon
 For the benefit of the Parish organized by the Ladies of Ste. Anne

DR. RENE BRISEBOIS
DENTAL - SURGEON
31 YORK ST. HUNTINGDON
TEL.: OFF. 264-3811, RES. 264-3048

LUNCHEON HUNTINGDON UNITED CHURCH
THURSDAY, APRIL 21
 12 and 1 p.m.
 Adults \$4.50
 Children 5-11 - \$2.50
 Under five - Free
 Phone Blanche Brooks for tickets
 264-3162

STE-AGNES DE DUNDEE SALVATION ARMY PICK UP
TUESDAY, APRIL 19
 Clothes, furniture, toys, books, etc.
 Please bring articles to
 The Community Hall in Ste-Agnes on
 April 19th 9 a.m. to 5 p.m.
 For more information Tel: 264-5853 or 4301

DR. PAUL TABAKMAN
DENTAL SURGEON
OFFICE HOURS
TUESDAY TO SATURDAY
9:30 A.M. TO 6 P.M.
BY APPOINTMENT

2718 Plaza 219
 Route 219
 Hemmingford Tel: 217-2920

DONALD E. SUTHERLAND
 Chartered Accountant
 41 Lambton Street
 Ormstown
 Tel: 829-2372
 or
 1-897-1343

BARBER SHOPPERS CONCERT
HEMMINGFORD ELEMENTARY SCHOOL
SATURDAY, APRIL 16
 8 p.m.
 Donation: Adults \$3.00
 Children \$2.00

RICHARD LEDUC, DENTIST
SCHEDULE STARTING MAY 1, 1983

CHATEAUGAY	HUNTINGDON
119c BOUL ANJOU (Access Canadian Tire) Mondays, Thursday, Fridays Also evenings & Saturdays 691-9993	31 YORK Wednesdays 264-3811

FARM FOR SALE

In Ste-Clothilde, county of Chateaugay, a vegetable farm of approximately 33.6 ha [83 acres] of which 10 ha [25 acres] more or less of organic soil are tillable and 9 ha [22 acres] of organic soil also to be improved, with 2 greenhouses and a machine shed. This farm is situated on the 3rd range, 2 km from Ste-Clothilde. For additional information please contact:

MR. ALFRED MOORE AT 371-1772

MORTIMER ROSS & CO. CHARTERED ACCOUNTANTS
 P.O. BOX 21
 ST-BASILE DE MONTARVILLE
 QUEBEC J0L 4P0

MOBILE OPERATOR JHP 2882

MADGE (514) 843 700 ST-BASILE (514) 853 2907 GREENFIELD PARK (514) 611 444

LULIC ALUMINUM

SALES AND INSTALLATION

DOORS, WINDOWS, STEEL, ALUMINUM & VINYL SIDING GUTTERS

FREE ESTIMATES
CALL COLLECT 514-681-6178

HOTEL ORMSTOWN

PROUDLY PRESENTS CONTINUOUS DANCERS MON. TO FRI.
 5 p.m. to 7 a.m.
 Upon request Dancers at your table

HAPPY HOUR 5 p.m. to 7 p.m.

BANDS Sat. Night Only

EVERYONE WELCOME

CONTINUES PRESENTING THE BEST LAZER BLADE

FEATURING WARNER BROS. RECORDING ARTIST GEOFF HUGHES
SATURDAY, APRIL 16 ONLY

IN ASSOCIATION WITH... brian pomiere productions inc.

NO COVER CHARGE

371-5215

Centre de location



ZTEC INC.
 RENT-ALL CENTRE

TOOLS AND EQUIPMENT OF ALL KINDS
RENTALS - SALES - SERVICE
 555 CHEMIN LAROCQUE, VALLEYFIELD

ANNONCES
CLASSEES
264-5364

la GAZETTE

TRAVAIL
D'IMPRIMERIE
DE TOUS GENRES
(ESTIMES GRATUITS)
'LE GLEANER'
TEL. 264-5364

LE GLEANER, HUNTINGDON, QUE. LA GAZETTE — LE 13 AVRIL 1983 — 15 PRIX 40c



Le Chanoine Georges Quenneville a béni le repas lors du dîner de fondation du Club Optimiste de St-Anicet.

Le Club Optimiste de St-Anicet voit le jour

Texte de Cyril Alary
St-Anicet - Le Club Optimiste de la municipalité de St-Anicet a vu officiellement le jour dimanche le 10 avril alors que le Gouverneur Alain Marceau remettait au président fondateur Normand Lavoie la Charte.
Cette journée sera gravée dans la mémoire des gens de St-Anicet car une nouvelle aventure au sein de la grande famille Optimiste démarrait.
Un total de quarante-deux hommes de St-Anicet et de sa région immédiate ont décidé hierement de se lancer dans cette nouvelle aventure, formant ainsi un Club Optimiste pour le bien-être de leur communauté.
Le Club Optimiste de Huntingdon a parrainé l'arrivée du nouveau Club à St-Anicet, et tous les

membres de Huntingdon étaient très fiers de la tournure des événements.
Le maître de cérémonie de cet événement majeur était Jean Beauchamp du Club Optimiste de Huntingdon. Et avant de déguster un somptueux repas, on a procédé à "la partie sérieuse" de cette journée.
Après avoir reçu la Charte du Gouverneur Alain Marceau, le premier président du Club Optimiste de St-Anicet, Normand Lavoie, a reçu le certificat d'affiliation. Ensuite, le Lieutenant-Gouverneur Jean-Marc Brisson a procédé au dévoilement de la bannière du Club Optimiste de St-Anicet.
Le président du Club de Huntingdon, Cyrille Riendeau, a présenté au

président Normand Lavoie le maillot et la cloche, symboles de la présidence, tout en le conseillant de les surveiller de très près car une coutume optimiste veut que les autres membres cachent ces deux précieux éléments faisant ainsi une blague au président.
Plusieurs présentations ont suivi, et le Chanoine Georges Quenneville, curé de la Paroisse de St-Anicet, a été invité à bénir le repas.
Cette journée s'est continuée à la suite du repas par diverses activités tels que les amendes honorables et les dons volontaires, les vœux et contributions des autres clubs, la présentation de cadeaux souvenirs et le mot du président Normand Lavoie.
Une danse a clôturé cet important jour pour le Club Optimiste de St-Anicet.



Le président du Club Optimiste de Huntingdon, Cyrille Riendeau, a remis au président Normand Lavoie de St-Anicet le maillot et la cloche.

Huntingdon-Valleyfield:

Les enseignants ont rejeté à 54% le rapport

Texte de Cyril Alary
Valleyfield - La semaine dernière, les enseignants des secteurs Huntingdon et Valleyfield affiliés au Syndicat de Champlain ont rejeté les données du rapport du conciliateur Désilets par un vote majoritaire de l'ordre de 54 pour cent.
Le représentant des secteurs, Robert Ferland, a précisé qu'au niveau de la Commission des enseignants des commissions scolaires, le vote avait été très serré. En effet, un total de 20 syndicats avaient favorisé l'acceptation du rapport Désilets, tandis que 24 disaient non.
"Au niveau des membres, avec une participation totale de 30,9%, aux assemblées, 10 550 enseignants acceptaient le rapport Désilets, et 10 257 le rejetaient", de dire Robert Ferland.
Même si les enseignants ont rejeté le contenu du rapport Désilets, les représentants syndicaux demandaient au gouvernement du Québec de mettre en application les

effets positifs de ce rapport tout en amendant ainsi les décrets pour la prochaine année scolaire de 1983-1984. Ensuite on demande au gouvernement de reprendre les négociations en vue des années 1984-1985 et 1985-1986.
"La raison pour une telle demande demeure dans le fait que le ministre Camille Laurin a dit qu'il était prêt à mettre en application le contenu du rapport Désilets si les enseignants acceptaient", de préciser Robert Ferland.
Au moment de l'entrevue avec M. Ferland, le gouvernement du Québec ne s'était aucunement prononcé sur cette demande. Toutefois, si on en juge les propos du premier ministre René Lévesque lors d'une rencontre à Longueuil lundi soir, il n'est absolument pas question de reprendre les négociations avec les enseignants.
D'ici la fin de la présente année scolaire, les enseignants ne débrayeront pas, mais, selon M. Ferland, ils ont hâte que l'année scolaire se ter-

mine. "Le monde (les enseignants) n'a plus le cœur à l'ouvrage", a-t-il dit.

sous" et que la qualité de l'enseignement ne semblait pas intéresser plus que cela les autorités gouvernementales. Ceci ne veut pas dire pour autant que, d'ici la fin de la présente année scolaire, il n'y aura pas de petits conflits. Selon Robert Ferland, il est certain que certains conflits surviendront autour du premier juin lors de la mise en disponibilité des professeurs et lors des choix de tâche pour la

• pas de débrayage d'ici la fin

Les moyens d'action que les enseignants utiliseront afin de continuer la lutte seront de faire des campagnes d'information démontrant que les négociations avec le gouvernement n'étaient qu'une affaire de "gros

prochaine année scolaire à la fin du mois de juin. L'année scolaire 1982-1983 aura été mouvementée sur toute la ligne, et même les prochains mois pourront connaître certaines perturbations dans le quotidien. La seule chose positive dans tout cela demeure le fait qu'il n'y aura pas de débrayages massifs.

Ville de Huntingdon:

Le conseil porte à l'étude les demandes de l'Office

Texte de Cyril Alary
Huntingdon - Devant les demandes constantes de l'Office de la langue française, le conseil de la Ville de Huntingdon a décidé de porter le tout encore à l'étude avant de prendre une décision.
Toutefois, on peut remarquer de plus en plus que le conseil ne veut réellement pas se lancer dans toute cette question, et même on peut conclure que le conseil ne semble guère apprécier les demandes de l'Office.

de Richard Bergeron, du Service de la promotion du français dans l'Administration, la Ville de Huntingdon a jusqu'au 31 décembre 1983 pour se conformer à la Charte de la langue française.
M. Bergeron, toujours selon cette lettre, demande à la Ville de Huntingdon un engagement formel par voie de résolution que d'ici la fin de l'année 1983 certaines corrections à sa situation linguistique soient faites.

Pour sa part, l'échevin Douglas Field, lors de la rencontre du 5 avril dernier, a tout simplement rétorqué à la lettre de l'Office que, pour lui, il n'était aucunement question d'utiliser seulement le français sur les inscriptions des camions à l'incendie.
Certains membres du conseil ont repris les grandes lignes d'un récent interview qu'accordait le ministre Gérard Godin, responsable de l'application de la Charte de la langue française. Alors, certains points étaient mis en doute par le ministre et laissaient croire que certains changements auraient lieu.
Selon cette récente lettre

sonnes morales établies au Québec, incluant les reçus qui leur sont remis pour taxes foncières ou d'autres affaires ou de quelque autre nature.
• d'afficher en français seulement;
• de remplacer par des indications "Sortie" les indications "Exit" à l'intérieur de chaque établissement appartenant à la Ville ou de propriété conjointe avec d'autres municipalités;
• d'apposer un modificateur également en français sur les extincteurs chimiques;
• remplacer par un document unilingue français le formulaire de chèque de paie, incluant la partie détachable servant d'état de revenu et de déductions;
• utiliser la langue française seulement, remplacée ou complétée le cas échéant, par des symboles ou des pictogrammes comme indications relatives à la signalisation routière (code de la route ou règlement municipal) la partie générique de la

dénomination d'une voie publique doit être affichée en français seulement.
En plus de ces corrections demandées, Richard Bergeron a demandé à la Ville de joindre à leur réponse la copie de la convention signée entre la municipalité et l'Office de la langue française en ce qui a trait à la connaissance appropriée du français de toute personne nommée, mutée ou transférée au sein de l'administration.
Pour le moment, le conseil de la Ville de Huntingdon a décidé de porter le tout à l'étude et on peut se demander jusqu'à quel point cette étude se continuera.
Les échanges entre les deux parties vont-ils bien? C'est une très bonne question... Et pour tenter de répondre, on peut dire que, dans le premier paragraphe de la lettre de M. Bergeron, ce dernier note: "Votre réponse à lettre de... me fut transmise pour attributions. Puisse-t-elle être l'occasion d'une reprise des échanges entre nous".

Un blessé

Texte de Cyril Alary
Très St-Sacrement - Un automobiliste a été blessé légèrement le 6 avril vers les 15 heures 45 dans un accident de la circulation sur la route 203 près de la rue Bridge au sein de la municipalité de la Paroisse Très St-Sacrement de Hawick.
Roual Bourdeau de St-Chrysostôme était au volant d'une Pontiac rouge '77. Il a été blessé légèrement et il a dû être conduit au Centre Hospitalier Barrie des services médicaux pour recevoir les premiers soins.
L'agent Pierre Lapointe du détachement de St-Martin de la Sûreté du Québec a fait les constatations d'usage.

La St-Jean à Huntingdon

Huntingdon - Autrefois connue sous le nom de Comité des Loisirs de Huntingdon, la fête nationale du Québec sera soulignée à Huntingdon par plusieurs activités et une des plus remarquées sera sans aucun doute un défilé de la St-Jean.
Cette journée de fête sera organisée par l'Association des bénévoles dynamiques,

autres membres du conseil ont repris les grandes lignes d'un récent interview qu'accordait le ministre Gérard Godin, responsable de l'application de la Charte de la langue française. Alors, certains points étaient mis en doute par le ministre et laissaient croire que certains changements auraient lieu.
Selon cette récente lettre

Soirée des lauréats de la Chambre de Commerce

Texte de Cyril Alary
Valleyfield - Le gala des Lauréats des Personnalités de la Chambre de Commerce de Valleyfield aura lieu samedi le 16 avril à compter de 19 heures 30 à la cafétéria de la Polyvalente Baie St-François de Valleyfield.
Luc Lapointe, président du comité organisateur de cet événement, a précisé, lors d'une conférence de presse la semaine dernière, que les lauréats des Personnalités se veulent une compétition qui, un peu à la manière des Mercuriales de la Chambre de Commerce du Québec, vise à consacrer l'excellence et

les performances des entreprises qui évoluent à Valleyfield et dans la région.
Lors de la soirée du 16, les grands gagnants seront connus, et il s'agit de la troisième année consécutive de ce prestigieux événement du mérite de l'entreprise locale et régionale.
Un total de 49 entreprises ont participé dans différentes disciplines ce qui porte les inscriptions totales à 116, selon le président Luc Lapointe.

Blessé à Ste-Clothilde

Texte de Cyril Alary
Ste-Clothilde - Un motocycliste a été blessé dans un accident de la circulation le 9 avril derniers vers les 15 heures 15 sur le rang Deux près de la route 205 à Ste-Clothilde.

Jean-Jacques Poupard de Longueuil a perdu le contrôle de sa moto Honda '77 dans une courbe. Il a été conduit au Centre Hospitalier Barrie Memorial d'Ormstown où il a été traité pour des blessures légères.



Vendredi dernier, on posait la clôture autour du terrain de tennis au complexe du Centre Civique de Huntingdon. Ce projet du Club Rotary de Huntingdon deviendra une réalité très prochainement.

Ville de Huntingdon:

Les danseuses nues ne seraient pas bienvenues

Texte de Cyril Alary
Huntingdon - Les danseuses nues ne seraient pas bienvenues dans les limites de la Ville de Huntingdon, on peut dire que ceci va également pour les danseurs portant le même costume.
Cette affirmation peut être notée suite à la présentation d'un avis de motion par l'échevin Douglas Field, responsable du comité de police, lors de la

rencontre régulière du conseil de la Ville de Huntingdon mardi le 5 avril dernier.
Un règlement sur cette question sera présenté lors d'une prochaine rencontre du conseil afin de statuer sur la présence des danseuses et danseurs nus dans des établissements tels que des bars et des hôtels.

Autour de la Ville de Huntingdon, on peut retrouver des danseuses nues dans des bars du Village d'Ormstown, de la Cité de Salaberry de Valleyfield, de Dorion et de Chateaugay.
Les amateurs de ce genre de spectacle nocturne devront tout simplement ne pas compter sur leur chance dans la Ville de Huntingdon, et devront aller à l'un des autres endroits se rincer l'œil.

Vous m'en direz tant!

par Cyril Alary



Ca me tracasse

Dans la vie de tous les jours, les gens réagissent différemment devant des situations, des faits ou des actions précises.

Il y a aussi des choses bien particulières qui nous affectent différemment, des gestes qui nous tracassent plus particulièrement.

Comme tout le monde, il y a des choses qui me troublent particulièrement, et même je devrais dire que ces situations me portent à perdre le contrôle.

En identifiant quelques-unes, je crois que plusieurs personnes pourront s'identifier à celles-ci, et même le tout pourrait vous faire réfléchir également sur certaines choses tracassantes.

En voici quelques exemples:

• ça me tracasse quand je suis à une caisse dans un magasin d'alimentation à Valleyfield pour payer un chocolat au lait de 69 cents, que la caissière commence à parler à l'autre personne devant moi, et ces deux se racontent ce qu'ils ont fait depuis les cinq ou dix dernières années;

• ça me tracasse quand je prends la peine de me trouver un pain le plus frais possible (car on n'en mange pas beaucoup) et quand j'arrive à la maison, je retrouve mon pain au fond du sac avec quatre litres de lait par-dessus;

• ça me tracasse quand je me lève le matin, qu'il y a eu une panne d'électricité durant la nuit, qu'aucune horloge dans la maison est à la bonne heure et que la batterie de ma montre-bracelet a décidé de lever les pattes;

• ça me tracasse quand je suis arrivé dans un restaurant le premier et que toutes les personnes qui sont entrées après moi sont servies avant moi;

• ça me tracasse quand je me lève le samedi matin et je regarde les numéros gagnants de la loterie, que je pense d'avoir gagné le gros lot, mais je m'aperçois que j'ai en main le billet de la semaine dernière;

• ça me tracasse quand quelqu'un me voit avec la caméra au cou et me demande si je prends des photos;

• ça me tracasse quand je me rends à un lieu de rencontre, et que cette dite rencontre a été annulée et a été remise à un autre moment, sans avertissement;

• ça me tracasse quand le téléphone sonne à une quinzaine de reprises durant la nuit, vers les 3 heures, et après m'être heurté sur le bord d'une porte je réponds et on m'annonce poliment qu'il s'agit d'un mauvais numéro;

• ça me tracasse d'arriver à l'auto le matin et trouver un pneu crevé, et ceci arrive toujours quand tu es pressé par le temps et que tu dois aller quelque part;

• ça me tracasse quand je reçois une enveloppe par la poste avec un document que j'attends depuis belle lurette mais le tout a été déchiré durant la transmission;

• ça me tracasse quand j'écouté mon émission préférée à la télé américaine, que le président Ronald Reagan apparaît dans le cadre d'un bulletin spécial pour dire à tout le monde que l'économie va mieux et que les Russes ne sont pas tellement gentils.

Ce sont certaines des choses qui me fâchent le plus et qui me tracassent au plus haut degré. Mais que voulez-vous, la vie est remplie de petites choses du genre, et sans ces ennuis le tout pourrait être vraiment ennuyant.

Dix ans déjà

texte de Cyril Alary

Longueuil - Afin de souligner d'une façon particulière le dixième anniversaire des Centres de Services Sociaux dans le Réseau des Affaires sociales du Québec, une importante campagne d'information sous le slogan "Notre expérience... ça peut servir..." se poursuivra durant toute l'année.

Toutefois, cette campagne prendra l'aspect le plus visuel possible entre le début du mois d'avril et le 7 mai prochain.

Toute la région du sud-ouest est présentement desservie par le Centre de Services Sociaux Richelieu dont le bureau chef se trouve au 201 Place Charles Lemoine à Longueuil. On y retrouve également des sous-bureaux au 41 chemin Larocque à Valleyfield, au 155 rue St-Jean Baptiste à Châteauguay et au 89 boulevard Don Quichotte à l'Île Perrot.

Le but essentiel de cette campagne d'information se veut un moyen d'informer le public en général et de le sensibiliser à la mission réelle des Centres de Services Sociaux et des clientèles desservies.

Une thématique bien spéciale a été mise de l'avant afin de vraiment mettre tout l'accent de cette campagne d'information. Cette thématique bien précise se résume ainsi: "Au cœur du Réseau des Affaires sociales, les C.S.S. prennent leur place en disant ce qu'ils font, à quels besoins ils répondent et à qui ils offrent leurs services".

Il va sans dire que la population de la région du sud-ouest entendra parler du Centre de Services Sociaux Richelieu dans les prochaines semaines.

L'aide apportée par le C.S.S. se résume à des parents avec des problèmes familiaux, des adultes ayant besoin d'assistance et d'aide, des jeunes ayant besoin de protection, des jeunes ayant commis des actes contraires aux lois, des enfants adoptés, des enfants placés en foyer d'accueil, et des personnes âgées ayant besoin d'une certaine assistance.

C'était seulement quelques exemples de l'aide apportée par les Centres de Services Sociaux à travers la belle province.

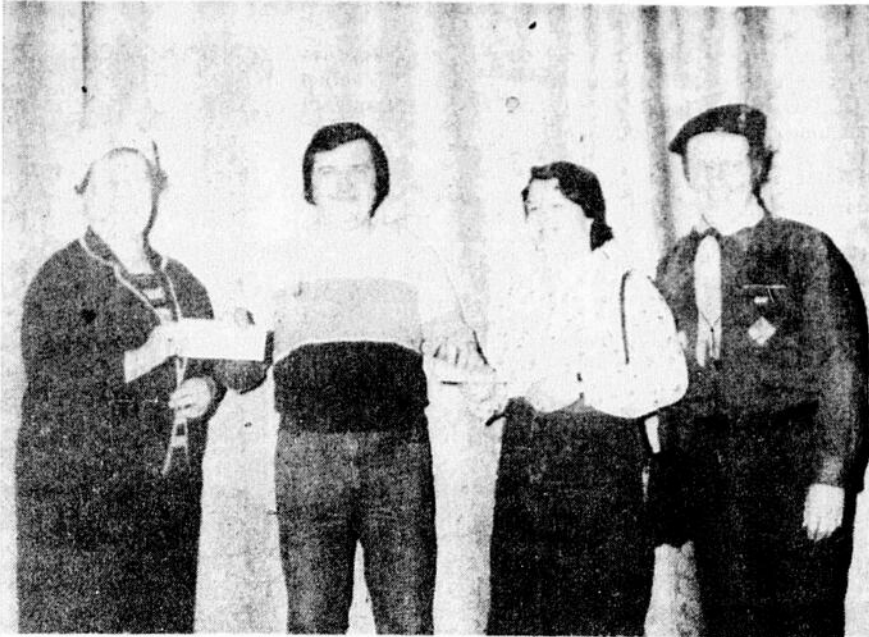

Dernièrement, le président du Comité de Loisirs de Huntingdon, Denis Yelle, (deuxième de la gauche) a remis des dons de 200\$ respectivement à Mme Evéline Leblanc de l'Age d'Or de Huntingdon et à Mme Gisèle Desrosiers du Cercle de Fermière de Huntingdon. En plus, un montant de 100\$ a été remis à Cecil O'Connor pour les Boy Scouts. Un montant de 100\$ a été remis au Mouvement Scout et Guide de Huntingdon mais personne n'était présent pour accepter le chèque.

Le Projet RIRE a reçu 54 jeunes depuis le début

Texte de Cyril Alary

Huntingdon - Un total de 54 jeunes de la région sont venus rencontrer les responsables du Projet RIRE à Huntingdon.

C'est en effet ce dont Laura Scott du Projet Ressource Information Ressource Entraide informait La Gazette la semaine dernière.

Expliquant que le Projet RIRE en était maintenant à sa deuxième phase, soit celle du regroupement, Laura Scott a dévoilé certaines statistiques sur les participants.

57 pour cent des jeunes qui ont rendu visite au

Projet sont francophones tandis que 43 pour cent sont anglophones. 54 pour cent sont des hommes et 46 pour cent des femmes.

Selon les groupes d'âge, 60 pour cent des visiteurs étaient âgés de moins de 20 ans, 25 pour cent de 20 à 25 ans et 15 pour cent de 25 ans et plus. Les jeunes provenaient à 60 pour cent de Huntingdon.

Des statistiques selon le degré de scolarité démontrent très bien la très grande diversité des jeunes visiteurs. Ces chiffres sont les suivants:

9% Secondaire II; 13%, Secondaire III; 25% Secondaire IV; 31%,

Secondaire V; 7%, Cegep; et 3%, université.

Toutes ces statistiques correspondent à la période des mois de février et de mars derniers.

Laura Scott a souligné également que le Projet RIRE offre aux jeunes la possibilité de passer un test d'orientation offert par un orienteur de Travail-Québec. On précise que ce test est gratuit.

Depuis le tout début du Projet, un total de dix jeunes ont passé ce test d'orientation.

En terminant, notons que le numéro de téléphone du Projet RIRE est le 264-6901.

Canton de Godmanchester:

Le conseil adresse certaines demandes

Huntingdon - Lors de sa rencontre régulière tenue le 4 avril dernier, le conseil de la municipalité du Canton de Godmanchester a décidé d'adresser quelques demandes au ministère des Transports du Québec.

La première demande faite au ministère des Transports du Québec concerne le fait de creuser un fossé sur le lot 56P sur une longueur de 420 pieds.

Le conseil a demandé également de faire nettoyer les fossés sur les lots 290 et 291P sur une longueur approximative de trois acres, propriété de Clayton Murphy. On veut également que le ministère remplisse une crevasse sur le chemin Ridge en face de la propriété de Réal Carrière.

Bill Martin a été nommé garde-feu pour l'année 1983 par le conseil de Godmanchester.

Les comptes suivants ont été approuvés par paiement: Salaires 4 331.32\$; Receveur Général, 385.48;

Ministère du Revenu, 463.46; M.R.C. Loyer avril, 150.00; Guy Provost, 1.695.83; Assurance La Mutuelle, 146.61; M.R.C. (photocopies), 40.48;

Richard Alary, 550.00; Equipements de bureau Valleyfield, 72.29; J.A. Thompson, 26.71; Bell Canada (bureau), 42.46;

Hydro Québec (éclairage de rues), 708.19; M.R.C. (bureau d'évaluation), 2.978.00;

Station feu: Bell Canada, 26.33; Bell Canada (appels d'urgence), 17.55; Hydro Québec, 409.68; Pierre Thibault (échelle), 1.266.51; Aéro Feu Ltée,

217.46; Garage Welburn, 40.30; William H. Martin, 30.22; Royce Ruddock, 38.11; Rolfe & Son, 6.22; Huntingdon Auto Parts Inc. 44.89; Renouvellement de licence de station Radio, 50.00;

Garage: Bell Canada, 12.75; U.A.P. 168.95; Centre de location Aztec Inc. 54.50; Acier Valleyfield Inc. 22.93; W.E. Lefebvre, 14.09; Garage Welburn 94.00; Unipar Inc., 89.31; Serge Dupuis (service de rétrocaieuse), 96.00

Salon Funéraire KELLY
Funeral Home
Reg'd
GORDON MCINTYRE
Propriétaire
DIRECTEUR DE FUNÉRAILLES
264-5447 - 264-5402
HUNTINGDON, QUE.

Salon Funéraire MONTPETIT
RODRIGUE MONTPETIT
Propriétaire
Directeur de funérailles
170 rue Châteauguay
Huntingdon
Incineration
Pre-Arrangements
Tél. 264-5021
Rés. d'été 371-0699

Ligue de Balle-Lente de Huntingdon: Le site du futur terrain devra être dézonné

texte de Cyril Alary

Huntingdon - Lors de la rencontre du 5 avril, le président, Laurent Cartier de la Ligue de Balle-Lente de Huntingdon s'est présenté devant le conseil de la Ville de Huntingdon afin de demander le dézonnage du terrain du dépotoir.

On se souvient que la Ligue de Balle-Lente avait signé dernièrement une entente notariée avec la Ville concernant la location pour une période de dix années du terrain du dépotoir fermé sur le chemin de Planche.

A cet endroit, la Ligue désire aménager un terrain de balle-lente afin de permettre aux formations de Huntingdon d'évoluer dans ce circuit.

Or il appert que ce terrain est présentement zoné agricole, et c'est pourquoi le président Laurent Cartier demande au conseil de la Ville de faire tout afin de remédier à cela.

Dans le cadre du programme fédéral RELAIS la Ligue de Balle-Lente a obtenu une subvention d'ordre de 11 845\$ permettant la création de trois emplois. Le but de ce projet est précisément

d'aménager un terrain de balle-lente sur l'ancien dépotoir de la Ville.

Au moment de la rencontre, le conseil ne pouvait pas dire si une demande de dézonnage était nécessaire dans ce cas bien précis. Tout de même, l'échevin Georges Lazure a proposé qu'au besoin les démarches soient entreprises afin de changer le caractère agricole de ce terrain à un d'ordre récréatif seulement.

Et le lendemain, des démarches furent entreprises dans ce sens, et ce après avoir fait les vérifications nécessaires. On espère que le tout sera fait assez rapidement afin de permettre que les travaux d'aménagement du terrain puissent débuter dès le 2 mai prochain.

Nouvelles de la Ligue: Un total de sept formations participeront aux activités de la Ligue cette année. Ces formations sont les suivantes: Ste-Barbe; St-Anicet; Cazaville; H. Legault & Fils; VD Fondation; Toyota; et une autre équipe dont le nom n'est pas encore connu.

On sait que Laurent

Cartier est le président de la Ligue, mais voici maintenant les autres membres du bureau de

direction: Emile Hart, Greg Brunette et Achille Provost, tous trois vice-présidents; Gaétan Roy au poste de secrétaire-trésorier; et les directeurs Howard Welburn, Guy Clermont et Pierre Daoust.

Donc, on peut voir vraiment que la Ligue de Balle-Lente est bel et bien en vie.

Les femmes et la carrière d'assureur-vie

Au travail égal, salaire égal, dit-on. En principe, tout le monde est d'accord sur la «libération économique» de la femme. Cependant, en dépit de toute la publicité verbale et des nombreuses législations venant appuyer ce mouvement, il n'en reste pas moins qu'en fait, le salaire moyen des femmes est loin d'équivaloir en termes de revenu celui d'un homme pour un travail identique.

Comment une femme peut-elle remédier à cette situation si sa propre libération économique est concernée? En travaillant dans un domaine où on ne retrouve pas seulement un salaire égal mais aussi des chances égales.

À ce chapitre, un des domaines les plus ouverts aux femmes est la carrière d'assureur-vie. Je n'ai encore jamais vu un contrat de travail d'un agent qui stipulât que l'échelle de commission différerait selon qu'il s'agissait d'un homme ou d'une femme. Du point de vue d'une compagnie d'assurances, une police vendue est une police vendue, indépendamment du sexe, de la race ou de la couleur de l'agent qui l'a vendue. Voilà une chance d'obtenir des revenus égaux pour un travail égal et ces femmes gagnent souvent plus que bien des médecins, avocats ou autres.

Il n'y a pas de limite aux revenus qu'une femme peut gagner en assurance-vie. Si elle découvre un marché intéressant, acquiert les connaissances et développe les habiletés pour desservir ce marché, avec de la volonté et de l'intelligence, elle peut atteindre un niveau de «libération économique» qu'elle n'aurait jamais pu imaginer.

CHEZ CENTRE-JARDIN ST-ANICET ENRG. POUR DE LA QUALITE ET DE BONS PRIX:

VOUS TROUVEREZ:

- ARBRES
- ARBUSTES
- CONIFERES
- PLANTES VIVACES ET ANNUELLES
- PLANTS DE LEGUMES ET FINES HERBES
- SEMENCES
- TERREAU
- HERBICIDES
- INSECTICIDES
- ENGRAIS
- POTS DECORATIFS
- OUTILS DE JARDINAGE ETC....

NOUS VOUS OFFRONS AUSSI UN SERVICE PAYSAGER (PLANTATION ET ENTRETIEN)

POUR QUE VOTRE PRINTEMPS COMMENCE EN BEAUTE



VENEZ CHEZ CENTRE JARDIN ST-ANICET ENRG.

1047 ROUTE 132, ST-ANICET JOS 1M0

264-6861 264-4140 (SOIR)

LISE ET MARC WART

C'EST DU VOL!



MAINTENANT... NOUS RÉDUISONS LES PRIX DE \$9 000 AU MAXIMUM SUR LES TRACTEURS MF NEUFS

Comme Massey-Ferguson nous accordons de gros escomptes d'usine sur la plupart des tracteurs MF neufs modèle 1982 (de 34 cv et plus) de notre stock, nous pouvons vous faire profiter de grosses économies, qu'il s'agisse des gros

tracteurs série 2000 ou des tracteurs utilitaires. Nous avons plusieurs options d'achat à vous offrir, même sur les tracteurs usagés. Nous sommes prêts à vous les expliquer!

VENEZ VITE SAISIR VOTRE AUBAINE!

C'est permis de nous "voler" jusqu'au 29 avril 1983.

NOUS AVONS MANTES OPTIONS!



Offres limitées au stock disponible.

LA CIE LONGTIN INC.

ST-STANISLAS DE KOSTKA

514) 373-0717

Pédigrain Inc.

VOS DEPOSITAIRES

LEONARD LEBLANC

264-2119

6034 RIDGE

STE-AGNES

POUR STE-AGNES - ST-ANICET - ELGIN - HUNTINGDON

RAYMOND LANIEL

264-4524

LOST NATION

HUNTINGDON

POUR ATHELSTAN - HINCHINBROOKE - HOWICK - ORMSTOWN - HUNTINGDON

VARIETE COMPLETE DISPONIBLE

- CEREALE PUR OU EN MELANGE
- FOURRAGERE PUR OU EN MELANGE
- SOYA • MAIS ASGROW • HERBICIDES • PESTICIDES

BATIMENTS ET ENTREPOTS

BELHEN - WICKES

COMMANDEZ TOT POUR UN MEILLEUR SERVICE

Tout un tournoi de hockey

Le gardien Luc Ricard et le centre Jean-Paul Mainville (au centre) ont été proclamés les meilleurs joueurs et ont été félicités par Jean-Paul Duplessis et Marcel Bégin.

Les formations qui se sont mérité les honneurs de ce tournoi ont été les suivantes:

- dans la classe BB: les Rouges des Usines Huntingdon ont remporté une victoire sur les Bisons des Fragiles par le pointage de 3 à 2 en supplémentaire. Le vice-président des Fragiles, Ernest Beaudry, a présenté au capitaine René Lefebvre le trophée de la victoire, tandis que Jacques Hurteau remettait le trophée Molson à l'instructeur Yvan Chartrand.
- dans la classe AB: la

formation Midget de l'Association du hockey mineur de Huntingdon a défait les professeurs de l'école CVR par le pointage de 5 à 2. Le trophée de la victoire a été présenté par Jacques Hurteau au capitaine Marion Pivin; le trophée Molson a été remis à l'instructeur Marcel Perras par Clermont Laurendeau. Luc Perras et Joël Bergevin, tous deux du Midget, ont été proclamés respectivement les joueurs offensif et défensif.

en quelque sorte une reprise de la finale de la Ligue de Hockey du Dimanche Matin alors que les Renegades et les North Stars s'affrontaient. Les Renegades ont remporté à nouveau la victoire en humiliant les North Stars par le pointage de 9 à 3. Le capitaine Jim Blair a reçu le trophée de la victoire de même que le trophée Molson.

les joueurs défensif et offensif de la joute. Il faut noter que des centaines et des centaines de spectateurs se sont entassés à la Patinoire Régionale afin d'assister à ce tournoi de hockey des plus intéressants. L'action n'a surtout pas manqué, et tous les matches présentaient vraiment tous les aspects de la compétition active.

Soirée importante pour la Fondation

Le gardien Luc Ricard et le centre Jean-Paul Mainville (au centre) ont été proclamés les meilleurs joueurs et ont été félicités par Jean-Paul Duplessis et Marcel Bégin.

économique, d'urgence à court terme, et par le fait même viser à l'apport de solutions collectives permanentes si nécessaires, le tout afin d'en arriver à la prise en charge de la communauté par elle-même face aux problèmes qu'elle vit collectivement.

La table de concertation-famille dans la région qui regroupe plusieurs personnes de différents niveaux en était venu à la conclusion de la nécessité d'une telle Fondation après avoir étudié maints rapports socio-économiques sur la région de Huntingdon.

Donc, ce soir marquera une étape très importante de la petite histoire de la Fondation Ressource-Action de Huntingdon.

Succès de l'Opération Impôt à l'ADD

Le gardien Luc Ricard et le centre Jean-Paul Mainville ont été proclamés respectivement

que d'autres sessions dans le cadre de l'Opération Impôt auront lieu durant la semaine des Assistés Sociaux prévue pour le 24 avril au 30 avril. Les intéressés sont priés de prendre note de cela, et de surveiller la programmation de cette semaine quelque peu spéciale pour avoir tous les coordonnées des sessions d'impôts.

Le service gratuit semble être très populaire, et veut dire également que le tout est vraiment une nécessité.



"Où est donc la rondelle", semble dire le gardien de but sur cette scène. Cette scène démontre très bien le jeu enlevant.



Le gardien Luc Ricard et le centre Jean-Paul Mainville (au centre) ont été proclamés les meilleurs joueurs et ont été félicités par Jean-Paul Duplessis et Marcel Bégin.



La formation des Rouges des Usines Huntingdon a été par les Fragiles. L'une des équipes gagnantes lors du tournoi organisé

A St-Chrysostôme: Suite à un argument, il reçoit une balle dans le dos

Le gardien Luc Ricard et le centre Jean-Paul Mainville (au centre) ont été proclamés les meilleurs joueurs et ont été félicités par Jean-Paul Duplessis et Marcel Bégin.

St-Chrysostôme - Un homme âgé de 67 ans a reçu une balle dans le dos suite à un argument avec sa femme à leur domicile de la route 203 à St-Chrysostôme.

En effet, ce drame s'est produit vers les 8 heures le matin du mardi 29 mars dernier. Alors, suite à un argument, Sarto Gervais a été tiré dans le dos par son épouse Emma.

Sarto Gervais a été conduit d'urgence au Centre Hospitalier Barrie Memorial d'Ormstown où il a dû être opéré immédiatement afin d'extraire une balle.

L'arme utilisée dans ce drame familial serait un revolver de calibre 22.

L'enquête policière a été immédiatement menée par l'agent Robert Longpré du détachement de Ste-Martine de la Sûreté du Québec en étroite collaboration avec l'Unité des crimes contre la personne de la Sûreté du Québec à Montréal.

M. Gervais a reçu une blessure superficielle, et, semble-t-il, sa vie n'a jamais été en danger. Son état est maintenant satisfaisant.

Il va sans dire que l'enquête policière se continue dans cette affaire.

et si le prochain visiteur...

Êtes-vous couvert ?

Les enfants laissent-ils souvent trainer des choses ? La neige et la glace s'accumulent-elles sur vos escaliers extérieurs ? Un vieux balcon qui pourrait par dessus alors qu'on le croyait sûr ?

Et si quelqu'un se blessait ? Si le livreur de journaux glissait dans votre escalier ? Si une marche cédait au passage du facteur ? Et si un ami trébuchait sur un jouet des enfants ?

Vous pourriez être tenu responsable même si vous ne pensez pas l'être.

Un voisin, un ami et même un parent qui subit des dommages corporels ou matériels à la suite d'une chute ou d'un accident survenu chez vous a légalement le droit de vous poursuivre. C'est pour cette raison que votre courtier, votre assureur et le Bureau d'assurance du Canada vous suggèrent de prendre l'assurance de la responsabilité civile qui accompagne l'assurance habitation proprement dite. Elle est



indispensable et ne représente qu'un pourcentage minime de votre prime.

Saviez-vous que la victime d'un accident survenu chez vous peut vous poursuivre pour des milliers de dollars pour la simple perte d'un doigt par exemple, ou encore pour des centaines de milliers de dollars en cas d'invalidité dite grave ou prolongée ?

C'est pour cette raison que votre courtier, votre assureur et le Bureau d'assurance du Canada vous conseillent de souscrire une

assurance de la responsabilité civile assez élevée pour vous mettre à l'abri de toutes éventuelles poursuites.

L'ASSURANCE DE LA RESPONSABILITÉ CIVILE, au cas où le malheur frapperait...

Le BAC met à votre disposition une série de dépliants et de brochures qui répondent à toutes vos questions en matière d'assurance habitation.

Remplissez le coupon ci-joint et recevez gratuitement toutes les réponses à vos questions.

question d'assurance habitation ?

- L'assurance habitation : Questions et réponses
- Une prime d'assurance ça se contrôle
- L'inventaire de vos biens meubles
- Guide pratique de l'évaluation des maisons
- Pour faire assurer vos objets de valeur
- L'inflation et le coût des réparations aux habitations
- Soixante façons de prévenir l'incendie
- Les poêles à bois et à charbon : Quelques règles de sécurité
- Alerte à l'incendiaire
- Le BAC, Bureau d'assurance du Canada

Je desirerais obtenir gratuitement, sans aucune obligation de ma part, le(s) document(s) suivant(s) :

Propriétaire Locataire

Faites parvenir ce coupon à l'adresse qui suit :



Bureau d'assurance du Canada
Boite Postale 360, Succursale S
Montréal (Qué.) H4E 4J8

NOM

ADRESSE

VILLE

PROVINCE

CODE POSTAL



SEMENCES DE MARQUE

PIONEER

MAIS DE SEMENCE DISPONIBLE
2200 A 2900 UNITES THERMIQUES

CROISEMENT TRIPLE OU SIMPLE

- GRAINES FOURRAGERES • SORGHO-HERBE DU SOUDAN
- INOCULANT D'ENSILAGE SILA BAC
- RENDEMENT ELEVE • MEILLEUR ENSILAGE

VOTRE DEPOSITAIRE POUR

STE-AGNES • ST-ANICET • HUNTINGDON • ELGIN

VOYEZ

LEONARD LEBLANC

264-2119

6043 RIDGE

STE-AGNES DE DUNDEE



3è rotation de Katimavik

Les jeunes de la troisième et dernière rotation du projet Katimavik à Huntingdon sont arrivés et ils travailleront à la Patinoire Régionale de Huntingdon et à la bibliothèque de l'École Polyvalente Arthur Pligeon. Les participants, cette fois, sont Rosie Fabigen de

Calgary en Alberta, Brenda Lewis de Queens en Ontario, Jake Leavitt de Samcoe en Ontario, Rob Fraser de Vancouver en Colombie-Britannique, l'agent de groupe Jean Corbeil, et Robin Rivest de Crabtree au Québec.

13 200 personnes appuient la demande d'un centre de dialyse

Un texte de Cyril Alary Valleyfield - Une pétition regroupant un total de 13 200 signatures de personnes provenant de tous les coins du sud-ouest demandant qu'une clinique de néphrologie et qu'un centre de dialyse soient ouverts au Centre Hospitalier de Valleyfield a été officiellement remise au directeur Jean-Guy Nadeau de cet établissement en présence du député Laurent Lavigne.

Dans l'espace d'un mois seulement, toutes ces signatures ont été recueillies par différents membres et bénévoles de la Fondation des maladies du rein, section Salaberry. Un mois pour accomplir cela, c'est tout un exploit, et Guy Beauchamp, souffrant lui-même d'insuffisance rénale, a tenu à préciser que ce fut un effort grandiose dont l'objectif premier était de recueillir 10 000 signatures. "Cette pétition n'était pas une contestation. Loin de là. Elle avait pour unique but de demander avec instance qu'une clinique de néphrologie et qu'un centre de dialyse soient ouverts au Centre Hospitalier de Valleyfield", de dire Guy Beauchamp.

Il a continué en précisant que la Section Salaberry tient à remercier très chaleureusement les bénévoles qui ont pris en main la pétition ainsi que la population qui a répondu massivement.

"Si le Centre Hospitalier de Valleyfield se veut une institution à l'écoute des

gens, s'il veut que la population s'implique, voici un vœu très net exprimé par ces milliers de gens. 13 200 personnes ne peuvent pas se tromper en même temps. On ne peut exprimer plus clairement un tel désir", de préciser Guy Beauchamp.

Ce dernier a ensuite voulu expliquer qu'une personne souffrant d'insuffisance rénale c'est quelqu'un dont les reins ne fonctionnent plus ou à un pourcentage très faible. Les reins sont des organes vitaux dont le rôle est de purifier le sang. Si la fonction s'arrête ou diminue, les déchets de l'organisme s'accumulent dans le sang et causent la mort par intoxication. Pour pallier à cette carence, la personne doit faire purifier son sang par un traitement avec un rein artificiel qu'on appelle "hémodialyse".

"La situation actuelle oblige le malade à se déplacer vers les hôpitaux de Montréal deux à trois fois par semaine pour subir ces traitements d'une durée de trois à six heures", a souligné Guy Beauchamp. C'est pourquoi il est important d'éviter ce trajet et de traiter les personnes

souffrant d'insuffisance rénale ici même dans la région.

Le directeur général Jean-Guy Nadeau a donné son entier appui à cette demande, soulignant également que l'installation d'un tel centre de dialyse au Centre Hospitalier de Valleyfield était déjà inscrite dans le cadre des priorités du Conseil régional de la santé et des services sociaux de la Montérégie. Pour sa part, le député péquiste Laurent Lavigne a tenu à souligner qu'il fera tout en son possible afin de faire avancer le dossier au sein du ministère des Affaires sociales du Québec. Il a noté avoir eu certains entretiens déjà avec le ministre Pierre-Marc Johnson sur le sujet.

Le processus permettant la réalisation d'un tel centre dans la région de Valleyfield en demeure un de longue durée. Déjà, certaines étapes ont été

prises en compte, et d'ici un an le tout pourrait être en



Une pétition de 13 200 signatures réclamant un centre de dialyse pour la région a été remis par Guy Beauchamp (à gauche) au directeur Jean-Guy Nadeau du Centre Hospitalier de Valleyfield, et par Lucie Loyer, directrice, au député Laurent Lavigne.

Une dame de Franklin impliquée dans un accident

Texte de Cyril Alary Ste-Martine - Une collision entre deux automobiles s'est déroulée

à l'intersection de la route 138 et de la rue Station, tout près du stationnement de l'Hôtel Jeanneau à Ste-

Martine. Le tout s'est produit vers les 20 heures 05 le 8 avril dernier alors qu'une automobile tentait de tourner dans le stationnement de cet hôtel et

venait ainsi en collision avec une autre auto. Les personnes impliquées dans cet accident ont été Sylvie Huneault de Beauharnois au volant d'une Chevrolet '74, et

Isabella Sutton de Franklin Centre dans une Datsun '82. Seule la Datsun a subi des dommages de 250\$. L'agent Pierre Lapointe du détachement de Ste-Martine de la Sûreté du Québec s'est rendu sur les lieux afin de faire le rapport d'accident.

Ormstown: Trois autos endommagées

Texte de Cyril Alary Ormstown - Trois automobiles stationnées dans l'aire réservée à cette fin au Centre d'Accueil d'Ormstown, le 30 mars dernier, ont été endommagées.

Ces trois actes de vandalisme auraient été probablement commis entre 20 et 23 heures avec l'aide d'un certain objet pointu.

Les autos endommagées étaient la Ford '79 de Claude Primeau d'Orm-

stown, la Lada 81 de Jeannette Laniel de St-Anicet et la Chevrolet Nova '78 d'Anne-Marie Bourdeau de St-Antoine Abbé.

Des égratignures assez prononcées ont été faites sur les trois automobiles, causant ainsi des dommages de 500\$ à chacune d'elles.

L'enquête dans cette affaire a été confiée à l'agent Michel Hébert du détachement de Ste-Martine de la Sûreté du Québec.

place si les fonds nécessaires étaient accordés par le ministère des Affaires sociales du Québec.

La Section Salaberry de la Fondation des maladies du rein a tenu à s'engager, par

la voix de Guy Beauchamp, d'être présente dans ce projet. Si un centre était accordé, la Section travaillerait fort au niveau de l'humanisation et de l'animation du centre, surtout en voulant améliorer la qualité de vie des patients.

AVON
TRANSFORMEZ
VOTRE TEMPS LIBRE
EN ARGENT
 Venez des produits Avon. Des gens sympathiques. Gagnez des \$\$\$ Fixez vos propres heures.
TEL: 373-5555

GAETAN MYRE
REFRIGÉRATION
APPAREILS
DE MAISON
REPARATIONS
264-3272

Canada
 Province de Québec
 District de Beauharnois
COUR SUPERIEURE
 No. 760-04-120-833
BERNICE HARRIGAN,
 domiciliée et résidant 49
 Poirier à Huntingdon
 Québec J0S 1H0, district
 de Beauharnois
 Partie demanderesse
 vs
GILLES BENOIT,
 anciennement domicilié
 à Huntingdon et
 maintenant résidant
 quelque part en Floride
 Partie défenderesse
 Ordonnance
 La partie défenderesse
 est par les présentes
 requis de comparaître
 dans un délai de trente
 (30) jours à compter de
 la publication. Une
 copie en français dans:
 "LA GAZETTE". Une
 copie de la déclaration a
 été laissée au greffe de
 la Cour Supérieure à son
 intention.
 Bureau du Protonotaire,
 Le 5 avril, 1983

CUSTOM MUFFLER
 Plus qu'un atelier de silencieux!
 • silencieux • balancement
 • amortisseurs • ressorts
 • alignement • pneus Michelin
 FREINS GARANTIS A VIE
260 boul. Mgr Langlois, Valleyfield 371-4281

TEL: (514) 264-5251
 RES: 371-5644
Dr. YVAN PERREAULT
 DENTISTE
 HEURES DE BUREAU
 LUNDI AU VENDREDI: 8:30 A 17:30
 LUN. - MER.: 18:30 A 21 HRES.
 SAMEDI: 8:30 A MIDI
 79 RUE WELLINGTON HUNTINGDON
 C.P. 1656 J0S 1H0

RECUPERATION DES ANIMAUX MORTS
 CHEVAUX - VACHES - VEAUX - PORCS, ETC.
 APPELEZ A FRAIS VIRES: 454-9434 ou 454-3274
 NOUVELLE ADMINISTRATION
 JEAN-MARIE LEFRANCOIS-ENTREPRISES INC.
 CHRISTIAN OU JEAN-MARIE
 NOUS PAYONS
 ET RAMASSONS ANIMAUX MORTS OU VIVANTS AUX MEILLEURS PRIX
 7 JOURS PAR SEMAINE SERVICE RAPIDE
 43, RUE STE-THERESE, ST-REMI

CONSTRUCTION MAURICE PERREAULT
 CONTRACTEUR
 CONSTRUCTION RESIDENTIELLE ET COMMERCIALE
 RENOVATIONS REPARATIONS
 TEL: 264-2970, 373-6779
 HUNTINGDON

ANDRE RADIO - TV ENR
 DEPOSITAIRE QUASAR
5 ANS DE GARANTIE SUR PIÈCES & MAIN-D'OEUVRE
INSTALLATION DE TOUR & ANTENNE
264-3741
2010 RIDGE RD. HUNTINGDON

THEORET
A. THEORET & FILS INC.
373-4408
RÉCUPÉRATION D'ANIMAUX MORTS
 chevaux-vaches-veaux-porcs-etc... 429-
 Pour meilleur prix 6613
 Appelez promptement à frais vires
RÉCUPÉRATION ST-ÉTIENNE ENR.
 840 Rg St-André St-Etienne-de-Beauharnois
 Ramassage 7 jours par semaine

POUR VOTRE RAPPORT D'IMPOT SUR LE REVENU
 • DECLARATION • PREPARATION
ROBERT SAUVE, B.A.,
 ETUDES COMMERCIALES SUPERIEURES MEMBRE DE LA SOCIÉTÉ INTERNATIONALE DES COMPTABLES INC.
TEL: 373-2510
OUVERT TOUS LES JOURS ET TOUS LES SOIRS
57 RUE NICHOLSON VALLEYFIELD

Venez vous sucrer le bec!

 "UNE CABANE A SUCRE UNIQUE"
 (RESERVEZ VOTRE JOURNEE MAINTENANT)
LE RELAIS SAINT-URBAIN
 COMMODITES POUR GROUPES
 500 RIVIERE DES FEVES SUD, ST-URBAIN
427-3550 427-5333

ACCORDAGE DE PIANO
 REPARATION & RESTORATION
 Tel: 829-2931 ou 3517
AARON BOUSEL
PATIENCE BOUSEL
ORMSTOWN

DENTISTE RICHARD LEDUC
HORAIRE 1er MAI 1983
CHATEAUGUAY HUNTINGDON
119c ANJOU BLVD 31 YORK
 (face au Canadian Tire) mercredi
 undi, jeudi, vendredi aussi soirs et samedi
691-9993 264-3811

VENTE DE LINGE
MARDI & MERCREDI
LES 19-20 AVRIL
 9h a.m. à 5h p.m.
SALLE PAROISSIALE ST-JOSEPH,
 Huntingdon
 au Profit de la Fabrique
 Organisée par les
 Dames de Ste-Anne

CLUB HOLSTEIN HUNTINGDON-ORMSTOWN
REUNION ANNUELLE DE GRANGE
SAMEDI, LE 16 AVRIL
 13 hres.
A LA FERME LEDUC & FRERES
 Rang St-Georges
 St-Etienne-de-Beauharnois
 Rafraichissements Prix de Présence
 Pour inf.:
 Maurice Léger 264-2457
 Jane Montpetit 373-5065
 Fred Sunborg 829-2577
 Membres Club 4-H bienvenus

ENCAN
POUR ROGER BEAUDIN
50 RANG ST-ANDRE
ST-BERNARD-DE-LACOLLE
SAMEDI, LE 23 AVRIL 1983
A MIDI PRECIS

Sera vendu un troupeau Holstein comprenant 33 têtes pures et 29 têtes N.I.P. Le dernier B.C.A. annuel 150-145 et 5 vaches sur 28 ont produit plus de 20,000 lbs. de lait.
 L'âge moyen des vaches en lactation est de 4 ans et 6 mois. Un taureau né le 19 septembre 1982 pur sang enregistré, à 3 mères classées T.B. et deux soeurs classées T.B. Il est le fils de A. Robthom 1er. Le troupeau comprend 31 vaches, 9 taures saillies et 22 génisses de 0 à 15 mois. Dauge Klondike DoDo: BCA à 4 ans 7 mois de [224-210] et a deux filles dans la vente.
 Dauge Klondike Contoise: BCA à 4 ans 1 mois [181-204] Dauge Apple Lane: BCA à 2 ans 7 mois [174-184] et à 3 ans 8 mois [183-195] Helentone Anita Jester: BCA à 1 an 11 mois [146-156] à 2 ans 10 mois [172-178] et une fille de Clark Cutlass dans la vente.
 L'encan aura lieu sous la tente. 1 pipeline Surge 4 unités avec compresseur Alamo 60 plus et installation pour 34 vaches, 3 balances à lait, 1 bulk tank Mueller 500 gallons. Machineries, 1 tracteur John Deere 2140 avec cabine, double sortie d'huile, pneus "deep tread" neufs 22 heures seulement, 1 tracteur John Deere 1830 avec double sortie d'huile, 1 fourragère New Holland Super 717 en très bon état.
 Chopper New Holland de 5 pied. Wagon à ensilage neuf de Artway. Voiture à ensilage Gehl. Souffleur à ensilage, presse à foin New Holland 273 comme neuf. Rateau à foin New Holland, séchoir à foin, ratelier à foin, Haybine New Holland 467.4 voitures à foin. Moulin à foin international avec faux de 7 pied. Monte-balles en tuyau de 36 et 60 pied. Monte-balle sur fond de tôle de 24 pi. Semeur à Mais Massey Ferguson 4 rangs, semense à grain International combiné 15 roulettes. Hesses à disques John Deere 32 roulettes. Grubber International Arroseuse Tecnomo 110 gallons. Epandeur d'engrais att. 3 point, épandeur à fumier New Holland 518, épandeur fumier John Deere 33. Charrue John Deere 45 à raies, charrue Massey Ferguson, 3 raies, souffleur à neige Allied neuf, videur à silo Patz avec moteur 3 forces, hache paille Wic avec moteur de 7 1/2 HP et 80 couteaux. Benne à moulée Victoria de 6.3 tonnes métriques. Beaucoup d'autres articles trop long à énumérer.
 Ceci est une vente à ne pas manquer. Il y aura des catalogues.

QUESNEL, MASSE & ASSOCIES
 COMPTABLES AGRES - CHARTERED ACCOUNTANTS
99 SALABERRY VALLEYFIELD
(514) 373-6400

SALON DE BEAUTE UNISEXE
 ouvert aux heures régulières
 Rte 138, Trout River 264-2720
 Prix Spéciaux pour Ouverture Permanente 20,00\$ Coupe 5,00\$

RENOVATIONS R. LESSARD
 SPECIALITES:
 - Revêtements de vinyl et d'aluminium
 - Portes et fenêtres, bois, aluminium ou vinyl
 - Portes de garage, domestiques ou commerciales
 - Renovations générales
 - Ventilation
 ESTIMATION GRATUITE
264-2062

COUPON D'ABONNEMENT AU GLEANER
 Nom _____
 Adresse _____
 Code Postal _____
 Canada \$16.50 par année

Cause de l'encan: maladie
ROGEL LAMOUREUX
 Encanteur licencié
 Napierville, Que.
 Tél: 245-3435

PLACEZ UNE ANNONCE CLASSEE

ANNONCE CLASSEE ACCEPTÉE JUSQU'À MIDI LE LUNDI AU PLUS TARD

**RAPIDEMENT...
FACILEMENT...**

SIMPLEMENT APPELER

264-5364

A VENDRE

YAMAHA AUTONEIGE, vente et service. Faïlle & Frères. Tél: 827-2556. Franklin Centre. Pièces de Skiroule.

SCIES MECANIKES Homelite, Jonsereds et McCulloch; pièces vente et service. Aussi réparations de petits moteurs. Aiguillage de chaînes. Tondeuses à gazon Jacobsen. Bill MacDonald. Tél: 264-3539 ou 264-5554 Huntingdon.

MAINTENANT DISPONIBLE. Procurez-vous votre copie 1982 du Journal de la Société Historique de la Vallée de Chateaugay, sur Franklin Ste-Barbe, pour \$6,00 plus \$1,00 frais de poste et manutention. C.P. 61, Howick, Qué. J0S 1G0.

MEUBLES DE qualité à des prix modiques, Inglis, RCA, Roxtan, etc. Meubles Larry Sinray Ltd., 39 Grande Ile, Valleyfield. Tél: 373-1222.

FOURNAISES "Surefire", poêle à bois et foyers, tous éligibles à l'impôt fédéral de jusqu'à \$800. S'adresser à Alternatives, 156, rue Chateaugay, Huntingdon. Tél: 264-6245.

"KIT" DE Maison: Tous les matériaux pour une maison de 26 x 42, 3 chambres, salle de bain, cuisine, dinette, et salon, 2 x 6 charpente. Laine de 6 po. Pour aussi peu que \$10,995,00 taxe incl. Ce prix sera respecté jusqu'au 1er mai. D.N. Racine Inc. Athelstan, P.Q. J0S 1A0. Tél: 514-264-5533 ou 3222.

REFRIGERATEURS POELES-laveuses - sècheuses, reconditionnés, garantie 30 jours. Idéal pour maison ou chalet. W.D. Greig Inc., 57 Church, Ormstown. Tél: 829-2221.

HOMELITE, STIHL, Husquvarna, Jacobsen vente et service; huile à chaîne \$1,50 pour 4 litres; chaînes 16" \$14,50. Location et réparation d'équipement. Demandez pour notre spécial du mois sur scies. Location Hemmingford. Tél: 247-2968.

TRACTEUR FORD 4100 de 1980, chargeur Allied, 180 heures, \$11,500. Tél le soir: 826-1890.

KAWASAKI CSR 650, modèle 1981, \$2250. Tél: 371-8974.

MAISON-ECOLE, excellente condition, 20 x 30 pi., doit être déménagée, \$3,000. Rockburn. Tél: 264-6545.

CHEVAUX 1/2 sang Arabe (3) voiture Viceroy, étalon pur sang en service. Tél: 511-264-3689.

COFFRE DE cèdre en chêne, fait par ébéniste, idéal pour cadeau de mariage. Tél: 264-2014.

VACHES ROUVINES Gelbvieh, quatre vaches saillies, vêlant mai-juin avec papiers d'enregistrement. Bétail de qualité, haut poids de sevrage. Tom Wilson 264-3191, 264-3191.

MOTOCYLETTE HONDA 400cc 1978. Tél: 264-3855.

ROUE DOUBLE 1-18.4 x 38 roue double type à moyeu pour tracteur J.D.; 1 paire de roues doubles 14.5 x 38 type à fermoir. Tél: 264-5198.

GROSSE REMORQUE pour attacher derrière tracteur. Tél: 371-1259.

DACTYLO NEUF, dans étui en cuir. Prix \$109 le laisserait pour \$80. Cause: maladie. Tél: 371-3315.

A VENDRE

BUICK CENTURY 1976 familiale, bonne condition. Tél: 264-4933 après 6h p.m.

CALCULATRICE ELECTRIQUE Majestic presque neuve \$40; une dactylo Underwood modèle 5, bonne condition, \$75. Tél: 264-2119.

250 BALLES DE foin 2e coupe \$80 la tonne 200 balles de paille très propre. \$1,35 la balle. Tél: 264-2119.

500 BALLES DE foin; un rouleau à terrain. Tél: 825-2106.

VOLAILLES COCHIN laide Géant, Light Brama, Silver Duckling, Black Astrolop, Andalouse, Silver Blue, Rose Comb, Capine. Tél: 264-2178.

LADA 1982, en très bonne condition, \$3,900. Tél: 264-3075.

GRAND TERRAIN à vendre dans le Village d'Ormstown. Tél: 829-2903.

FOURGONNETTE TRADESMAN Dodge 77, \$2,000. Tél: 829-3723.

TELEVISION COULEUR 26" G.E. dans meuble. Demande \$200. Tél: 264-3209.

LOT DE poteaux en cèdre rouge, 7 pieds long, allant de 3 pouces à 8 pouces de diamètre. David Coffey. Tél: 264-2228.

UN CB "Realistic" 40 canaux avec antenne. Comme neuf. Prix raisonnable. Tél: 827-2944.

DIVAN EN sections, en vinyle noir, \$50. Tél: 264-6235.

FOIN ET paille. Tél: 264-6939.

CONGELATEUR 12 pi. cu. Tél: 264-3272.

MOBILIER DE salon antique, causeuse et deux chaises antiques 1 bahut, 1 mini laveuse Inglis couleur amande. Tél: 264-3083.

A OUI la chance, 450 pi. de pin 2 x 6, non plané (rough) en longueur de 8, 10, 12 et 14 pieds. Prix \$200 pour le lot 75 piquets de cèdre aiguisés. Prix à discuter. Tél: 264-6484.

POELE WESTINGHOUSE blanc 30 po., à l'état neuf. Tél: après 5 hres 829-3156.

TRACTEUR INTERNATIONAL W-4, hayoax International, 50 chaînes et plaques d'identité pour vaches, un réservoir à essence 200 gallons, un réservoir de diesel 200 gallons. Tél: 264-3730.

FOIN LIVRE. Tél: 264-5280.

CAMARO 74 rouge, bonne carrosserie, moteur récemment révisé, 4 pneus neufs, besoin d'argent, aucune offre raisonnable refusée. Demandez John après 5h p.m. Tél: 825-2251.

VENTE DE vêtements pour dames, 49, Lampton, Howick.

TRACTEUR FORD 4000 diesel, PTO, attachement 3 points, excellente condition; aussi arrosoir. Meilleure offre. Tél: soir: 827-2953.

PIANO QUART de queue (Baby Grand), 5 pieds 3 pouces, excellent, \$3,500. Rockburn. Tél: 264-6545.

POULAIN ALEZAN demi-arabe, 2 ans, enregistré, par Québec Paquet, Rockburn. Tél: 264-6545.

A VENDRE

COCHONS VERRATS en âge de service, jeunes truies en gestation. Tél: 264-2469 Frank DeVries. POELE A bois à vendre \$250. Tél: 829-3761 après 6h p.m. en semaine ou toute la journée les fins de semaine.

AJOUTEZ DES livres à vos bouillons destinés à la vente, avec un taureau de pur-race Hereford enregistré et écorné. Un éminent producteur de Hereford enregistrés et écornés de la Vallée de Chateaugay a deux taureaux de choix de l'année à vendre. Aussi génisses et veaux mâles et vaches en gestation en tout temps. Prix raisonnables. Bienvenue aux visiteurs. Westwind Valley Farm, 247-2630.

UN LOT de meubles et divers autres articles, tous en bon état, stéréo, poêle ensemble salle à manger antique, etc. Tél: 829-2905.

A LOUER

POUR ETUDIANT ou travailleuse, chambre: tapis, frigidaire, cuisine. Piscine chauffée. A certaines conditions. Tél: 371-3315, Valleyfield.

APPARTEMENT 3 chambres à coucher, disponible 1er mai. Tél: 264-6555.

GRANGE ETABLE à louer libre immédiatement. Tél: 829-1710 ou 829-2852.

APPARTEMENT 3 1/2 pièces, disponible immédiatement. A Athelstan. Tél: 264-6611 après 7 p.m.

LOGEMENT 3 1/2 pièces à Valleyfield, libre immédiatement. Tél: 829-1710 ou 829-2852.

STE-MARTINE: local à louer pour pépinière, serres, chevaux; sur terrain de 12 arpents. Tél: 825-2814.

APPARTEMENT 2 1/2 meublé, excellent pour personnes âgées. Libre 1er mai. Pour information 264-6307.

APPARTEMENT A louer à Hemmingford. Tél: 247-2968.

A LOUER: Maison dans la région de Hemmingford. Libre 1er juillet. Tél: 247-2636.

4 1/2 PIECES libre le 1er mai. Tél: 373-8205.

LOGIS DE 3 1/2 pièces, \$140. Situé 410 Lost Nation. Tél: 264-8572.

ESPACE A louer, pour bureau ou petit magasin sur rue Frontière, Hemmingford, Québec. Tél: 247-2731 ou 2967.

UN JEUNE chien Labrador noir trouvé dans région Elgin. Tél: 264-3910.

VOUDRAIT LOUER

QUOTA DE gras de lait, toute quantité. Robert E. Ness. Tél: 825-2848 Howick.

CHALET D'ETE bord de l'eau, pour mois de juillet sur lac St-François ou région de Chateaugay Lake, N.Y. Tél: 264-3305 ou 264-6797 le soir.

ON DEMANDE

ARTISANE EN court-pointes avec expérience demandée pour finir courte-pointe album 66 x 90 x 2 pouces, assemblée et faufillée. prête à piquer. Veuillez écrire à Mme J. Lavbourn, 1315 Rainbault, Ville St-Laurent, Qué. H4L 4R8.

GARDIENNE DEMANDEE chez moi, du lundi au vendredi 9 à 5 région Howick. Tél: 825-2582 après 5h p.m.

SERVICE

PEINTURE INTERIEUR et extérieur, aussi nettoyage de tapis et tout travail de gros nettoyage. Prix raisonnables. Tél: 825-2368.

A ECHANGER

BOIS DE chauffage, à échanger pour du foin. Tél: 264-4522.

TROUVE

UN JEUNE chien Labrador noir trouvé dans région Elgin. Tél: 264-3910.

PERSONNEL

EUGENE GARY T. panier aime Sylvie, Dominique Mayer.

PROPRIETE A VENDRE

ORMSTOWN MAISON 6 1/2 pièces, remise extérieure \$17,500. Tél: 264-6007.

MAISON A vendre, 3 chambres à coucher, située ville de Huntingdon, disponible 1er juillet. Tél: 264-5305 jours ou 264-2969 soirs.

FERME de Concession, Elgin, 150 acres, 120 cultivables, balançoire brousse; avec excellente maison et bonne grange; près de la route. Tél: 264-2971.

MAISON SITUÉE à Ste-Martine, Rang Bouchette, petit domaine sur terrain, 30,000 pi. car. Maison Principale 28x 30, 1 1/2 étage, 7 pièces, plus 2 pièces au sous-sol, chauffée et isolée avec foyer. Arbres matures, bord de l'eau, piscine hors-terre, aussi 3 maisonnettes plus garage. Prix demandé \$58,000. Sur rendez-vous après 5 p.m. et en fin de semaine. 427-2435.

MAISON 8 pièces, à Ormstown avec terrain 126' x 80', aqueduc et égouts, extérieur fini en déclin neuf. Libre 1er juillet. Tél: 829-3231.

CHAMBRE & PENSION

BONNE CHAMBRE et pension pour personnes âgées, dans maison privée. Tél: 264-3195.

STE-AGNES DE DUNDEE CUEILLETTE DE L'ARMEE DU SALUT MARDI, 19 AVRIL

Vêtements, meubles, jouets, livres, etc. Veuillez apporter les articles à la Salle Communautaire de Ste-Agnes le 19 avril de 9h a.m. à 5 h p.m. Pour plus d'information Tél: 264-5853 ou 4301

MAINTENANT OUVERT CLUB VIDEO ORMSTOWN

57A CHURCH ORMSTOWN

LOCATION DE MAGNETOSCOPES ET FILMS BETA ET VHS

AUSSI SYSTEME DE JEUX COLECO

PLUS DE 150 FILMS DISPONIBLES

VOUDRAIT ACHETER

HERSE A roulettes 38-40 disques; deux voyages de foin ou paille d'avoine. Tél: 264-2635.

TRAVAIL DEMANDE

CUISINIER, 8 années d'expérience en cuisine italienne, canadienne et un peu d'Arabe. Cherche travail de jour. Tél: 829-2905 demandez Denis.

POUR LE CONFORT DE VOS PIEDS CHAUSSETTES POUR TOUTE LA FAMILLE MOINS CHERES A LA DOUZAIN "LA BOITE A SURPRISE"

111, CHATEAUGUAY HUNTINGDON

PENSION

SOCIETE PROTECTION Animaux - [Shangri-La] - Centre d'adoption pour chiens et chats, examinés et vaccinés par vétérinaire. Service de pensionaire. Chemin propre et chauffé. Tél: 373-0295.

FRONTIERE ENTERPRISES
NETTOYAGE D'AUTO
INTERIEUR & EXTERIEUR
TRAITEMENT "SIMONIZE"
ET NETTOYAGE MOTEUR
71 PLAZA 219
RTE 219 HEMMINGFORD
SUR RENDEZ-VOUS 247-2551

QUENNEVILLE, BOISVENUE, LECOMTE, BOURDEAU ET ASSOCIES
Comptables Agrées - Chartered Accountants
Room 10 - 373-9993
110 Chemin Laroque, Valleyfield

SERVICE D'ABATTAGE
GROS ET DETAIL

ABATTOIR VIAU INC.

SPECIALITES
•VIANDE A CONGELATEUR
•JAMBON FUME D'AUTREFOIS
TEL: 247-2130
COVEY HILL RD. HEMMINGFORD

FRONTIERE ENTERPRISES
NETTOYEURS A LA VAPEUR
TAPIS
MEUBLES REMBOURRES
LAVAGE DE MURS & FENETRES
271 PLAZA 219
RTE 219 HEMMINGFORD
247-2551

TEL: (514) 829-2613
829-2833

Me René Therrien
Notaire
REGISTRE HECTOR CRETE
11 RUE BRIDGE
ORMSTOWN, QUE.

AVIS

Le Dr. Sonea vous avise que la Clinique Vétérinaire de Hemmingford sera fermée du 14 avril au 18 avril inclusivement. Pour urgence s.v.p. appelez: Pour chevaux: Dr Sylvie Surprenant 1-481-1285 Pour petits animaux: Drs Marcell & Johnston 825-2349. Mes excuses pour tout inconfort causé par ceci. Dr Sonea

JULES CÔTÉ **ENCAN**

SUR L'ANCIENNE FERME DE FERNAND BENOIT
266 RUISSEAU SAINT-LOUIS
MARIEVILLE (CTE ROUVILLE)
VENDREDI LE 22 AVRIL
A MIDI PRECIS

Sera vendu un gros roulant de ferme comprenant: 5 tracteurs dont un International no. 674 diesel avec power-steering, barrage de roues, sorties hydrauliques et cabine - seulement 1783 heures; un International no. 806 avec roues doubles, power steering, barrage de oute [2745 heures]; un Massey-Ferguson no. 65 diesel avec power steering; un Massey-Ferguson no. 2085 au gaz avec pesée arrière et chargeur sur le devant muni de fourche à fumier et de pelle à neige; un International W-9 au gaz avec poulie; un bulldozer International TD-9 avec niveleuse ajustable sur l'arrière; et une grosse grappe sur roues pour faire du terrassement; et une grosse remorque à bulldozer avec 2 paires de roues doubles, treuil sur l'avant et montée arrière basculante. Machinerie: une batteuse International no. 105 avec faux de 10 pds et pick-up, souffleuse à neige neuve causeuse à épis New Idea à 2 rangs; Causeuse à épis Oliver sur prise de force; faucheuse-conditionneuse New Holland no. 479 avec cylindre; charrue déchencheuse International à 3 raies avec att. 3 pds; charrue International à 5 raies - modèle semi-porté avec cylindre; charrue tractante à 3 raies; charrue défonceuse neuve à 4 oreilles avec att. 3 pds; engrenage à blé d'inde Hanan sur orise de force; Moulin à faucher International de 7 pds avec att. 3 pds.; arroseuse Calsa avec att. 3 pds. Presse à foin; herse à roulettes International à 56 roulettes avec oreille repliante [genre remorque]; herse à roulettes 16 x 32 avec cylindre; 2 voitures avec 3 essieux arrière 2 essieux avant et montant à foin de 26 pds; 4 voitures sur pneus avec boîte à grain Lajoie; voiture tandem avec montant à foin de 20 pds grosse remorque tandem pour épandre l'engrais chimique, fonctionne sur prise de force; remorque tandem; remorque avec roues doubles et pompeuse; fanuse à foin Fahr; râteau de côté New Holland no. 256, sarclateur avec att. 3 pds. Andaineuse International no. 175 auto., semeuse Ford à 4 rangs combinée pour engrais chimique; semeuse McCormick 16 disques; gros réservoir d'arrosage; 2 séchoirs à grain; vis à grain L. Brandt neuve de 8 pds x environ 40 pds sur roues; vis à grain sur roues; vis à grain avec moteur monte-balle International de 48 pds avec fond de tôle; monte-balle avec moteur; éventail à foin; 7 niveleuses ajustables neuves avec att. 3 pds et cylindres de différentes grosseurs; compresseur à air; 2 étaux; 2 press drills; scie à fer électrique; 2 grosses presses pour redresser le fer; enclume; jack à l'huile; sondeuse électrique Westinghouse; soudeuse au gaz; cabinet à boutons [bolts]; très grande quantité de fer neuf et tout le stock de hangar. Aussi 18 sacs de semence de blé certifiée; très grande quantité de blé; quantité de paille; un réfrigérateur de maison; congélateur poêle électrique laveuse et sècheuse et quelques bureaux. Conditions: comptant ou prêt de banque

Pour informations ou demande de crédit s'adresser à l'encan

JULES CÔTÉ INC
1274 rue SUD Cowansville, Que.
Encanteur bilingue licencié
263-0670
263-1434

Trust Royal
Services immobiliers

HUNTINGDON: Cottage 6 pcs., garage, paysagé, bord de rivière, 1 mille de la ville. EXCL.
ST-ANICET: Bungalow 5 pcs., 4 saisons, garage, près du lac, secteur estival, chemin ouvert toute l'année. EXCL.
STE-BARRE: Bord du lac St-François, chalet 5 pcs., foyer, remise bateau, secteur privé. SIM.
ST-ANICET: Bord de l'eau, bungalow 4 saisons, remise bateau, chauff. élect., près du golf. SIM.
ST-ANICET: Maison style chalet suisse, 7 pcs., foyer, garage secteur calme, 6 acres terrain boisé. MLS.
Normande Grégoire, 264-3218, 371-1640 Trust Royal, Courtier.

Regie des permis d'alcool du Québec

AVIS DE DEMANDE DE PERMIS D'ALCOOL

Toute personne, société ou groupement visé dans l'art. 60 du Code de procédure civile peut, par écrit motivé, assemblée et transmis à la Régie, s'opposer à une demande de permis d'alcool, énumérée, dans les 15 jours de la présente publication, ou s'y opposer, intervenir en faveur dans les 30 jours de cette publication. Cette opposition ou intervention doit être accompagnée du certificat attestant de son envoi au requérant ou à son procureur, par poste recommandé et dûment enregistré. La Régie des permis d'alcool du Québec, 1, rue Notre-Dame Est, suite 9.200, Montréal, Québec, H2V 1B6.

Nom et adresse	Nature de la demande	Endroit d'exploitation
SMITH, Margaret 1041 Route 219 HEMINGFORD	1 épicerie	1039 Route 219 HEMINGFORD
		83-04-13

Le président et directeur général
Ghislain K.-Lafamme, avocat

PROVINCE DE QUEBEC MUNICIPALITE DE CANTON DE DUNDEE

AUX CONTRIBUABLES DE LA SUSDITE MUNICIPALITE

AVIS PUBLIC

Est par les présentes donné par le soussigné, secrétaire-trésorier de la susdite municipalité, que: Le bureau du soussigné est fermé du 11 avril au 2 mai 1983, inclusivement, et que pour tout paiement de taxes municipales envoyé par la poste, un reçu à cet effet vous sera envoyé dans l'immédiat par le soussigné. Donné à Ste-Agnes-de-Dundee ce neuvième jour de avril 1983.

Howard L. Welburn
Secrétaire-Trésorier

Beatrice Van Winden
Secrétaire-Trésorier

GAMME COMPLETE DE MATERIAUX DE CONSTRUCTION PLOMBERIE QUINCAILLERIE ELECTRICITE PLANS DE MAISONS DISPONIBLES

• SOUMISSION GRATUITE SUR TOUS GENRES DE PROJETS

GRADUE EN AMENAGEMENT ET DESIGN A VOTRE DISPOSITION POUR MIEUX VOUS SERVIR

BMR D. N. RACINE INC. 264-5533
264-3222
ATHELSTAN, QUEBEC

Une nouvelle ligue sportive a vu le jour à Huntingdon

texte de Cyril Alary
Huntingdon - Une nouvelle ligue sportive a vu le jour à Huntingdon, et il s'agit de la Ligue de Balle-

Molle du Dimanche Matin. En effet, le premier repêchage des joueurs de cette nouvelle association a eu lieu dimanche soir, le 10

avril, au Château de Huntingdon. Ce circuit est présidé par Jean-Luc Crête. Les autres membres du conseil de

direction sont Pierre Renaud au poste de secrétaire trésorier, Mike Beauvais au poste de directeur en charge de

l'équipement, Jean-Louis Royal, directeur en charge des substitués, Steve Deme et Ghislain Crête, tous deux directeurs en charge des arbitres.

Quatre équipes forment cette ligue, et les commanditaires sont Donald Racine, Lave-Auto Ian Ferns, Cley & Tinker, et Marché IGA Robert Plouffe.

Suite à ce repêchage, plusieurs joueurs ont déjà commencé à parler de stratégie entre eux en vue du début de la première saison le dimanche 24 avril prochain.

Voici la composition des quatre formations de cette nouvelle ligue:

• Marché IGA de Robert Plouffe: le capitaine Ghislain Crête, René Saumier, Louis Ricard, Gaétan Viau, Gaétan Crête, René Lefebvre, Paul-André Quinn, Michel L'Heureux, Guy Fournier et Jean-Marie Quinn;

• Cley & Tinker: le capitaine Steve Deme, Alex Deme, Richard Laflamme, Charles Quinn, Jean-Luc Crête, Michel Caza, Alain Caza, André Taillefer, Mario Montreuil et André St-Onge;

• Donald Racine Inc.: le

capitaine Jean-Louis Royal, Denis Royal, David L'Heureux, Christian Langevin, Daniel Quinn, Claude Quinn, Robert Royal, Roger Lefebvre, Richard Lazure, Donald Deme;

• Lave-Auto Ian Ferns: le capitaine Mike Beauvais, Michel Mainville, Réjean Blanchette, Jean Brunet, Pierre Renaud, Bruce Legault, Denis Gaudet, Jean Robert, Randy Renaud et Danny Arthur.

L'ouverture officielle de cette nouvelle ligue aura lieu à 10 heures dimanche le 24 avril prochain au terrain de l'École Polyvalente Arthur Pigeon de Huntingdon.

Camille Laurin dans le comté

texte de Cyril Alary
St-Urbain - Le ministre de l'Éducation du Québec, le docteur Camille Laurin, sera en visite dans le comté de Huntingdon dans le cadre de la campagne de financement du Parti Québécois.

En effet, Solange Fortin, présidente de l'exécutif du PQ du Comté de Huntingdon, a confirmé la présence du ministre Camille Laurin à la Cabane à sucre Le Relais de St-Urbain vendredi le 22 avril prochain à compter de 19

heures. C'est ainsi que les militants péquistes du comté de Huntingdon sont invités à "apporter une contribution en temps, en énergie et en argent" en vue de la prochaine campagne électorale dont le thème principal sera l'indépendance.

Les organisateurs de cette soirée à la cabane à sucre osent croire qu'il y aura bonne foule pour venir entendre les propos intéressants du ministre Camille Laurin.

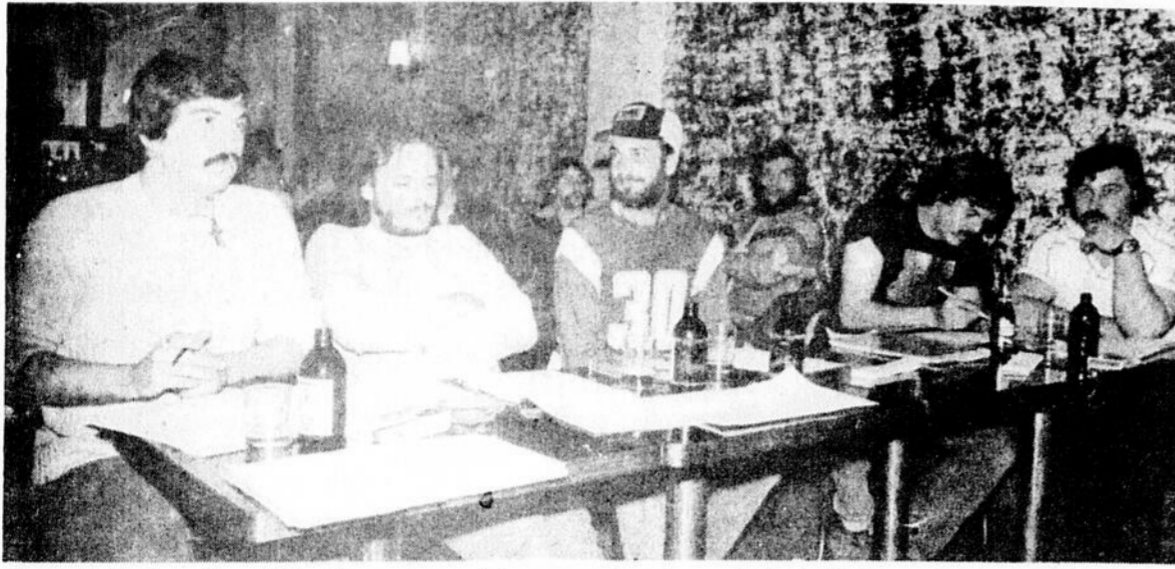

Dimanche le 10 avril, avait lieu le premier repêchage officiel de la nouvelle Ligue de Balle-Molle du Dimanche Matin de Huntingdon. On reconnaît sur la

photo les capitaines Ghislain Crête, Steve Deme, Jean-Louis Royal, Mike Beauvais et le secrétaire-trésorier Pierre Renaud



La nouvelle Ligue de Balle-Molle de Huntingdon comprend quatre formations commanditées par Ian Ferns du Lave-Auto, par Donald Racine Inc., représenté par Luc Racine, Cley & Tinker représenté par Jean-Pierre Philie, et le Marché IGA Robert Plouffe, représenté par Ghislain Crête.



Pierre Renaud (à gauche), secrétaire-trésorier, et Jean-Luc Crête (à droite), président de la nouvelle ligue, ont chaleureusement accueilli Robert Plouffe, commanditaire d'une formation.

Le conseil vient en aide à deux associations

texte de Cyril Alary
Huntingdon - L'exposition agricole annuelle de Huntingdon ne recevra que 200\$ de la Ville de Huntingdon à titre de contribution financière pour l'année 1983.

Cette décision du conseil, lors de la rencontre du 5 avril dernier, a été prise par un vote majoritaire de 3 contre 2.

En effet, une première proposition de l'échevin Richard Grant prévoyait une aide financière de l'ordre de 750\$. Le tout a été secondé par l'échevin Douglas Field.

Toutefois, cette

proposition devait être battue lors d'un vote à la table du conseil. Alors, l'échevin Georges Lazure a fait une autre proposition, soit l'octroi d'un montant de 200\$, tout en spécifiant que la Ville donnait plusieurs services essentiels à la réalisation de cette foire agricole.

"Les employés de la Ville vont poser la clôture à neige sur le terrain de l'exposition, et en plus les employés font la cueillette des ordures durant les quatre jours de la foire", a précisé l'échevin Georges Lazure. C'est pourquoi, selon lui, une aide finan-

cière de l'ordre de 200\$ est justifiée. En plus de l'échevin Lazure, les échevins Claude Bourassa et Normand Nadeau ont voté en faveur de cette proposition de 200\$, tandis que les échevins Richard Grant et Douglas Field votaient contre.

Aide à Madrigal: Par la même occasion, le conseil a décidé de venir en aide au Choeur Madrigal qui se prépare à présenter à la fin du mois deux concerts.

Un montant de 25\$ a été octroyé à ce groupe. Cette décision a été prise unanimement.

En bref...

• Avril est le mois de la santé dentaire, et le tout a été lancé par une campagne de sensibilisation de la population à la santé bucco-dentaire.

• Louis Sincennes est le nouveau représentant de la zone de Valleyfield au Conseil Culturel de la Rive-Sud. Il remplace ainsi Jean-Pierre Leduc de Valleyfield. Louis Sincennes est un comédien formé au Conservatoire d'art dramatique, et il a joué sur plusieurs scènes tant à Montréal que dans la région de Valleyfield.

Un blessé

texte de Cyril Alary
St-Chrysostôme - Un accident de la circulation vers les 7 heures 20 le 29 mars dernier a fait un blessé.

En effet, Greg Edwards de Franklin Centre, au

volant d'une Pontiac '79, a été blessé légèrement, et il a été conduit au Centre Hospitalier Barrie Memorial d'Ormstown afin d'y recevoir les premiers soins nécessaires.

Cet accident s'est déroulé sur la route 203 à St-Chrysostôme. L'autre véhicule impliqué, un camion Dodge '73, était conduit par Jacques Cardinal de St-Chrysostôme.

Les deux véhicules ont reçu des dommages de plus de 500\$. L'agent Clément Roy du détachement de Ste-Martine de la Sûreté du Québec a fait les constatations d'usage.

NOUVEAU SERVICE CHEZ VOTRE SPECIALISTE EN COUVRE-PLANCHERS

VENTE ET INSTALLATION STORES HORIZONTALS ET VERTICAUX "HUNTER DOUGLAS"

LAMELLES ALUMINIUM OU ACRYLIQUES

QUALITE ET SERVICE

COUVRE-PLANCHERS - PAPIERS - PEINTS

E. LATREILLE

264-3276

HUNTINGDON

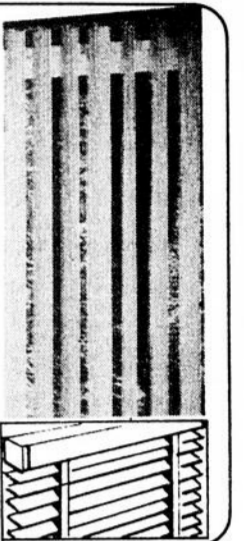

PEUGEOT OUTILLAGE ELECTRIQUE

DES OUTILS PAS COMME LES AUTRES

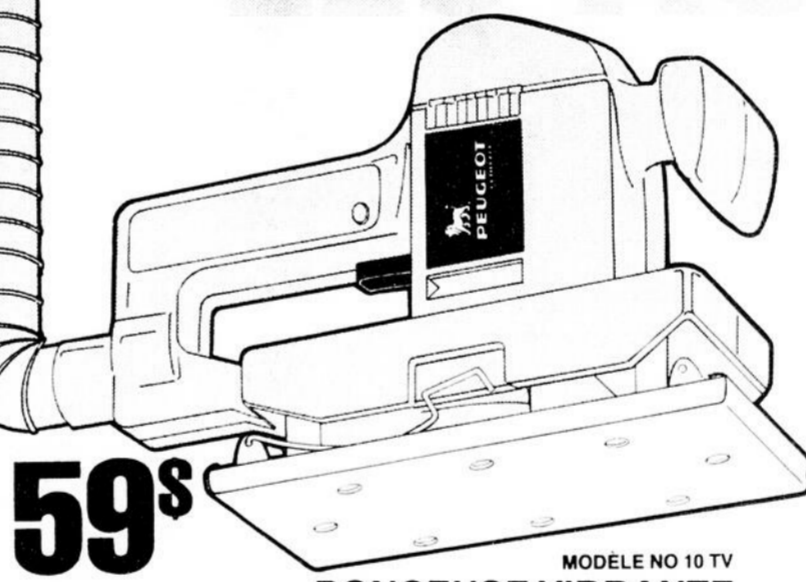

59\$

MODELE NO 10 TV
PONCEUSE VIBRANTE "AVALÉ-POUSSIÈRE"

Travail propre et parfait, elle aspire la poussière au fur et à mesure qu'elle ponce par les trous de sa semelle. En outre, la dépression créée par l'aspiration améliore l'efficacité du ponçage et les abrasifs durent plus longtemps car ils s'encrent moins. (Tuyau d'aspiration non-inclus). Les mouvements sont montés sur roulement à billes.

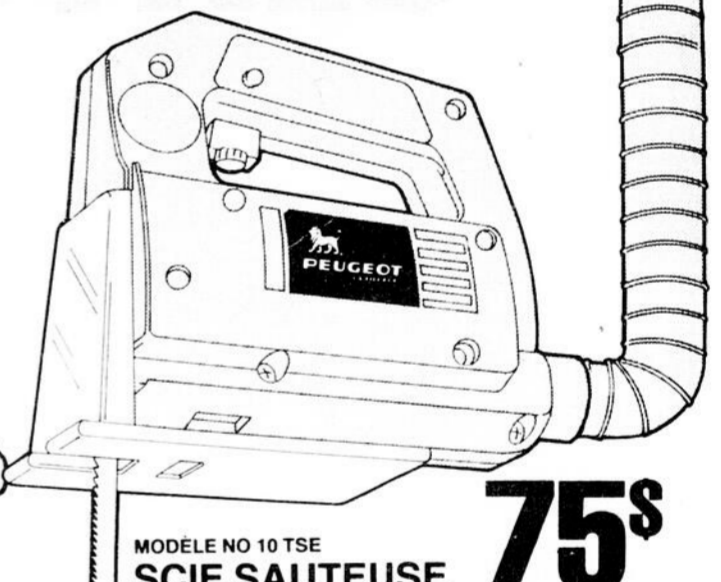

75\$

MODELE NO 10 TSE
SCIE SAUTEUSE "TRI-AXIALE"

Accélérateur-variateur électronique, tableau de sélection des vitesses, éclairage incorporé. Montage des lames dans 3 directions. Aspiration des sciures par raccordement à un aspirateur. (Tuyau d'aspiration non-inclus). Les mouvements sont montés sur roulement à billes.

SYSTÈME UNIQUE D'ASPIRATION

des poussières à la source, qui vous assure un travail propre, c'est simple et efficace! Disponible en supplément sur la plupart des outils électriques Peugeot.



99\$
MODELE NO PC685
PERCEUSE 1/2" À PERCUSSION "TOUS TERRAINS"

500 watts — 13 mm béton — variateur de vitesse électronique et inverseur du sens de rotation avec dispositif de contre-réaction électronique. L'accélérateur électronique de vitesse permet d'effectuer un travail fin à basse vitesse puis de monter progressivement à la vitesse préselectionnée. Les mouvements sont montés sur roulement à billes.



62\$
MODELE NO PC582
PERCEUSE 3/8" À PERCUSSION "TOUS TERRAINS"

280 watts — 10 mm béton à deux vitesses électriques. Grâce à sa légèreté et à sa compacité, cette machine est idéale pour réaliser tous les travaux courants. Une perceuse à percussion à prix raisonnable qui peut exécuter facilement la plupart des travaux dans tous les matériaux y compris le béton. Les mouvements sont montés sur roulement à billes. Le système d'aspiration se peut être adapté à cette perceuse.

EN EXCLUSIVITÉ CHEZ

LE Renovateur RONA



ET CHEZ VOTRE QUINCAILLIER RONA

TOUT POUR VOS SEMIS DU PRINTEMPS

COMPAREZ NOS PRIX

- POSTE DE CRIBBLAGE - SEMENCES - PESTICIDES - MILLAGE
- ENGRAIS - ACCESSOIRES DE JARDIN
- ET AUTRES PRODUITS

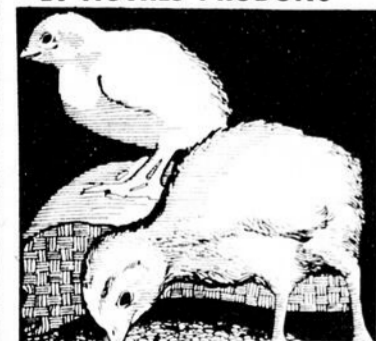

COMMANDEZ AVANT LE 30 AVRIL POUR VOS VOLAILLES

- RACE A CHAIR
- POULETTES
- DINDONNEAUX
- CANARDS
- OIES, ETC.



LES CEREALES D.L. LTEE

25 AVE DU PONT ST-LOUIS DE GONZAGUE

TEL: 373-4373

DEPOSITAIRE Master