

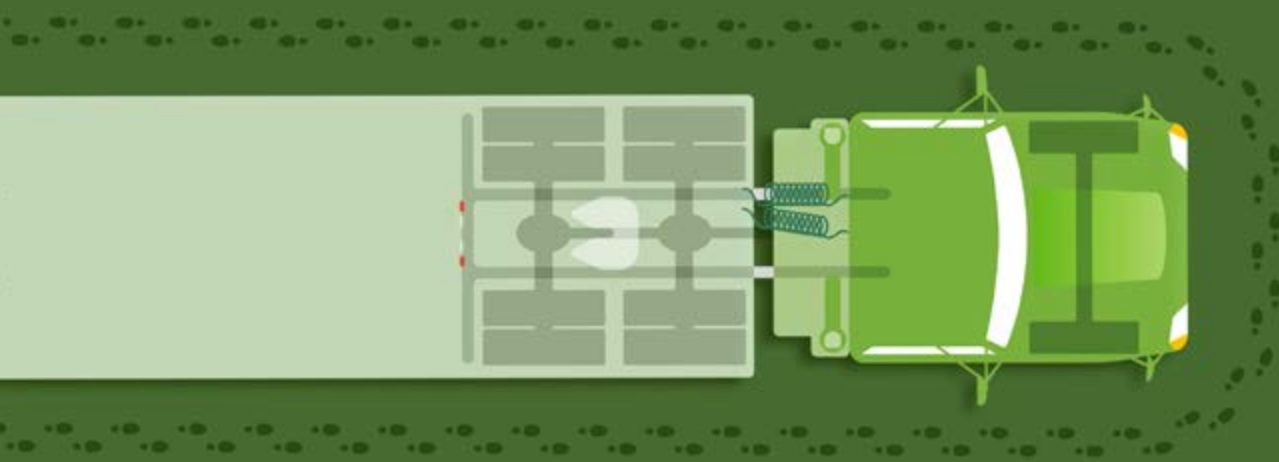

Circle Check Guide



Circle Check Guide

Legal deposit – Bibliothèque et Archives nationales du Québec, 1st quarter, 2016

Print version: 978-2-550-77107-4

PDF version: 978-2-550-77108-1

© Société de l'assurance automobile du Québec, 2016

All rights reserved for all countries.

Reproduction by any means and translation of any part of this document are prohibited without the authorization of the Société de l'assurance automobile du Québec.

Original text in french.

Introduction	5	▪ Special considerations	12	▪ Example of the inspection method for a motor coach (List 3)	32
How to Use This Guide	7	▪ Lists of defects	13		
Circle Check (Administrative Component)	8	▪ Mechanical component of the circle check	14	Circle Check (Mechanical Component)	38
▪ What is the circle check?	8	▪ Presence of defects	15	▪ Introduction	38
▪ Vehicles subject to a circle check	8	▪ Circle check report	16	▪ List of Systems	39
▪ Vehicles exempt from a circle check	9	▪ Keeping documents	18	1 Coupling Devices	40
▪ Is the circle check mandatory?	9	Inspection Methods	19	Fixed or Sliding Fifth Wheel Coupling Device	43
▪ Who is required to perform the circle check?	9	▪ What method should be used to perform the circle check?	19	Hook and Ring Coupling Device	50
▪ When must the circle check be performed?	10	▪ What material should be used to perform the circle check?	19	Other Coupling Devices (e.g. gooseneck, ball and hitch)	53
▪ Vehicles used by more than one driver	11	▪ Example of the inspection method for a semi-trailer hitched to a tractor truck (List 1)	20	2 Frame and Cargo Body	55
▪ Vehicles used by team drivers	12	▪ Example of the inspection method for a school bus (equipped with hydraulic brakes) (List 2)	27	3 Heater/Defroster	59
▪ Who is responsible for reporting defects detected during the trip?	12			4 Driver Controls (accelerator, clutch and horn)	61
				5 Steering	65
				6 Windshield Wiper/Washer	70
				7 Emergency Material	72



8 Headlights and Lights	75
9 Tires	81
10 Doors and Other Openings	86
11 Glass and Mirrors	89
12 Wheels, Hubs and Fasteners	93
13 Seat	98
14 Suspension	100
15 Fuel System	106
16 Exhaust System	108
17 Electric Brake System	110
18 Hydraulic Brake System	113
19 Pneumatic Brake System	121
20 Passenger Transport	130

Occupational Injury Prevention	139
▪ Refusing to perform work	139
▪ Risks and how to prevent them	140
Appendices	144
▪ Appendix 1 – Sample Circle Check Report	145
▪ Appendix 2 – Lists of Defects	146
List 1 – Heavy Vehicles	146
List 2 – Buses	151
List 3 – Motor Coaches	157
▪ Appendix 3 – Pressure Conversion Table	162
▪ Appendix 4 – Measurement Conversion Table (length)	164
▪ Appendix 5 – Offences	167
Glossary	170

Introduction



Mechanical defects related mainly to brakes, tires, wheels, and coupling devices are a determining factor in more than 10% of heavy vehicle accidents. They also cause a significant loss of productivity in the transportation of goods and passengers industry. Yet, most of those defects could be detected during a proper inspection of the vehicle before it is used.

Either the driver or a person designated by the operator must perform the vehicle inspection in order to ensure that it complies with the standards in effect. The *Highway Safety Code* specifies that all heavy vehicles must have been checked within the previous 24 hours, otherwise a new "circle check" must be carried out.

The purpose of the circle check is to ensure that:

- the principle components of the vehicle are in good condition;
- the vehicle's owner and operator are informed of the repairs to be made;
- no vehicles with major defects are operated on our roads.

The ultimate objective is to improve safety for all road users.

How to Use This Guide



This guide is intended for heavy vehicle owners, operators and drivers and all stakeholders in the transportation industry who play a role in heavy vehicle maintenance and road safety.

The information in this guide cannot be used for legal purposes. In this regard, you should consult the relevant sections of Québec's *Highway Safety Code*, the *Regulation respecting safety standards for road vehicles* and the *Act respecting owners, operators and drivers of heavy vehicles*.

An appended glossary provides exact definitions of certain terms used in this guide.

Icons:

Here is the meaning of the icons used in this guide:



MINOR defect



MAJOR defect



Helpful tip or advice that makes it easier to understand a more complex point or carry out a particular task



Offence under Québec's *Highway Safety Code*

Circle Check (Administrative Component)

8

■ What is the circle check?

The circle check is a sight and sound inspection of the accessible components of a vehicle that makes it possible to:

- detect defects as early as possible;
- quickly notify the owner and operator of any defects detected;
- prevent the vehicle from being operated when its condition poses a risk of an accident or a breakdown.

Important! Drivers must carry out these inspections safely.

■ Vehicles subject to a circle check

Road vehicles with a gross vehicle weight rating (GVWR)¹ of 4,500 kg or more

For example:

- Ambulances;

- Cement mixers;
- Tank trucks
- Fire trucks;
- Straight-body trucks;
- Snow removal trucks;
- Vans;
- Pickup trucks;
- Trailers;
- Semi-trailers;
- Road tractors;
- Emergency response vehicles;
- Equipment transport vehicles (compressors, well drills, concrete pumps, cranes mounted on a truck chassis).

Combinations of road vehicles that include at least one vehicle with a GVWR or 4,500 kg or more

For example:

- A pickup truck with a GVWR of **less than 4,500 kg** to which is hitched a trailer or semi-trailer with a GVWR of **4,500 kg or more**;

- A pickup truck with a GVWR of **4,500 kg or more** to which is hitched a trailer or semi-trailer with a GVWR of **less than 4,500 kg**;
- A pickup truck with a GVWR of **4,500 kg or more** to which is hitched a trailer or semi-trailer with a GVWR of **4,500 kg or more** (each vehicle in the combination has a GVWR of 4,500 kg or more).



Since the entire vehicle combination is subject to the circle check, both vehicles must be inspected – not only the vehicle with a GVWR of 4,500 kg or more.

Buses, minibuses and tow trucks (regardless of GVWR)

For example:

- Motor coaches;
- Minibuses;

1. GVWR (or gross vehicle weight rating) = net weight + maximum load capacity.

- School buses;
- Paratransit minibuses;
- City buses;
- Tow trucks (all types).

Road vehicles with a GVWR of less than 4,500 kg transporting dangerous substances and requiring the display of safety marks

Vehicles or combinations of vehicles (automobiles, pickup trucks, etc.) requiring the display of safety marks, for example:



■ Vehicles exempt from a circle check

- Tool vehicles
 - Graders,
 - Loaders,
 - Back hoes,

- Heavy vehicles required by an emergency service or in the event of a disaster;
- Farm tractors;
- Farm machinery (e.g. combine-harvesters);
- Farm trailers (e.g. a hay trailer owned by a farmer and used for farming purposes);
- Heavy vehicles **used** by a natural person for **personal ends**, i.e. other than for commercial or professional purposes (e.g. a truck used to move household belongings, a motor home, etc.);
- Straight-body trucks with two or three axles used to:
 - transport unprocessed farm, forest or fishery products, provided the driver is also the producer, or
 - make the return trip, provided the truck is either empty or used to transport products mainly used in the operation of a farm, forest or fishery.

■ Is the circle check mandatory?

The circle check is **mandatory** for all vehicles subject to this inspection. Therefore, a **driver** cannot drive a vehicle and an **operator** cannot let a

vehicle be driven if the circle check has not been carried out within the regulatory time frame.

■ Who is required to perform the circle check?

The **driver** must perform the circle check of the vehicle he or she is driving.

The circle check can also be performed by a **person designated by the operator**. In that case, the operator becomes accountable for the circle check and the driver may accept or refuse the report.

- **If the driver accepts the report**

He or she makes sure that the circle check is valid (carried out within the previous 24 hours) and co-signs the report to acknowledge it. Accepting the report does not render the driver accountable for the circle check, but the driver **must keep the report up to date** and record any defects observed during the trip.
- **If the driver refuses the report**

The driver must perform a new circle check and fill out a new report.





The person designated by the operator can be a driver. In that case, it is important that the circle check report indicate that this driver performed the circle check as the person designated by the operator.

Particularities for buses, minibuses, tow trucks and emergency vehicles

In the case of a bus, a minibus, a tow truck or an emergency vehicle, the driver can accept and co-sign the circle check report completed by the previous driver, even if the latter person is not a person designated by the operator to carry out the circle check.

- **If the driver accepts the report**
He or she makes sure that the circle check is valid (carried out within the previous 24 hours) and co-signs the report to acknowledge it. **Accepting the report then renders the driver accountable for the circle check carried out by the previous driver**, as it was not carried out by a person designated by the operator. **The driver** must also keep the report up to date and record any defects observed during the trip.
- **If the driver refuses the report**
The driver must perform a new circle check and fill out a new report.

■ When must the circle check be performed?

Before getting behind the wheel, drivers must make sure that **a circle check of their vehicle was completed within the previous 24 hours. If this is not the case, a new circle check must be performed.**²

However, if the circle check was not performed by a person designated by the operator, the driver must perform a new circle check, even if one was completed within the previous 24 hours, as the driver cannot co-sign the circle check report.

Note that this rule does not apply to buses, minibuses, tow trucks and emergency vehicles, as the driver can co-sign the circle check report completed by the previous driver, even if that driver is not a person designated by the operator to perform the circle check.

2. In the case of buses, minibuses and emergency vehicles, Saturdays, Sundays and statutory holidays are not taken into account in the 24-hour period following the last circle check, **on the condition that the vehicle remains parked on those days.**



When they are at the wheel, drivers must organize their activities so as to be able to perform a new circle check before the prescribed 24-hour period expires. For example, for a circle check completed at 7:00 a.m. on June 12, the driver must perform a new circle check before 7:00 a.m. on June 13 otherwise he or she will be prohibited from driving the vehicle.

■ Vehicles used by more than one driver

Buses, minibuses, tow trucks and emergency vehicles

As indicated in the section entitled “Who is required to perform the circle check?”, if the circle check was performed by a person designated by the operator, each driver must read the report, make sure the circle check was performed within the previous 24 hours, co-sign the report if he or she accepts it and be sure to keep it updated. If a driver refuses the circle check performed by the designated person, he or she must perform

a new circle check and thus assume responsibility for it.

If the circle check was performed by a driver who is not a person designated by the operator, successive drivers can accept the circle check report and co-sign it or perform a new circle check. If the driver co-signs the report, the driver at the wheel of the vehicle is accountable for the circle check performed by the previous driver. The driver must also keep the report up to date and report any defects observed during the trip.

Other vehicles subject to the circle check

When a vehicle is used by more than one driver, each driver must perform a circle check before getting behind the wheel. However, if the circle check was performed by a person designated by the operator, the other drivers can simply co-sign the report if they accept it.

In the event that a driver refuses a circle check report completed by a person designated by the operator, he or she must perform a new circle check and complete a new report. All subsequent drivers will also have to do so because the most recent circle check was not performed by a person designated by the operator.

If the circle check is not performed by a person designated by the operator, a driver who once again uses a vehicle for which he or she has performed a circle check within the previous 24 hours is not required to complete a new circle check report. However, the driver must make sure that the report he or she has completed is on board the vehicle and that it still accurately reflects the vehicle’s condition. Therefore, when another driver has used the vehicle in the meantime, it is recommended that the driver perform a new circle check or read the other driver’s circle check report in order to update his or her report if any defects have been detected since he or she completed the report.



■ Vehicles used by team drivers

When the vehicle is used as a team, the following method is recommended if the operator has not designated one of the drivers to perform the circle check: the first driver performs the circle check and fills out the circle check report; the relief driver performs a new circle check and fills out a new report before getting behind the wheel. Both reports remain valid for a period of 24 hours.

If the operator has designated one of the drivers to perform the circle check, the other driver can read the report before getting behind the wheel and either:

- co-sign the report if he or she accepts it; or
- perform a new circle check and fill out a new report if he or she refuses it.

Motor coaches used by team drivers

When preparing to take the wheel, the relief driver can co-sign the first driver's circle check report if he or she accepts it, even if the preceding driver was not designated by the operator to perform the circle check. In such a case, the driver

behind the wheel is accountable for the circle check performed by the preceding driver. The driver must also keep the report up to date and record any defects observed during the trip.

■ Who is responsible for reporting defects detected during the trip?

Drivers are responsible for reporting defects detected during the trip, even if the circle check was performed by a person designated by the operator.

Drivers:

- are in **the best position** to detect symptoms of unusual behaviour in their vehicle;
- must always be able to carry out an inspection of their vehicle and recognize the defects normally detected during a circle check.



If the driver is unable to determine whether a problem is actually a defect, he or she should nevertheless report the problem to the operator, who will then make the necessary verifications.

■ Special considerations

Road tests

For a road test, the circle check is **not required if all of the following conditions are met:**

- the road test is carried out within a **15-kilometre radius** from the location where the vehicle is being repaired;
- the vehicle is **not carrying any goods**, except the equipment with which it is permanently fitted;
- the vehicle is **not carrying any passengers**, other than those involved in the road test;
- the most recent circle check report or job card is on board the vehicle.

Fire department vehicles

The circle check for a fire department vehicle must have been performed within 24 hours of the vehicle leaving or returning to the fire station. When the vehicle stays in the fire station, the circle check must be performed at least once every 7 days.

Buses or minibuses used for urban transit and operated by a public transit authority

The circle check remains valid for either of the following periods, whichever comes first:

- 48 hours, if the vehicle remains parked indoors for this entire period;³
- 24 hours from the time the vehicle is called into service.

This particularity only applies when **the following conditions are met:**





- the circle check is performed by a person designated by the operator;
- the vehicle is a bus or minibus used for urban transit and operated by a public transit authority.

■ Lists of defects

What is a list of defects?

The list of defects is a **checklist** that enumerates the components to inspect and the **defects that can be detected on a vehicle**. It is used to determine whether defects noted during a circle check are **minor** or **major**.

There are three lists of defects that must be used during the circle check.

	List 1 Heavy vehicles, other than those covered by lists 2 and 3
 	List 2 Buses (other than motor coaches), minibuses and trailers hauled by a bus, minibus or motor coach
	List 3 Motor coaches exclusively ⁴

Must the list of defects always be on board the vehicle?

The list of defects is mandatory and must always be on board the vehicle.

Operators are required to:

- place the applicable list of defects on board every heavy vehicle under their responsibility;
- make sure the driver keeps the list on board the vehicle.

3. Saturdays, Sundays and statutory holidays are taken into account in the 48-hour period from the time the circle check was performed if the vehicle remains parked indoors on those days. This rule only applies to circle checks performed by a person designated by the operator for that purpose for buses and minibuses operated by a public transit authority and used for urban transit.
4. If a motor coach is not subject to a preventative maintenance program (PMP) recognized by the Société de l'assurance automobile du Québec, the driver must make sure to have on board the report of the inspection specific to motor coaches and List 3. The owner must complete this report every 12,000 km or every 30 days, whichever comes first, and place the report on board every motor coach under his or her responsibility.



Drivers are required to:

- make sure the list of defects that applies to the heavy vehicle under their responsibility is and remains on board the vehicle;
- surrender the list to any peace officer who asks for it.

Is the format for the list of defects regulated?

The operator must provide a list of defects in the format prescribed by the *Regulation respecting safety standards for road vehicles*. They cannot change the texts, the order in which the defects are presented or the numbering. They can, however, add elements in the section entitled "Specific inspections required by the operator".

Sample compliant lists are appended to this guide.

■ Mechanical component of the circle check

Main obligations

- Owners:
 - maintaining their vehicles in good mechanical condition.
- Operators:
 - ensuring the driver or the person they designate performs the circle check;
 - ensuring all mandatory components are inspected.
- Drivers:
 - performing the circle check, unless they accept the circle check and co-sign the report;
 - > from the person designated by the operator,
 - > from the preceding driver (buses, mini-buses, tow trucks and emergency vehicles);
 - reporting any defects noted during the trip.

Categories of defects



Minor Defects

A minor defect does not pose an immediate threat to the safety of the driver or other road users, but can deteriorate quickly in certain cases. A vehicle with a minor defect is prohibited from being operated if repairs are not performed within 48 hours.



Major Defects

A major defect poses an immediate threat to the safety of the driver and other road users. A vehicle with a major defect is prohibited from being operated.

Principal components to inspect during a circle check

The circle check covers the various components of a vehicle, namely:

1. Coupling devices
2. Frame and cargo body
3. Heater/defroster
4. Driver controls
5. Steering
6. Windshield wiper/washer
7. Emergency material
8. Headlights and lights
9. Tires
10. Doors and other openings
11. Glass and mirrors
12. Wheels, hubs and fasteners
13. Seat
14. Suspension
15. Fuel system
16. Exhaust system
17. Electric brake system
18. Hydraulic brake system
19. Pneumatic brake system
20. Passenger transport



Vehicles are not necessarily equipped with all the components referred to in the list of defects (e.g. hydraulic brakes). In such cases, the components do not have to be inspected. However, when certain components with which a vehicle must be equipped are missing, their absence constitutes a defect that must be reported.

■ Presence of defects

What to do if a defect is detected?

Owners must maintain their heavy vehicles in good mechanical condition. They must therefore be informed of any defect so that it can be corrected and maintain the right to operate the vehicle.

What defects must be reported?

Drivers must report any defect that appears in the list of defects that applies to the vehicle they are driving, regardless of whether the defects are minor or major.



If the driver detects a defect that does not appear on the list, or if the driver is informed of such a defect, it is recommended that the driver enter the defect in the circle check report and report it to the operator, who can have the repairs made and prevent the situation from deteriorating.

When and how should a defect be reported?

Minor defects

A minor defect **must be entered in the circle check report and reported to the operator before the next circle check or within 24 hours**, whichever comes first.

It is **recommended that a minor defect be reported as soon as possible.**

- The sooner the operator is informed, the more quickly the repairs can be made. In some cases, the defect can even be repaired before the vehicle is taken back out on the road.



- Drivers must comply with the notification time frame requirements if another driver then gets behind the wheel of the vehicle. The first driver must have reported the minor defect **before the next circle check**.

Major defects

A major defect **must be entered in the circle check report and immediately reported to the operator**. A vehicle with a major defect is **prohibited from being driven or operated**.

Operators' responsibilities when a defect is reported

When operators receive a copy of a circle check report that includes a defect, they are required to:

- sign the copy of the circle check report;
- immediately inform the owner of the defect;
- send the owner a copy of the circle check report.

Owners' responsibilities when a defect is detected

Owners **must correct any defect of which they have been informed**.

• Minor defect

Owners have 48 hours to have the necessary repairs made in order to maintain the right to operate the vehicle.

• Major defect

The vehicle is prohibited from being operated as long as the necessary repairs have not been made.

■ Circle check report

What is a circle check report?

A circle check report is a document that allows the driver or the person designated by the operator to inform the operator of the results of the inspection and, if applicable, the defects detected. The report also attests to the validity of the circle check.

When must it be filled out?

The circle check report must be filled out during every circle check, even if no defects are detected.



I drive within a 160-km radius. Do I have to fill out a circle check report? **Yes, it is mandatory under all circumstances.**

Who fills out the circle check report?

The **person who performs the circle check** must fill out the circle check report and enter his or her observations.

Where must it be kept?

Keeping the **completed and valid** circle check report on board the vehicle is mandatory; the vehicle **cannot** be put into operation if this report is not on board the vehicle.

What are the operators' obligations?

- Operators must make sure that the person who performs the circle check **enters all the required information in the report.**
- They must make sure **that the driver keeps** the circle check report **on board the vehicle.**
- **They must not allow the vehicle to be operated** if the circle check report is not on board the vehicle.

What are the owners' obligations?

When a vehicle is used by an operator who is not the owner of the vehicle, the owner must obtain a copy of the circle check report.

What information must the circle check report contain?

The circle check report can be presented in various forms (a sample model is appended to this guide), but **must** contain the following information:

- the vehicle's licence plate number or the unit number found on the registration certificate;
- the operator's name;
- the date and time at which the circle check was performed;
- the municipality or location on the road where the circle check was performed;
- any defects noted during the trip;
- any defects noted during the circle check. If no defect was noted, this must be indicated as well;
- the name of the person who performed the circle check (printed legibly);
- a declaration, signed by the driver or the person who performed the circle check, attesting that the vehicle was inspected in accordance with applicable requirements;
- if the driver did not personally perform the circle check, his or her signature to attest that he or she read the report and accepted it;
- the odometer reading.



You should use the licence plate number if you are travelling outside Québec, as some jurisdictions do not accept the unit number.

Does it have to be kept up to date?

Drivers are required to keep the circle check report up to date. As soon as they note a defect during the trip, they must record it in the report.

When must the report be sent to the operator?

Drivers must send the original copy of the circle check report to the operator no later than 20 days after it is completed.

Does it have to be handed over to a peace officer?

Drivers are required to hand over the circle check report to any peace officer at his or her request.



Operating a heavy vehicle elsewhere in Canada

Québec carriers operating on the territories of other Canadian jurisdictions benefit from reciprocity as regards the circle check. Regulations in effect in Québec on this subject comply with National Safety Code (NSC) Standard 13 prescribed by the Canadian Council of Motor Transport Administrators.

There may, however, be some differences concerning minor and major defects, and it is the operator's responsibility to be aware of those differences.

Operating a heavy vehicle in the United States

Québec carriers operating in the United States benefit from reciprocity as regards daily inspections of heavy vehicles.

There may, however, be some differences concerning minor and major defects, and it is the operator's responsibility to be aware of those differences.

■ Keeping documents

Who must keep the documents?

Operators

For each heavy vehicle, operators are required to keep:

- a copy of circle check-related documents for at least six months.

Owners

For each heavy vehicle, owners are required to keep:

- a copy of circle check-related documents for at least six months;
- any documents attesting to the repair of defects for at least 12 months.



Some programs, such as the International Registration Plan (IRP), may require documents to be kept for longer periods.



Inspection Methods

■ What method should be used to perform the circle check?

The methods presented in this guide allow you to perform a circle check quickly, effectively and safely. However, there is no mandatory method.

What is important is to:

- choose a safe place on flat terrain;
- remain vigilant to avoid falls and injuries;
- adopt a position that provides you with a good view of the accessible components provided for in the circle check;
- remain attentive throughout the circle check to clues that may indicate a defect (e.g. traces of fluid on the ground, audible air leaks).

Using the same inspection routine may help you save time and make sure you don't forget anything.

Moreover, since the applicable list of defects must be kept on board the vehicle, drivers can use it as a checklist as they perform the circle check. Thus, the numbers that appear in parentheses in each of the following methods refer to the lists of defects and enable drivers to identify minor or major defects.

■ What material should be used to perform the circle check?

- A flashlight;
- A clean rag;
- A hammer.



■ Example of the inspection method for a semi-trailer hitched to a tractor truck (List 1)

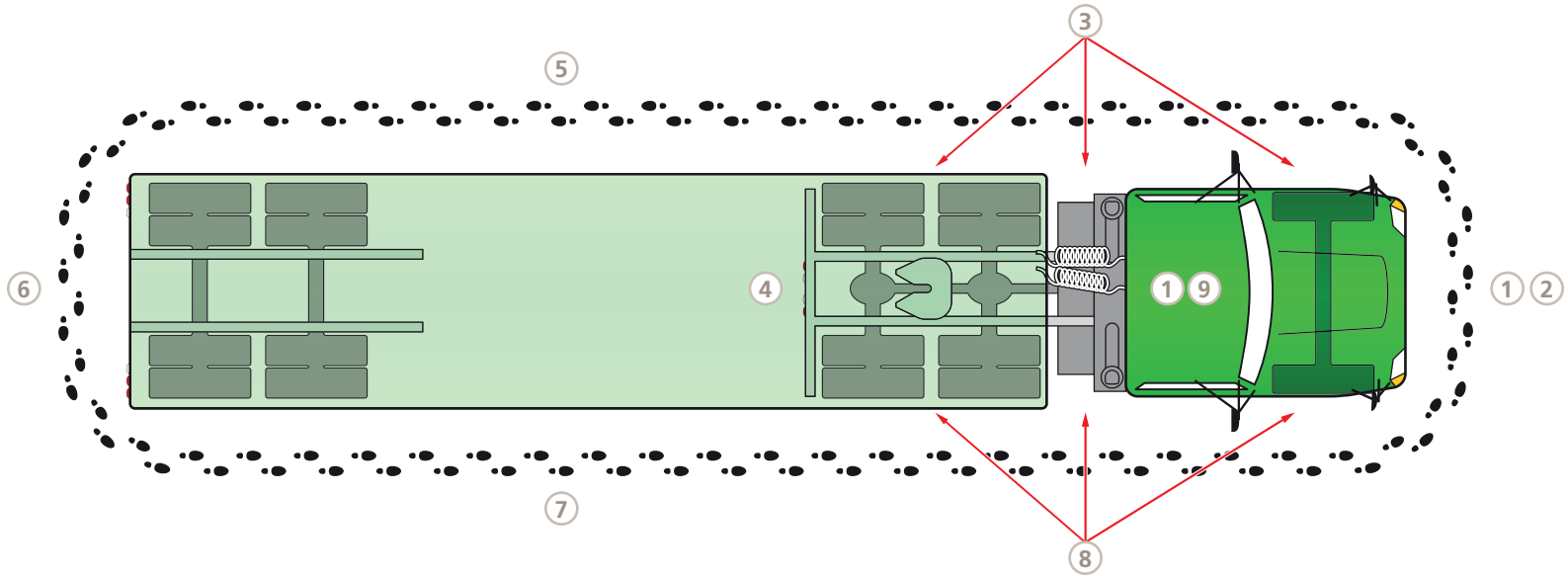

1. Approaching the vehicle and preliminary inspections in the cab

Before getting on board:

Check the general condition of the vehicle combination to detect any signs of defects (fluid on the ground, sagging vehicle, non-parallel wheels, displaced axle, air leak, missing body component, etc.).

On board the tractor truck:

Make sure the parking brake is engaged. Switch on the low beams, the parking lights and the right turn signal light (flasher).

- Check whether the driver's side door can be opened and closed (10.1, 10.A).

Exit the vehicle.

2. Tractor truck – front

As you move toward the front of the vehicle, unlatch the hood on the left side and position yourself facing the vehicle to check:

- the fixed components of the body (2.2);
- front outside rearview mirrors (11.3);
- the low beams (8.1, 8.A);
- the parking lights (8.1);⁵
- the right turn signal light (flasher) (8.1).

Unlatch the hood on the right side, go back to the front and raise the hood.

3. Tractor truck – left (driver's) side

At the left front of the tractor truck and under the hood, check:

- the power steering fluid level (5.2);
- the power steering pump belt (if applicable) (5.3);

- the side rail (2.1, 2.A, 2.B);
- the suspension* (Section 14);
- the tire and valve (Section 9);
- the wheel and its fasteners (12.B, 12.C);
- the wheel bearing lubricant (12.1, 12.A).

* Make sure air is being supplied to the vehicle's suspension.

On the left side of the tractor truck, check:

- the fixed components of the body (2.2);
- the left side rearview mirror (11.2, 11.3);
- the exhaust system (16.1);
- the side rail and the cross member (if it is visible) (2.1, 2.A, 2.B);
- the fuel tank (leaks and mountings) (15.A, 15.C);
- the gas or diesel filler cap (15.B).

5. Front parking lights are only mandatory on vehicles 2.03 m wide or less.





At the left rear of the tractor truck, check:

- the fixed components of the body (2.2);
- the exhaust system (if applicable) (16.1);
- the coupling mechanism (fifth wheel) (1.1, 1.B, 1.C, 1.D, 1.E, 1.F);
- the coupling plate and the kingpin – visible parts (if applicable) (1.A, 1.F);
- the side rails and cross members of the tractor truck and the semi-trailer (2.1, 2.A, 2.B);
- the suspension* (Section 14);
- the tires and valves (Section 9);
- the wheels and their fasteners (12.B, 12.C);
- the wheel bearing lubricant (12.1, 12.A).

* Make sure air is being supplied to the vehicle's suspension

4. Tractor truck – rear

At the rear of the tractor truck, check:

- the fifth wheel jaws (use the flashlight, if need be) (1.E, 1.F);
- the coupling plate and the kingpin – visible parts (if applicable) (1.A, 1.F);
- the tractor truck's parking lights (8.1);

- the tractor truck's right turn signal light (flasher) (8.1);
- the fixed components of the body (2.2).

From this location, you can also take a look at the parts that were difficult to see earlier, such as the suspension, side rails, cross members, exhaust system components or the tires. In addition, by looking to the rear, you can see the trailer's cross members.

5. Semi-trailer – left (driver's) side

On the left side of the semi-trailer, from front to rear, check:

- the fixed components of the body (2.2);
- the semi-trailer's side rails and cross members (2.1, 2.A, 2.B);
- the support or mounting holding the spare wheel (if the semi-trailer is so equipped) (12.2).

Facing the semi-trailer's rear wheels, check:

- the side rail and the locking pins of the sliding bogie (if the semi-trailer is so equipped) (2.1, 2.A, 2.B, 2.C);
- the suspension* (Section 14);
- the tires and valves (Section 9);
- the wheels and their fasteners (12.B, 12.C);
- the wheel bearing lubricant (12.1, 12.A).

* Make sure air is being supplied to the vehicle's suspension.

Go to the rear of the semi-trailer.

6. Semi-trailer – rear

At the rear of the semi-trailer, check:

- the parking lights (8.1, 8.B);
- the right turn signal light (flasher) (8.1, 8.B);
- the licence plate light (8.1);
- the fixed components of the body (2.2);

- the side rails and cross members (2.1, 2.A, 2.B);
- the suspension* (Section 14).

If some parts were not accessible or visible during Step 5, take advantage of this position to check them.

* Make sure air is being supplied to the vehicle's suspension.

7. Semi-trailer – right (passenger) side

Facing the semi-trailer's rear wheels, check:

- the side rail and locking pins of the sliding bogie (if the semi-trailer is so equipped) (2.1, 2.A, 2.B, 2.C);
- the suspension* (Section 14);
- the tires and valves (Section 9);
- the wheels and their fasteners (12.B, 12.C);
- the wheel bearing lubricant (12.1, 12.A).

* make sure air is being supplied to the vehicle's suspension.

On the right side of the semi-trailer, from rear to front, check:

- the fixed components of the body (2.2);
- the semi-trailer's side rails and cross members (2.1, 2.A, 2.B);
- the support and mounting holding the spare wheel (if the semi-trailer is so equipped) (12.2).

8. Tractor truck – right (passenger) side

At the right rear of the tractor truck, check:

- the fixed components of the body (2.2);
- the exhaust system (if applicable) (16.1);
- the coupling mechanism (fifth wheel) (1.1, 1.B, 1.C, 1.D, 1.F);
- the coupling plate and the kingpin – visible parts (if applicable) (1.A, 1.F);
- the side rails and cross members of the tractor truck and the semi-trailer (2.1, 2.A, 2.B);
- the suspension* (Section 14);
- the tires and valves (Section 9);

- the wheels and their fasteners (12.B, 12.C);
- the wheel bearing lubricant (12.1, 12.A).

* Make sure air is being supplied to the vehicle's suspension.

From the right side of the tractor truck, check:

- the fixed components of the body (2.2);
- the right rearview mirror (11.2, 11.3);
- the passenger side door (10.A);
- the exhaust system (16.1);
- the side rails and cross members (2.1, 2.A, 2.B);
- the fuel tank (leaks and mountings) (15.A, 15.C);
- the gas or diesel filler cap (15.B).





At the right front of the tractor truck and under the hood, check:

- the side rail (2.1, 2.A, 2.B);
- the suspension* (Section 14);
- the tire and valve (Section 9);
- the wheel and its fasteners (12.B, 12.C);
- the wheel bearing lubricant (12.1, 12.A).

* Make sure air is being supplied to the suspension.

Move to the front, close and latch the hood. Go back inside the cab to activate the left turn signal (flasher), exit the cab and check:

- the left turn signal (flasher) at the front and rear of the tractor truck as well as the rear of the semi-trailer (8.1, 8.B);

Go back inside the cab.

9. Tractor truck – inside the cab (driver's compartment)

- Adjust the driver's seat to the desired position, as needed (13.1);

Check:

- the presence of emergency material (7.1, 7.2);⁶
- the seat belt (13.A);
- the rearview mirrors (11.2, 11.3);
- the windshield (11.1);
- the side windows on each side of the driver's compartment (11.1);
- the windshield wipers (6.1, 6.A);
- the windshield washer system (6.2);
- the windshield blower (3.1);
- the steering wheel (5.1, 5.A);
- the steering column (5.1, 5.A);
- the horn (4.2).

Make sure the vehicle is stable.

Inspections related to the pneumatic brake system are identified in blue in the text below.

START THE ENGINE and RELEASE THE PARKING BRAKE.

Check:

- **the low pressure warning devices (19.1, 19.2, 19.A)**

If the low pressure warning devices are not already in operation, pump the brake pedal a few times to lower the air pressure in order to determine, using the pressure gauge, the air pressure at which the warning devices (buzzer, light, visual) are activated. They must activate before the air pressure in the system drops to less than 380 kPa (55 psi).

If the low pressure warning devices are in operation when the vehicle is started, this check can be carried out without further lowering the pressure. You must make sure that the air pressure is equal to or above 380 kPa (55 psi) when the warning devices switch off.

6. The vehicle must be equipped with at least three lamps, three reflectors or three flares, failure of which constitutes an offence.

- **the performance of the compressor (14.B, 19.B)**

While the engine is idling and the air compressor is operating, fully depress the brake pedal and keep it fully depressed. Watch the pressure gauge and make sure the compressor can reach and maintain air pressure of at least 620 kPa (90 psi).

- **the pressure regulator (stopping the compressor) (19.3)**

While the air compressor is still in operation, let the engine run and make sure the compressor switches off when the air pressure is between 805 kPa (117 psi) and 945 kPa (137 psi).

During this step, the engine can be run at a slightly higher RPM (approximately 1,000 RPM) in order to increase the air pressure a little more quickly.

STOP THE ENGINE and check:

- **for leaks and the pressure in the brake system (19.4, 19.C)**

Press on the brake pedal and keep it depressed while checking for air leaks (visible on the pressure gauge or audible).

RESTART THE ENGINE and check:

- **the pressure regulator (starting the compressor) (19.3)**

While watching the pressure gauge, slowly lower the air pressure until the compressor switches back on. Make sure it switches on before the air pressure reaches 550 kPa (80 psi).

Continue with the following inspections:

- the accelerator (4.1, 4.A);
- **the semi-trailer's parking brake (engaging and releasing) (19.5);**
- **the tractor truck's parking brake (engaging and releasing) (19.5);**
- the clutch control mechanism (if the vehicle is equipped with a manual transmission) (4.1);
- the power steering (5.B);
- **the service brake (19.D):**
 - apply the semi-trailer's parking brake.
 - With the transmission in neutral, press on the accelerator without reaching the maximum RPM, and release the accelerator to make sure the engine returns to idle.

- Try to delicately move the vehicle forward by shifting the transmission into a forward gear (or the highest gear that lets you move the vehicle forward in the case of a manual transmission, e.g. by shifting into third gear). Make sure the parking brake maintains the vehicle stationary.
- Apply the tractor truck's parking brake and release the semi-trailer's parking brake.
- Try to once again to delicately move the vehicle forward. Make sure the parking brake maintains the vehicle stationary.
- Release the tractor truck's parking brake.
- Completely release the clutch pedal in the case of a manual transmission, or shift into forward gear in the case of an automatic transmission.
- Drive forward slightly while turning the steering wheel to one side then the other to make sure that all the wheels turn freely and that the power steering is operating properly.
- Press on the clutch pedal (if applicable) and the brake pedal to stop the vehicle. This will allow you to make sure the service brake is working properly, as well as the clutch in the case of a manual transmission.





Shift the transmission back into neutral, apply the parking brake and check:

- the engine's exhaust system (exhaust gases infiltrating the cab if there are holes in the floorboard) (16.A);
- the brake lights of both the tractor truck and the semi-trailer when safe installations allow you to do so or with the assistance of a second person (8.1, 8.B).

Fill out the circle check report.



If your vehicle is equipped with drum brakes with self-adjusting brake levers, a simple procedure allows you to make sure that the play compensation or the space between the brake linings and the drum is optimal. To follow this procedure, when the brakes are cold, you must:

1. Release the parking brakes.
2. Bring the system up to maximum air pressure (120 psi).
3. Fully depress the brake pedal for five seconds and then release it completely.
4. Carry out this procedure four or five times in a row to ensure the play compensation is complete.

■ Example of the inspection method for a school bus (equipped with hydraulic brakes) (List 2)

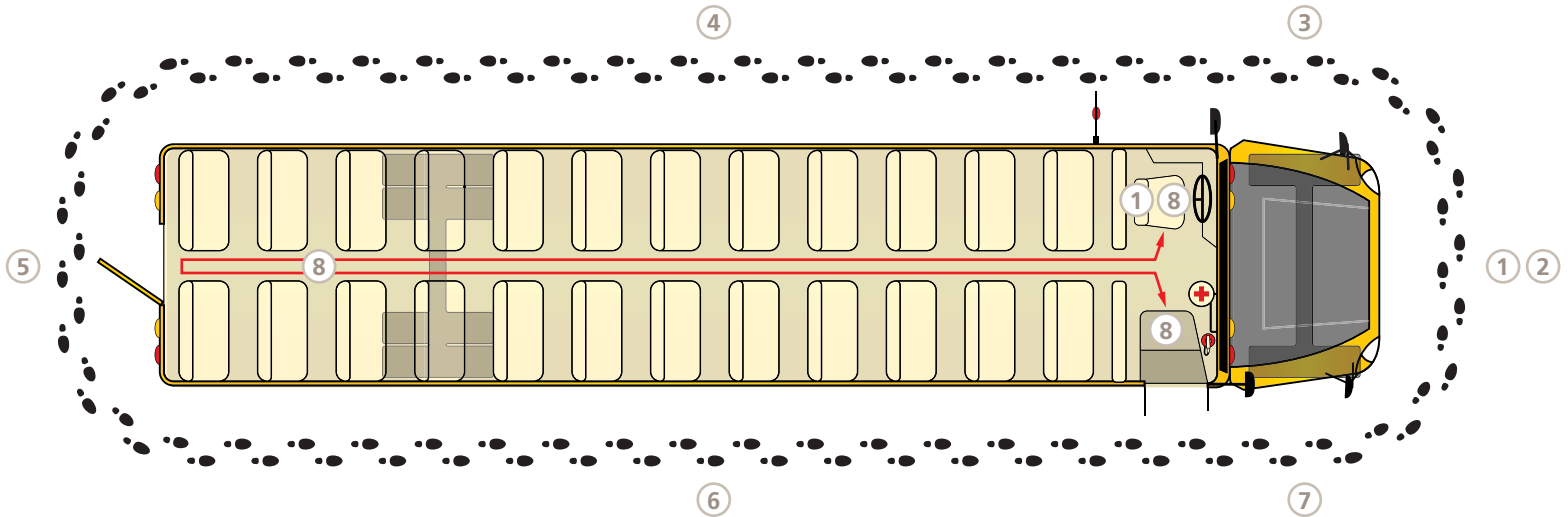



1. Approaching the vehicle and preliminary inspections in the vehicle

Before getting on board:

Check the general condition of the school bus to detect any signs of defects (fluid on the ground, sagging vehicle, non-parallel wheels, displaced axle, air leak, missing body component, etc.).

On board:

Make sure the parking brake is engaged. Switch on the low beams, the parking lights, the central aisle and passenger access lighting and the right turn signal (flasher). Switch on the flashing red lights and the retractable stop sign, as well as the alternately flashing yellow lights.

- Check to make sure the driver's door opens and closes (10.1, 10.A).

Exit the bus.

2. In front of the bus

Go to the front of the vehicle, unlatch the hood on the right side and position yourself facing the vehicle to check:

- the flashing red lights (20.8);
- the front-mounted outside rearview mirrors (11.2, 11.3);
- the low beams (8.1, 8.A);
- the parking lights (8.1);⁷
- the right turn signal (flasher) (8.1);
- the fixed components of the body (2.2).

Unlatch the left side of the hood, then go back to the front and open it.

3. Left front (driver's side)

Move towards the left front wheel and check under the hood, from top to bottom:

- the power steering fluid level (5.2);
- the power steering pump belt (if applicable) (5.3);

- the fluid level in the master cylinder reservoir (18.1, 18.A);
- the side rail (2.1, 2.A, 2.B);
- the suspension (Section 14);
- the tire and valve (Section 9);
- the wheel and its fasteners (12.B, 12.C);
- the wheel bearing lubricant (12.1, 12.A).

4. Left side (front to back)

Check:

- the left rearview mirror (11.2, 11.3);
- the retractable stop sign (20.7);
- the alternately flashing lights (on the stop sign) (20.7);
- the fixed components of the body (2.2);
- the outside doors of luggage or auxiliary compartments (if applicable) (2.3);
- the side rails and cross members (2.1, 2.A, 2.B);
- the exhaust system (16.1);
- the suspension (Section 14);
- the tires and valves (Section 9);

7. The parking lights are only mandatory on vehicles 2.03 m wide or less.

- the wheels and their fasteners (12.B, 12.C);
- the wheel bearing lubricant (12.1, 12.A).

Go to the rear of the bus.

5. At the rear of the bus

Facing the rear, check:

- the flashing red lights (20.8);
- the parking lights (8.1, 8.B);
- the right turn signal (flasher) (8.1, 8.B);
- the brake lights (if possible) (8.1, 8.B);
- the licence plate light (8.1);
- the fixed components of the body (2.2);
- the coupling mechanism (if applicable) (1.1, 1.2, 1.C, 1.F)
- the exhaust system (16.1).

6. Right side (rear to front)

Check:

- the fixed components of the body (2.2);
- the side rails and cross members (2.1, 2.A, 2.B);
- the suspension (Section 14);
- the tires and valves (Section 9);
- the wheels and their fasteners (12.B, 12.C);
- the wheel bearing lubricant (12.1, 12.A);
- the exhaust system (16.1);
- the outside doors of the luggage or auxiliary compartments (if applicable) (2.3);
- the fuel tank (leaks and mountings) (15.A, 15.C);
- the gas or diesel filler cap (15.B);
- the right rearview mirror (11.2, 11.3).

7. Right front (passenger access door side)

Under the hood, check:

- the side rail (2.1, 2.A, 2.B);
- the suspension (Section 14);
- the tire and valve (Section 9);
- the wheel and its fasteners (12.B, 12.C);
- the wheel bearing lubricant (12.1, 12.A).

Move towards the front, close the hood and latch the left side, then the right side.

8. Inside the bus

Climb on board the vehicle and check:

- the steps of the passenger compartment (20.3);
- the presence of emergency material (7.1, 7.2);⁸
- the central aisle and passenger access lighting (20.4).

Close the door.

8. The vehicle must be equipped with at least three emergency triangle reflectors, failure of which is an offence.





Switch on the alternately flashing yellow lights and the left turn signal (flasher).

As you go to the rear, check:

- the guard panels (20.1);
- the side windows immediately behind the driver's compartment (11.4);
- the overhead (top) luggage racks in the passenger compartment (20.5);
- the emergency side exits (accessibility only) (10.B);
- the emergency door (10.B, 10.C).

Open the rear emergency door and check:

- the emergency door warning buzzer (10.C);
- the rear alternately flashing yellow lights (20.8);
- the left turn signal (flasher) (8.1, 8.B).

Close the emergency door and, as you make your way back to the front, check:

- the passenger seats or benches (20.6);
- the floor (20.3).

Sit in the driver's compartment and:

- adjust the driver's seat to the desired position (13.1).

Check:

- the seat belt (13.A);
- the front alternately flashing yellow lights, using the rearview mirrors (20.8);
- the left turn signal (flasher), using the rearview mirrors (8.1);
- the outside rearview mirrors (11.2, 11.3);
- the windshield (11.1);
- the windshield wipers (6.1, 6.A);
- the windshield washer system (6.2);
- the windshield blower (3.1);
- the steering wheel (5.1, 5.A);
- the steering column (5.1, 5.A);
- the horn (4.2);
- the side windows on each side of the driver's compartment (11.1).

Make sure the vehicle is stable.

Inspections related to the hydraulic brake system (hydraulic power brakes) are identified in blue in the text below.

Check:

- the working condition of the service brake warning light (18.3);
- the working condition of the hydraulic power brake boost (18.C);
- leakage and pressure in the braking equipment (18.2, 18.B);
 - Make sure the ignition switch is in the "ON" position and that the parking brake is released (only if the service brake warning light is the same as the parking brake warning light).
 - Check whether the service brake warning light is on.
 - Apply medium pressure on the brake pedal and listen to hear if the electric pump is working.
 - Apply medium pressure on the brake pedal and listen for the sound of the power brake electric pump.

- Maintain medium pressure on the brake pedal for at least 10 seconds.
- Check whether the brake pedal pushes all the way to the floor or if you have to pump it several times before getting any pressure in the lines, which can be felt by resistance in the pedal's movement.
- Start the engine.
- Check whether the service brake warning light comes off.

Continue with the following inspections:

- the parking brake warning light (18.4);
- the accelerator (4.1, 4.A);
- the parking brake (18.5);
- the clutch control mechanism (in the case of a manual transmission) (4.1);
- the power steering (5.B);
- the service brake (18.D):
 - Apply the parking brake.
 - Check whether the parking brake warning light comes on.

- With the transmission in neutral, press on the accelerator without reaching maximum RPM, and release the accelerator to make sure the engine returns to idle.
- Try to delicately move the vehicle forward by shifting the transmission into a forward gear (or the highest gear that lets you move the vehicle forward in the case of a manual transmission, e.g. by shifting into third gear). Make sure the parking brake maintains the vehicle stationary.
- Release the parking brake and check whether the warning light comes off.
- Drive forward slowly (by delicately and completely releasing the clutch pedal in the case of a manual transmission) and check to make sure the wheels are turning freely.
- Turn the steering wheel to one side then the other to make the wheels move to make sure that the power steering is operating properly.
- Press on the clutch pedal (if applicable) and the brake pedal to stop the vehicle. This will allow you to make sure the service brake is working properly, as well as the clutch in the case of a manual transmission.

Continue with the following inspections:

- the engine's exhaust system (exhaust gases infiltrating into the passenger compartment if there are holes in the floorboard) (16.A);
- the brake lights (where safe installations allow you to do so or with the assistance of a second person) (8.1, 8.B).

Fill out the circle check report.





■ Example of the inspection method for a motor coach (List 3)

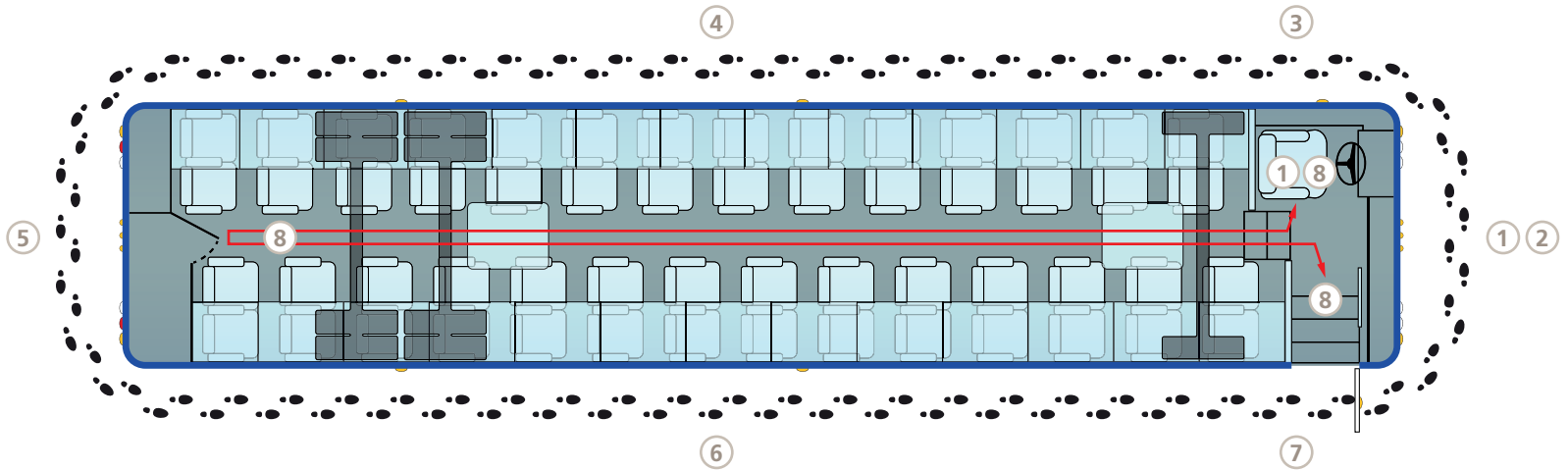

1. Approaching the vehicle and preliminary inspections in the driver's compartment

Before getting on board:

Check the general condition of the motor coach to detect any signs of defects (fluid on the ground, sagging vehicle, non-parallel wheels, displaced axle, air leak, missing body component, etc.).

On board:

Make sure the parking brake is engaged. Switch on the low beams, the parking lights, the central aisle and passenger access lighting and the right turn signal (flasher).

- Check to make sure the driver's door opens and closes (10.1, 10.A).⁹

Exit the motor coach.

2. In front of the motor coach

Check:

- the right rearview mirror (11.2, 11.3);
- the low beams (8.1, 8.A);
- right turn signal (flasher) (8.1);
- the fixed components of the body (2.2);
- the outside doors of the luggage or auxiliary compartments (if applicable) (2.3);
- the left rearview mirror (11.2, 11.3).

3. Left front (driver's side)

Move towards the left front wheel of the vehicle and check, from top to bottom:

- the suspension* (Section 14);
- the tire and valve (Section 9);
- the wheel and its fasteners (12.B, 12.C);
- the wheel bearing lubricant (12.1, 12.A).

* Make sure air is being supplied to the vehicle's suspension.

4. Left side (front to back)

Check:

- the fixed components of the body (2.2);
- the outside doors of the luggage or auxiliary compartments (2.3);
- the fuel tank (leaks and mountings) (15.A, 15.C);
- the gas or diesel filler cap (15.B);
- the suspension* (Section 14);
- the tires and valves (Section 9);
- the wheel and its fasteners (12.B, 12.C);
- the wheel bearing lubricant (12.1, 12.A).

* Make sure air is being supplied to the vehicle's suspension.

Go to the rear of the motor coach.

9. For an optimal inspection, the opening and closing of the doors should be checked once the air reservoirs have been supplied with air.





5. At the rear of the motor coach

Facing the rear, check:

- the fixed components of the body (2.2);
- the parking lights (8.1, 8.B);
- the right turn signal (flasher) (8.1, 8.B);
- the brake lights (if possible) (8.1, 8.B);
- the licence plate light (8.1);
- the coupling mechanism (if applicable) (1.1, 1.2, 1.C, 1.F).

Open the engine seat and check:

- the power steering fluid level (5.2);
- the power steering pump belt (if applicable) (5.3);
- the exhaust system (16.1).

Close the engine compartment.

6. Right side (rear to front)

Check:

- the fixed components of the body (2.2);
- the outside doors of the luggage or auxiliary compartments (2.3);
- the suspension* (Section 14);
- the tires and valves (Section 9);
- the wheels and their fasteners (12.B, 12.C);
- the wheel bearing lubricant (12.1, 12.A);
- the fuel tank (leaks and mountings) (15.A, 15.C);
- the gas or diesel filler cap (15.B).

* Make sure air is being supplied to the vehicle's suspension.

7. Right front (passenger access door side)

Check:

- the suspension* (14.2, 14.B, 14.G);
- the tire and valve (Section 9);
- the wheel and its fasteners (12.B, 12.C);
- the wheel bearing lubricant (12.1, 12.A).

* Make sure air is being supplied to the vehicle's suspension.

Go back inside the motor coach to switch on the left turn signal (flasher), then go back outside to check:

- the front and rear turn signal (flasher) (8.1, 8.B).

8. Inside the motor coach

Go back inside the motor coach and check:

- the steps of the passenger compartment (20.3);
- the presence of emergency material (7.1, 7.2).¹⁰

As you go to the rear, check:

- the central aisle and passenger access lighting (20.4);
- the horizontal bars and guard panels (20.1, 20.2);
- the overhead (top) luggage racks in the passenger compartment (20.5);
- the emergency exits (accessibility only) (10.B).

As you make your way back to the front, check:

- the passenger seats or benches (20.6);
- the floor (20.3).

Sit in the driver's seat and:

- adjust the driver's seat to the desired position (13.1).

Check:

- the seat belt (13.A);
- the outside rearview mirrors (11.2, 11.3);
- the windshield (11.1);
- the windshield wipers (6.1, 6.A);
- the windshield washer system (6.2);
- the windshield blower (3.1);
- the steering wheel (5.1, 5.A);
- the steering column (5.1, 5.A);
- the horn (4.2);
- the side windows on each side of the driver's compartment (11.1).

Make sure the vehicle is stable.

Inspections related to the pneumatic brake system are identified in blue in the text below.

START THE ENGINE and RELEASE THE PARKING BRAKE.

Check:

- **the low pressure warning devices (19.1, 19.2, 19.A)**

If the low pressure warning devices are not already in operation, pump the brake pedal a few times to lower the air pressure in order to determine, using the pressure gauge, the air pressure at which the warning devices (buzzer, light, visual) are activated. They must activate before the air pressure in the system drops to less than 380 kPa (55 psi).

If the low pressure warning devices are in operation when the vehicle is started, this check can be carried out without further lowering the pressure. You must make sure that the air pressure is equal to or above 380 kPa (55 psi) when the warning devices switch off.

- **the performance of the compressor (14.B, 19.B)**

While the engine is idling and the air compressor is operating, fully depress the brake pedal and keep it fully depressed. Watch the pressure gauge and make sure the compressor can reach and maintain air pressure of at least 620 kPa (90 psi).

¹⁰. The vehicle must be equipped with at least three lamps, three reflectors or three flares, failure of which constitutes an offence.





- **the pressure regulator (stopping the compressor) (19.3)**

While the air compressor is still in operation, let the engine run and make sure the compressor switches off when the air pressure is between 805 kPa (117 psi) and 945 kPa (137 psi).

During this step, the engine can be run at a slightly higher RPM (approximately 1,000 RPM) in order to increase the air pressure a little more quickly.

STOP THE ENGINE and check:

- **for leaks and the pressure in the brake system (19.4, 19.C)**

Press on the brake pedal and keep it depressed while checking for air leaks (visible on the pressure gauge or audible).

RESTART THE ENGINE and check:

- **the pressure regulator (starting the compressor) (19.3)**

While watching the pressure gauge, slowly lower the air pressure until the compressor switches back on. Make sure it switches on before the air pressure reaches 550 kPa (80 psi).

Continue with the following inspections:

- the accelerator (4.1, 4.A);
- **the parking brake (engaging and releasing) (19.5);**
- the clutch control mechanism (if the vehicle is equipped with a manual transmission) (4.1);
- the power steering (5.B);
- **the service brake (19.D):**
 - apply the parking brake.
 - With the transmission in neutral, press on the accelerator without reaching the maximum RPM, and release the accelerator to make sure the engine returns to idle.
 - Try to delicately move the vehicle forward by shifting the transmission into a forward gear (or the highest gear that lets you move the vehicle forward in the case of a manual transmission, e.g. by shifting into third gear). Make sure the parking brake maintains the vehicle stationary.
 - Release the parking brake.

- Drive forward slowly (by delicately and completely releasing the clutch pedal in the case of a manual transmission) and check to make sure the wheels are turning freely.
- Turn the steering wheel to one side then the other to make the wheels move to make sure that the power steering is operating properly.
- Press on the clutch pedal (if applicable) and the brake pedal to stop the vehicle. This will allow you to make sure the service brake is working properly, as well as the clutch in the case of a manual transmission.

Shift the transmission back into neutral, apply the parking brake and check:

- the engine's exhaust system (exhaust gases infiltrating the cab if there are holes in the floorboard) (16.A);
- the brake lights when safe installations allow you to do so or with the assistance of a second person (8.1, 8.B).

Fill out the circle check report.

If your vehicle is equipped with drum brakes with self-adjusting brake levers, a simple procedure allows you to make sure that the play compensation or the space between the brake linings and the drum is optimal. To follow this procedure, when the brakes are cold, you must:

1. Release the parking brakes.
2. Bring the system up to maximum air pressure (120 psi).
3. Fully depress the brake pedal for five seconds and then release it completely.
4. Carry out this procedure four or five times in a row to ensure the play compensation is complete.



Circle Check (Mechanical Component)

38



■ Introduction

During the circle check, you must carry out a sight and sound inspection of the accessible components identified in the list of defects that applies to the vehicle you are using. These lists, which include all of the systems and mechanical parts to inspect, are appended to this document.

Systems

Each system (coupling, steering, etc.) is designated by a colour and a number. This number corresponds to the one that appears in the list of defects. Thus, system "1. Coupling Devices" of the mechanical component corresponds to the first system that appears on each of the three lists; system "2. Frame and Cargo Body" corresponds to the second system, etc.

Summary tables

The presentation of each system begins with a table that summarizes the following points:

Parts covered

Parts covered by the circle check.

Defects

The minor and major defects that may affect the parts covered. A number code (e.g. 1.1) corresponds to a minor defect, whereas an alphanumeric code (e.g. 1.A) corresponds to a major defect. Areas shaded in grey means that there are no defects affecting the part covered by the inspection.

Vehicles subject to a circle check

If an "X" appears in a column, this part must be inspected for the vehicle to which the list applies. If the space is shaded in grey, there are no parts to inspect.

Photos and illustrations

Photos and illustrations have been added as examples to make everything easier to understand.

Circle check report

Lastly, a sample circle check report is appended to this guide. This document attests to the validity of the circle check and is used to inform the operator of the results of the inspection and, if applicable, any defects that have been detected.



■ List of Systems

1. Coupling Devices
2. Frame and Cargo Body
3. Heater/Defroster
4. Driver Controls
5. Steering
6. Windshield Wiper/Washer
7. Emergency Material
8. Headlights and Lights
9. Tires
10. Doors and Other Openings
11. Glass and Mirrors
12. Wheels, Hubs and Fasteners
13. Seat
14. Suspension
15. Fuel System
16. Exhaust System
17. Electric Brake System
18. Hydraulic Brake System
19. Pneumatic Brake System
20. Passenger Transport

1 | Coupling Devices

This section concerns all types of coupling devices (fifth wheel, hook and ring, gooseneck, ball and hitch, etc.).





Parts Covered	Minor Defects 	Major Defects 	Vehicles Covered			
			List 1 	List 2 	List 3 	
Fixed or sliding fifth wheel coupling device (see Figures 1 and 2)	Fifth wheel fasteners (nuts and bolts)	1.1	1.C	X		
	Sliding fifth wheel locking pins		1.D	X		
	Components of the fifth wheel (lower coupling plate, mounting angles, jaws, support)		1.F	X		
	Upper coupling plate and kingpin		1.A 1.F	X		
	Fifth wheel jaws and the jaw locking mechanism indicator		1.E 1.F	X		

FIGURE 1 | Fifth wheel



FIGURE 2 | Coupling plate and kingpin







	Parts Covered	Minor Defects 	Major Defects 	Vehicles Covered		
				List 1 	List 2 	List 3 
Hook and ring coupling device (see Figure 3)	Hook and ring fasteners (e.g. nuts and bolts)	1.1	1.C	X	X	X
	Components of the coupling device (drawbar ring, pintle hook)		1.F	X	X	X
	Safety fasteners and their coupling components (e.g. steel cables, chains, hooks, rings to which the chains must be attached, etc.)	1.2		X	X	X

FIGURE 3 | Hook and ring







Parts Covered	Minor Defects 	Major Defects 	Vehicles Covered			
			List 1 	List 2 	List 3 	
Other coupling devices, e.g. gooseneck, ball and hitch (see Figures 4 and 5)	Coupling device fasteners (e.g. nuts and bolts)	1.1	1.C	X	X	X
	Components of the coupling device (e.g. ball, hitch)		1.F	X	X	X
	Safety fasteners and their coupling components (e.g. steel cables, chains, hooks, rings to which the chains must be attached, etc.)	1.2		X	X	X

FIGURE 4 | Gooseneck



FIGURE 5 | Ball and hitch



Fixed or Sliding Fifth Wheel Coupling Device



Parts Covered and How to Inspect Them

Fifth wheel fasteners (nuts and bolts)

On both sides of the vehicle, facing the fifth wheel

Inspect the mounting angle and check for the presence and condition of the nuts and bolts that fasten the fifth wheel to the vehicle frame (see Figures 6 and 7, page 44).



Minor Defects

1.1 When the vehicle is hitched, 20% or less of the parts fastening the fifth wheel to the tractor frame are missing, broken or loose on an anchorage.*



* The notion of 20% must be applied individually to each anchorage.



EXAMPLE of a minor defect: 2 out of a total of 10 bolts are broken on the anchorage on the left side (= 20%) and 2 out of a total of 10 bolts are loose on the anchorage on the right side (= 20%).

1.1 When the vehicle is unhitched, one or more parts fastening the fifth wheel are missing, broken or loose.



Major Defects

1.C When the vehicle is hitched, more than 20% of the parts fastening the fifth wheel to the vehicle frame are missing, broken or loose on an anchorage.*



EXAMPLE of a major defect: 1 bolt is loose and 2 bolts are broken out of a total of 10 bolts on the same anchorage.

1.C When the vehicle is hitched, there is some movement between a fifth wheel fastener (mounting angle) and the vehicle's frame.



Fixed or Sliding Fifth Wheel Coupling Device

FIGURE 6 | Fifth wheel fasteners

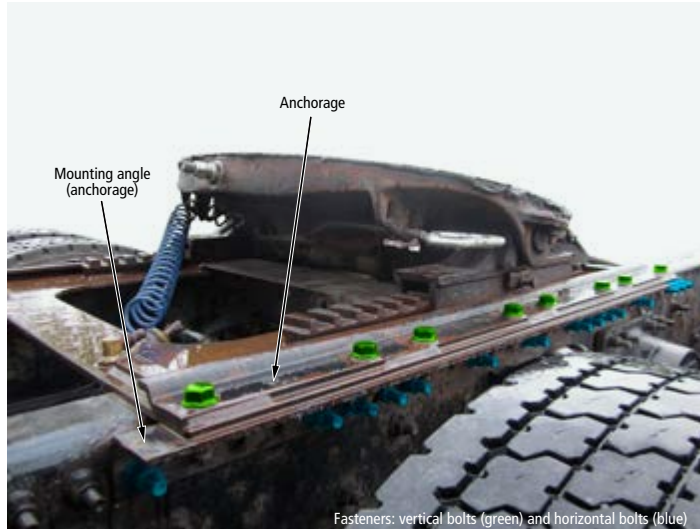
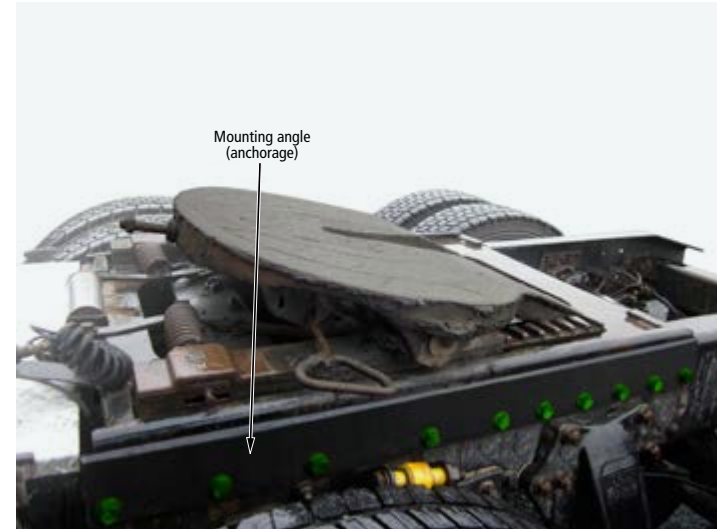

FIGURE 7 | Fifth wheel fasteners



Fixed or Sliding Fifth Wheel Coupling Device



Parts Covered and How to Inspect Them

Sliding fifth wheel locking pins

On both sides of the vehicle facing the sliding fifth wheel

- Check for the presence of the locking pins.
- Make sure the pins are in the locked position.



Minor Defects



Major Defects

1.D When the vehicle is hitched, 25% or more of the locking pins of a sliding fifth wheel are missing or inoperative (see Figure 8).



Some fifth wheels have 2 locking pins and others have 4. In these cases, there is a major defect as soon as one locking pin is missing or inoperative, as the 25% threshold will have been reached.

FIGURE 8 | The fifth wheel locking pin is inoperative because it is not in the locked position.



Fixed or Sliding Fifth Wheel Coupling Device



Parts Covered and How to Inspect Them

Components of the fifth wheel (e.g. lower coupling plate, mounting angles, jaws, support)

On both sides of the vehicle, facing the fifth wheel

- Inspect the visible parts of the fifth wheel components (see Figure 9).



Minor Defects



Major Defects

1.F When the vehicle is hitched, a component of the fifth wheel is cracked, bent or deteriorated* to the point that there is a risk of breakage or separation from the combination of vehicles.

* For example, broken or worn.

FIGURE 9 | Components of the fifth wheel

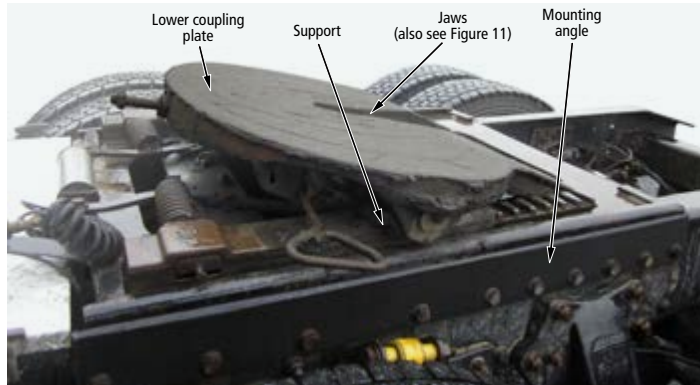

Fixed or Sliding Fifth Wheel Coupling Device



Parts Covered and How to Inspect Them

Upper coupling plate and kingpin

On both sides of the semi-trailer, facing the fifth wheel

- Inspect the visible parts of the upper coupling plate and kingpin underneath the semi-trailer.



Minor Defects



Major Defects

- 1.A** The coupling plate or kingpin is so bent that it adversely affects hitching, or is cracked or improperly secured.
- 1.F** **When the vehicle is hitched**, the coupling plate or kingpin is deteriorated* to the point that there is a risk of breakage or separation from the combination of vehicles.

* For example, broken or worn.

FIGURE 10 | Upper coupling plate and kingpin



Fixed or Sliding Fifth Wheel Coupling Device



Parts Covered and How to Inspect Them

Fifth wheel jaws and the jaw locking mechanism indicator

Behind the tractor truck (under the semi-trailer when the vehicle is hitched)

- Using a flashlight, inspect the fifth wheel jaws to make sure they are properly closed (see Figure 11).

On the side of the vehicle, facing the fifth wheel

- Inspect the locking mechanism indicator (bolt located in front of the fifth wheel) and check the position of the locking handle(s) (see Figure 12).



Minor Defects



Major Defects

- 1.E When the vehicle is hitched,** the jaws are not completely closed behind the kingpin.
- 1.F When the vehicle is hitched,** the jaw locking mechanism is not engaged.

Fixed or Sliding Fifth Wheel Coupling Device

FIGURE 11 | Fifth wheel jaws

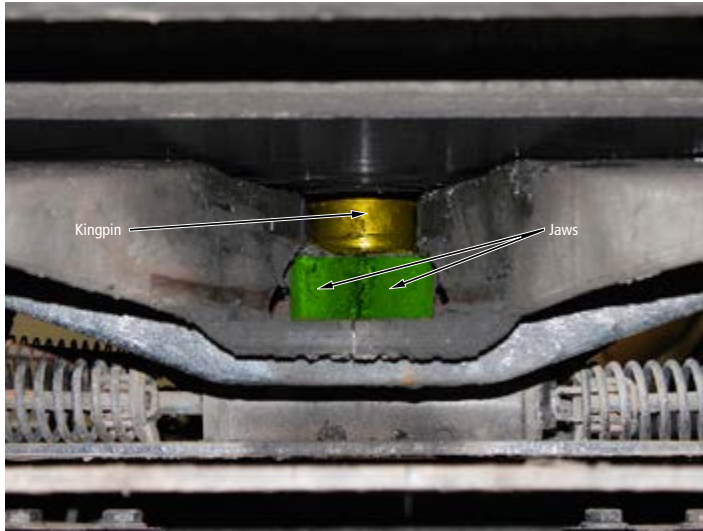
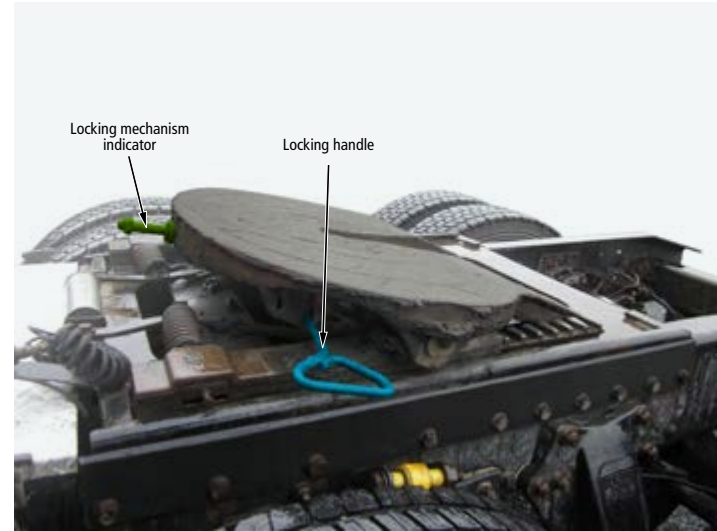

FIGURE 12 | Fifth wheel (locking mechanism indicator and locking handle)



Hook and Ring Coupling Device



Parts Covered and How to Inspect Them

Hook and ring fasteners (e.g. nuts and bolts)

On both sides of the combination of vehicles

- Inspect the parts that attach the hook and ring to the vehicles (see Figure 13).



Minor Defects

1.1 When the vehicles are unhitched, one or more of the fasteners are missing, broken or loose.

1.1 When the vehicles are hitched, 20% or less of the fasteners that attach the coupling device to the vehicle are missing, broken or loose.



Major Defects

1.C When the vehicles are hitched, more than 20% of the fasteners that attach the coupling device to the vehicle are missing, broken or loose.

FIGURE 13 | Hook and ring fasteners



Hook and Ring Coupling Device



Parts Covered and How to Inspect Them

Components of the coupling device (drawbar ring, pintle hook)

On both sides of the combination of vehicles

- Inspect the coupling device on the tractor vehicle (e.g. pintle hook, pintle hook locking mechanism) and the trailer (e.g. drawbar ring).

Important! A converter dolly uses two types of coupling devices: a fifth wheel and a pintle hook/drawbar ring. Both must be checked (see Figure 14).



Minor Defects



Major Defects

1.F When the vehicles are hitched, a component of the coupling device is missing, not securely mounted, cracked, bent or deteriorated* to the point that there is a risk of breakage or separation of the combination of vehicles.

* For example, broken or worn.



A missing or inoperative pintle hook locking mechanism is a major defect, as there is a risk of separation of the combination of vehicles.

FIGURE 14 | Converter dolly



Hook and Ring Coupling Device



Parts Covered and How to Inspect Them

Safety fasteners and their coupling components (e.g. steel cable, chain, hook, ring to which the chain must be attached)

Between the tractor vehicle and the trailer

- Inspect the safety fasteners and coupling components (see Figure 15).



Minor Defects

1.2 A safety fastener or a coupling component is missing, deteriorated* or improperly attached.

* For example, broken or worn.



Under the *Highway Safety Code*, safety fasteners and their coupling components are mandatory when the trailer is not equipped with emergency brakes that enable the trailer to be stopped in the event of separation.



Major Defects

FIGURE 15 | Safety fasteners and their coupling components



Other Coupling Devices (e.g. gooseneck, ball and hitch)



Parts Covered and How to Inspect Them

Coupling device fasteners (e.g. nuts and bolts)

On both sides of the combination of vehicles

- Inspect the parts that attach the coupling device to the vehicle (see Figures 16 and 17).



Minor Defects

1.1 When the vehicles are unhitched, one or more of the fasteners are missing, broken or loose.

1.2 When the vehicles are hitched, 20% or less of the fasteners that attach the coupling device to the vehicle are missing, broken or loose.



Major Defects

1.C When the vehicles are hitched, more than 20% of the fasteners that attach the coupling device to the vehicle are missing, broken or loose.

FIGURE 16 | Gooseneck coupling device

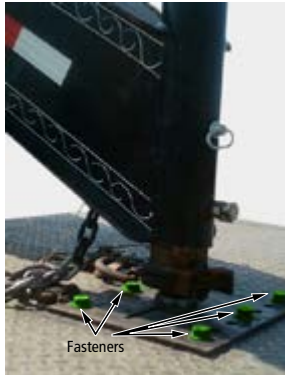
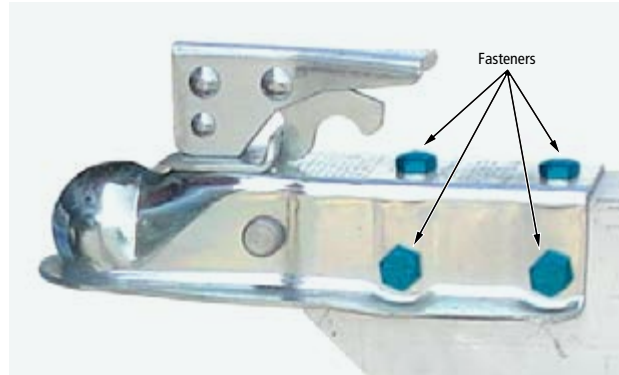

FIGURE 17 | Ball and hitch coupling device



Other Coupling Devices (e.g. gooseneck, ball and hitch)



Parts Covered and How to Inspect Them

Components of the coupling device (e.g. ball, hitch)

On both sides of the combination of vehicles

- Inspect the coupling device on the tractor vehicle and the trailer.

Safety fasteners and their coupling components (e.g. steel cable, chain, hook, ring to which the chain must be attached)

Between the tractor vehicle and the trailer

- Inspect the safety fasteners and coupling components (see Figure 15, page 52).



Minor Defects

1.2 A safety fastener or a coupling component is missing, deteriorated* or improperly attached.

* For example, broken or worn.



Under the *Highway Safety Code*, safety fasteners and their coupling components are mandatory when the trailer is not equipped with emergency brakes that enable the trailer to be stopped in the event of separation.



Major Defects

1.F When the vehicles are hitched, a component of the coupling device is missing, not securely mounted, cracked, bent or deteriorated* to the point that there is a risk of breakage or separation of the combination of vehicles.

* For example, broken or worn.



A coupling device locking mechanism that is missing or inoperative is a major defect as there is a risk of separation of the combination of vehicles.

2 | Frame and Cargo Body





Parts Covered	Minor Defects 	Major Defects 	Vehicles Covered		
			List 1 	List 2 	List 3 
Side rails and cross members	2.1	2.A 2.B	X	X	
Locking pins that secure a sliding bogie under the semi-trailer		2.C	X		
Fixed components of the body	2.2		X	X	X
Outside doors of the luggage compartments and auxiliary compartments	2.3			X	X

FIGURE 18 | Frame (side rails and cross members)

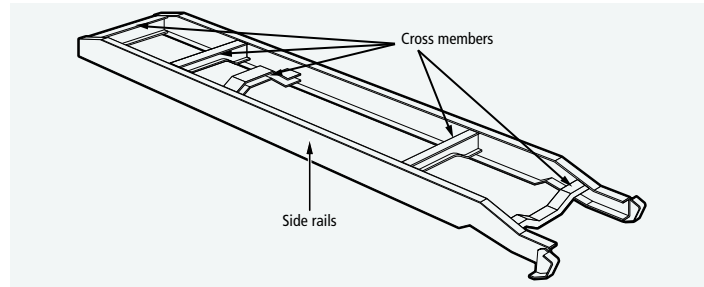
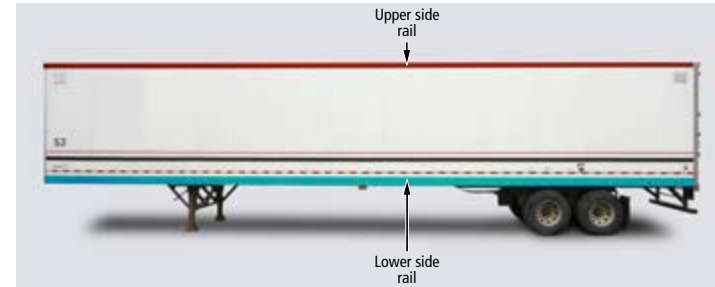

FIGURE 19 | Monocoque frame





Parts Covered and How to Inspect Them

Side rails and cross members

Around the vehicle or combination of vehicles

- Inspect the visible sections of the side rails and cross members (see Figure 20).



Minor Defects

- 2.1 The side rail web is cracked.
- 2.1 The side rail flange is cracked.
- 2.1 A cross member is cracked or broken.



Major Defects

- 2.A A side rail is in danger of breaking.
- 2.B A side rail or cross member sags and makes a moving part* come into contact with the body.

* For example, tires, wheels, steering or suspension components.

FIGURE 20 | Side rail and cross member

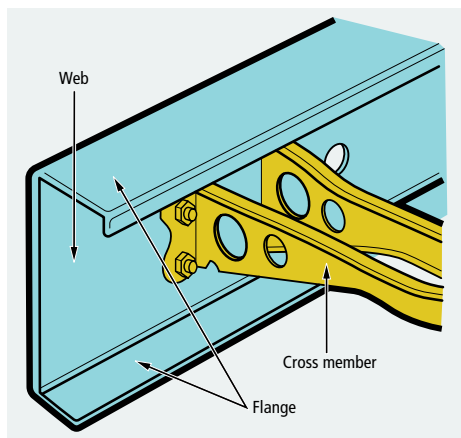

✓ **Parts Covered and How to Inspect Them**

Locking pins that secure a sliding bogie under the semi-trailer

Outside the vehicle, on both sides of the semi-trailer's wheels

- Make sure the locking pins are present and in the locked position (see Figure 21).

! **Minor Defects**

✋ **Major Defects**

2.C More than 25% of the locking pins are missing **or** not in the locked position.

FIGURE 21 | Sliding bogie

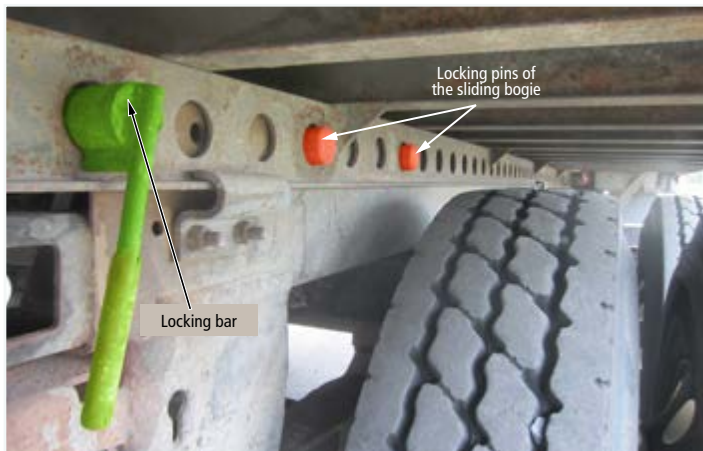



Parts Covered and How to Inspect Them

Fixed components of the body

Around the vehicle

- Inspect the fixed components of the body such as the body panels, fenders and bumpers.



Minor Defects

- 2.2** A fixed component of the body is missing or improperly mounted.



Major Defects

THIS SECTION ONLY APPLIES TO BUSES AND MOTOR COACHES

Outside doors of the luggage compartments and auxiliary compartments

Around the vehicle

- Inspect the doors of the luggage compartments and auxiliary compartments*, if the vehicle is so equipped.

* An auxiliary compartment is a compartment in which, for example, tools or vehicle maintenance equipment can be stored.

- 2.3** An outside door of a luggage compartment or auxiliary compartment is inadequate* or improperly mounted to the road vehicle.

* An outside door of a luggage compartment or auxiliary compartment is inadequate when it does not close or is not in proper working order.

3 | Heater/Defroster

The windshield blower is the component that must be checked in this section.





Parts Covered	Minor Defects 	Major Defects 	Vehicles Covered		
			List 1 	List 2 	List 3 
Windshield blower	3.1		X	X	X

FIGURE 22 | Blower controls





Parts Covered and How to Inspect Them

Windshield blower

In the driver's compartment

- Switch on the blower and direct the air flow toward the windshield.
- Check whether the air blows onto the windshield.



Only the components provided by the manufacturer are covered by this inspection. Auxiliary systems, such as fans installed in buses, are not concerned.



Minor Defects

3.1 The windshield blower does not work.

Since it is the working order of the windshield blower that must be checked by the driver during the circle check, it is not necessary to run the engine and wait for the air to warm up for this inspection.







It should be noted, however, that under section 265 of the *Highway Safety Code*, the windshield must be free of any material that may reduce visibility for the driver (e.g. fog, snow, frost).



Major Defects

4 | Driver Controls

The brake pedal is covered in Sections 17, 18 and 19.

Parts Covered	Minor Defects 	Major Defects 	Vehicles Covered		
			List 1 	List 2 	List 3 
Accelerator	4.1	4.A	X	X	X
Clutch	4.1		X	X	X
Horn	4.2		X	X	X



Parts Covered and How to Inspect Them

Accelerator

In the driver's compartment

- Make sure the parking brake is engaged, the transmission is in neutral (N) and that the engine is running.
- Press on the accelerator (but not to maximum RPM).
- Release the accelerator.
- Make sure the engine returns to idle by watching the tachometer or, in the absence of a tachometer, by listening to the sound of the engine.



Minor Defects

- 4.1** The engine does not accelerate or does not return to idle in a normal manner when the accelerator is released.



Major Defects

- 4.A** The engine does not return to idle after the accelerator is released.



Parts Covered and How to Inspect Them

Clutch

Manual (standard) transmissions only

In the driver's compartment

- Make sure the parking brake is engaged.
- Make sure the transmission is in neutral (N).
- Press on the clutch pedal and start the engine.
- Put the gearshift lever into a gear (forward).
- Release the parking brake.
- Let the vehicle move forward by delicately and completely releasing the clutch pedal.
- Press the clutch pedal once again and apply the brakes to stop the vehicle.
- Shift the transmission into neutral and apply the parking brake.

Note: This inspection can be carried out at the same time as the parking brake release check.



Minor Defects

4.1 The clutch mechanism is not in proper working order.



Major Defects





Parts Covered and How to Inspect Them

Horn

In the driver's compartment

- Activate the horn.



Minor Defects

4.2 The horn does not work.









If the vehicle is equipped with two horns, the driver is required to check at least one of them.



Major Defects

5 | Steering

Parts Covered	Minor Defects 	Major Defects 	Vehicles Covered		
			List 1 	List 2  	List 3 
Power steering pump reservoir	5.2		X	X	X
Power steering pump belt	5.3		X	X	X
Power steering		5.B	X	X	X
Steering column	5.1	5.A	X	X	X
Steering wheel	5.1	5.A	X	X	X



✓ Parts Covered and How to Inspect Them

Power steering pump reservoir

In the engine compartment

- Check the fluid level in the power steering pump reservoir (see Figure 23).



If you have to open the power steering reservoir because the fluid level cannot be checked from the exterior, take certain precautions to avoid introducing any contaminants into the fluid.

! Minor Defects

- 5.2** The fluid level in the reservoir is lower than the minimum level or higher than the maximum level prescribed by the manufacturer.



This inspection can be carried out by checking the gauge or the indicators on the reservoir.

✋ Major Defects

FIGURE 23 | Power steering pump reservoir





Parts Covered and How to Inspect Them

Power steering pump belt

In the engine compartment

- Inspect the power steering pump belt if the vehicle is equipped with one and if it is accessible (see Figure 24).



Minor Defects

5.3 The power steering pump belt is cut.



Most heavy vehicles are not equipped with a belt-driven power steering pump.



Major Defects

FIGURE 24 | Power steering pump belts

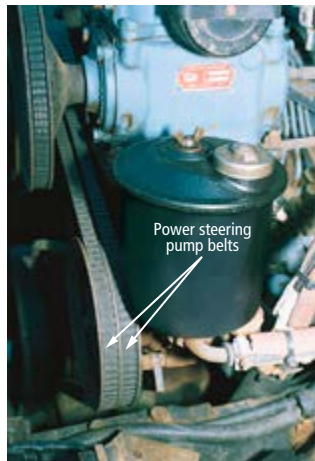

✓ Parts Covered and How to Inspect Them

Power steering

In the driver's compartment, while the engine is running

- Turn the steering wheel from side to side so as to move the wheels.



For certain types of vehicles, it may be necessary for the vehicle to move forward slightly to check the power steering.

Steering column

In the driver's compartment

- Try to move the steering wheel in all directions (see Figure 25).



Minor Defects

- 5.1** The steering column moves from its normal position.



Major Defects

- 5.B** The power steering does not work.



A steering wheel that is difficult to turn may be a sign that the power steering is not working.

- 5.A** The steering column moves from its normal position and there is a risk of separation.

FIGURE 25 | Steering column



Parts Covered and How to Inspect Them

Steering wheel

In the driver's compartment

- Try to move the steering wheel in all directions (solidity).
- If the steering wheel's position is adjustable, make sure it remains in the set position.



Minor Defects

- 5.1** The adjustable steering wheel does not remain in the set position.









Major Defects

- 5.A** The steering wheel moves from its normal position because it is improperly mounted on the steering column and there is a risk of separation.

6 | Windshield Wiper/Washer

These defects must be taken into account at all times, not only in bad weather.

Parts Covered	Minor Defects 	Major Defects 	Vehicles Covered		
			List 1 	List 2  	List 3 
Windshield wipers	6.1	6.A	X	X	X
Windshield washer system	6.2		X	X	X



Parts Covered and How to Inspect Them

Windshield wipers

In the driver's compartment

- Check for the presence of windshield wipers.
- Switch on the wipers.
- Check the effectiveness of the wiper blades.

Windshield washer system

In the driver's compartment

- Switch on the windshield washer system.
- Check whether the windshield washer system sprays washer fluid onto the windshield.



It is recommended that the driver make sure to always have enough washer fluid before taking a vehicle out on the road. The driver can take advantage of the time taken to carry out the outside inspections to check the windshield washer fluid level. Some vehicles are even equipped with a low washer fluid warning light.



Minor Defects

- 6.1** The wiper on the passenger's side:
- is missing;
 - is not working;
 - does not sweep the windshield effectively.
- 6.2** The windshield washer system does not clean the windshield effectively (for example, the washer fluid spray nozzle is improperly adjusted or blocked, or little or no washer fluid sprays out when the spray is activated).









Major Defects

- 6.A** The wiper on the driver's side:
- is missing;
 - is not working;
 - does not sweep the windshield effectively.



7 | Emergency Material

Parts Covered	Minor Defects 	Major Defects 	Vehicles Covered		
			List 1 	List 2 	List 3 
Flares, triangle reflectors or lamps (where required by law or regulation)*	 Not subject to a defect, but an offence		Wider than 2 m	Wider than 2 m and other regulations*	Wider than 2 m
First aid kit and its mountings (where required by law or regulation)**	7.1		X	X	X
Chemical fire extinguisher and its mountings (where required by law or regulation)**	7.2		X	X	X

* Examples of legislation in effect requiring flares, triangle reflectors or lamps (see Figures 26, 27 and 28):

- The *Highway Safety Code* requires that a vehicle wider than 2 m be equipped with flares, reflectors or lamps.
- The *Regulation respecting vehicles used for the transportation of school children* requires school buses to be equipped with at least three triangle reflectors in proper working order.
- The *Regulation respecting road vehicles adapted for the transportation of handicapped persons* requires vehicles to be equipped with at least three red emergency lamps or reflectors or three fluorescent triangles.

** Examples of legislation in effect requiring a first aid kit or a chemical fire extinguisher:

- The *Regulation respecting vehicles used for the transportation of school children*
- The *Transportation of Dangerous Substances Regulation*
- The *Regulation respecting road vehicles adapted for the transportation of handicapped persons*

✓ Parts Covered and How to Inspect Them

**Flares, triangle reflectors or lamps
(where required by law or regulation)**

Inside the vehicle

- Make sure there are at least three flares, three triangle reflectors or three lamps (see Figures 26, 27 and 28).

! Minor Defects

⚖ Not subject to a defect but an offence.

🚫 Major Defects

FIGURE 26 | Triangle reflectors



FIGURE 27 | Flares



FIGURE 28 | Lamps



Parts Covered and How to Inspect Them

First aid kit and its mountings (where required by law or regulation)

Inside the vehicle

- Make sure the kit is accessible and securely attached.



Checking the contents of the first aid kit is not required as part of the circle check, but is required by other regulations.

Chemical fire extinguisher and its mountings (where required by law or regulation)

Inside the vehicle

- Make sure the extinguisher is accessible and securely attached.
- Read the pressure gauge.

Minor Defects

7.1 The first aid kit is not securely mounted or difficult to access.

7.2 The chemical fire extinguisher is not securely mounted, inadequate* or difficult to access.

* A chemical extinguisher is inadequate when it is not equipped with a pressure gauge or on which the pressure gauge indicates "Refill" or "Zero".

Major Defects

8 | Headlights and Lights

Lights that are specific to school buses, namely the flashing red lights, the alternately flashing yellow lights and the flashing lights on the stop sign, are presented in Section 20.





Parts Covered	Minor Defects 	Major Defects 	Vehicles Covered		
			List 1 	List 2 	List 3 
Low beams	8.1	8.A	X	X	X
Parking lights (front and rear)	8.1	8.B	X	X	X
Turn signal lights (flashers)	8.1	8.B	X	X	X
Brake lights	8.1	8.B	X	X	X
Rear licence plate light	8.1		X	X	X



FIGURE 29 | Headlights and front lights of a truck

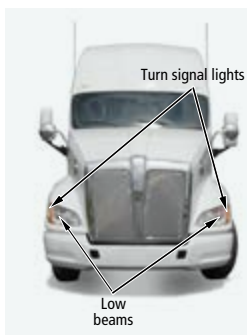

FIGURE 30 | Rear lights of a truck



FIGURE 31 | Rear lights of a semi-trailer



FIGURE 32 | Headlights and front lights of a school bus

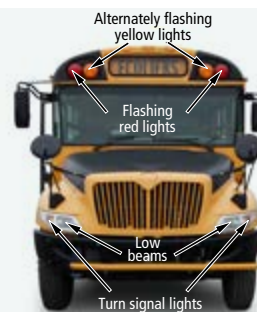

FIGURE 33 | Rear lights of a school bus

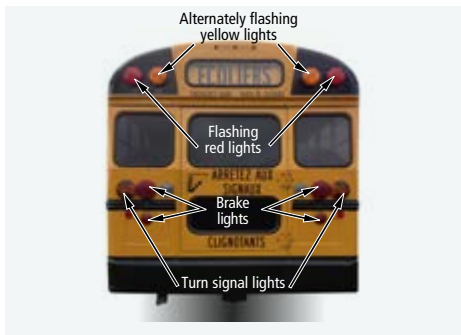

FIGURE 34 | Headlights and front lights of a motor coach

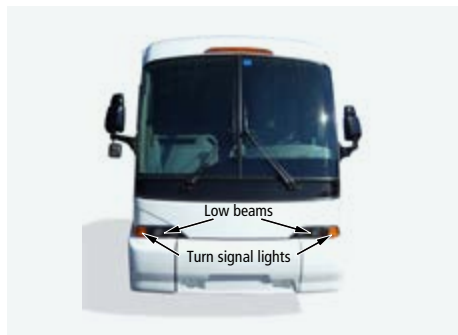
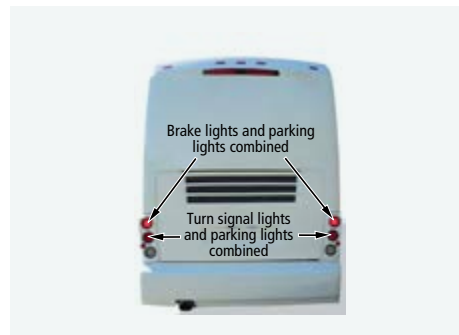

FIGURE 35 | Rear lights of a motor coach





Parts Covered and How to Inspect Them

Low beams¹

In the driver's compartment

- Switch on the low beams (see Figures 29, 32 and 34, page 76).

Outside the vehicle

- Check the front right and front left low beams.



Make sure the high beams are not activated to do this check.



Minor Defects

8.1 One of the low beams does not work.



Major Defects

8.A None of the low beams work.

1. A vehicle complies with the *Highway Safety Code* if it is equipped with one right front white headlight and one left front white headlight.





Parts Covered and How to Inspect Them

Parking lights²⁻³

In the driver's compartment

- Switch on the parking lights (see Figures 30, 31, 33 and 35 on page 76, and Figure 36 below).

Outside the vehicle

- Check the vehicle's front and rear parking lights. For a combination of vehicles, check these lights for every vehicle.



Minor Defects

- 8.1** For a single-unit vehicle, **one** of the rear parking lights does not work.
- 8.1** **When the vehicle is hitched**, one or both of the rear parking lights do not work for the tractor vehicle or the first semi-trailer of a double road train or one of the parking lights does not work for the last vehicle.
- 8.1** One or both **front** parking lights **do not work**.



Major Defects

- 8.B** **None** of the rear parking lights work for a single-unit vehicle or the last vehicle in a combination of vehicles.

FIGURE 36 | Front parking lights of a vehicle that is 2.03 m wide or less.



2. Front parking lights are only mandatory on vehicles that are 2.03 m wide less.
3. A vehicle complies with the *Highway Safety Code* if it is equipped with one right rear parking light and one left rear parking light.



Parts Covered and How to Inspect Them

Turn signal lights (flashers)⁴

In the driver's compartment

- Switch on the turn signal lights on one side and the other (see Figures 29 to 35, page 76).

Outside the vehicle

- Check the vehicle's front and rear turn signal lights. In the case of a combination of vehicles, the turn signal lights of each vehicle have to be checked.



Minor Defects

- 8.1** One or both of the **front** turn signal lights do not work.
- 8.1** **When the vehicle is hitched**, one or both of the rear turn signal lights on the tractor vehicle or the first semi-trailer of a double road train do not work.



Major Defects

- 8.B** On a single-unit vehicle or the last vehicle of a combination of vehicles:*
- none of the rear right turn signal lights work;
 - none of the rear left turn signal lights work.
- * This defect only applies to single-unit vehicles with a GVWR of 4,500 kg or more and the last vehicle in a combination of vehicles if that vehicle has a GVWR of 4,500 kg or more.

4. A vehicle complies with the *Highway Safety Code* if it is equipped with a front right turn signal light, a front left turn signal light, a rear right turn signal light and a rear left turn signal light.



✓ Parts Covered and How to Inspect Them

Brake lights⁵

In the driver's compartment

- Press on the brake pedal.
- Make sure the brake lights switch on (see Figures 30, 31, 33 and 35, page 76).

This inspection must only be carried out when it is safe to do so, for example with the help of another person or when installations allow the driver to see the reflection of the brake lights.

Rear licence plate light

At the rear of the vehicle or at the rear of the last vehicle of a combination of vehicles

- Check the licence plate light (see Figures 31, 33 and 35, page 76).

⚠ Minor Defects

8.1 For a single-unit vehicle, one of the brake lights does not switch on.

8.1 **When the vehicle is hitched**, one or both of the brake lights do not switch on for the tractor vehicle or the first semi-trailer of a double road train or one of the brake lights does not switch on for the last vehicle.

For a vehicle with two or more brake lights on each side, there is no defect if at least one of the lights on each side switches on.

8.1 The rear licence plate light does not work.

In the case of combination of vehicles, the last vehicle must be equipped with a white light located so as to illuminate the licence plate.

🚫 Major Defects

8.B None of the brake lights work for a single-unit vehicle or for the last vehicle of a combination of vehicles.

5. A vehicle complies with the *Highway Safety Code* if it is equipped with one right rear brake light and one left rear brake light.

9 | Tires

Only tires on a weight-bearing axle must be checked. Checking the tires on the auxiliary lift axle during the circle check is also recommended if there are plans to use them before the next circle check.





Parts Covered	Minor Defects 	Major Defects 	Vehicles Covered		
			List 1 	List 2 	List 3 
Grooves in the tread	9.1	9.A	X	X	X
Tread and sidewall	9.2 9.3 9.4	9.B 9.C 9.D	X	X	X
Tire valves	9.5		X	X	X



FIGURE 37 | Grooves in the tread

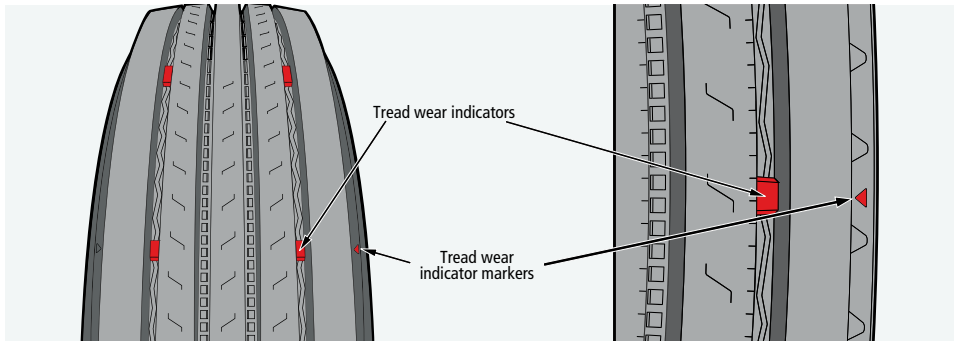

FIGURE 38 | Single tire



FIGURE 39 | Dual tires on single wheel assembly





Parts Covered and How to Inspect Them

Grooves in the tread

Around the vehicle

- Check the depth of the grooves in the tread (see Figure 37, page 82).

Tread and sidewall

Around the vehicle

- Check the general condition of the tires (wear, damage, presence of foreign material, bulging).

Note: Remember to inspect the tread on the entire visible part of the tire.

It may be difficult to see that one of the dual tires is flat when the second tire in the same wheel assembly is in good condition. Thus, to check whether one of the dual tires is flat, it is recommended to strike it with a hammer or similar object.



Minor Defects

All tires on a vehicle or combination of vehicles

- 9.1** A tire's tread wear indicator touches the roadway or the depth of a groove is equal to or less than the tread wear indicator.⁶

When one of the dual tires on the same wheel assembly shows:

- 9.2** Foreign material embedded in the tread or sidewall that could cause a puncture.
- 9.3** A cut, wear or any other damage that causes the cord or steel belt to be exposed.

For all tires:

- 9.4** A tire shows abnormal deformation (see Figure 40, page 84).



Major Defects

For a tire on the steering axle of a motor vehicle with a GVWR of 4,500 kg or more

- 9.A** The depth of two adjacent grooves is equal to or less than the tread wear indicator.⁶

When a single tire or both tires on the same wheel assembly show:

- 9.B** A foreign body embedded in the tread or sidewall that could cause a puncture.
- 9.C** A cut, wear or any other damage that causes the cord or steel belt to be exposed.

For all tires:

- 9.D** A tire touches a fixed component of the vehicle.

⁶ Considering that the tread wear indicator is set at 1.6 mm.



✓ Parts Covered and How to Inspect Them

! **Minor Defects**

9.4 The tread or rubber compound of the sidewall is separated from the carcass of a tire.

FIGURE 40 | Tire showing abnormal deformation



! **Major Defects**

9.D A tire shows an air leak or is flat.

9.D A tire shows a bulge related to a carcass defect (see Figure 41).

FIGURE 41 | Tire showing a bulge related to a carcass defect





Parts Covered and How to Inspect Them

Tire valves

Around the vehicle

- Check the condition of the tire valves.



Minor Defects





9.5 The tire valve is worn or damaged (e.g. scraped or cut).



Major Defects



10 | Doors and Other Openings

Parts Covered	Minor Defects 	Major Defects 	Vehicles Covered		
			List 1 	List 2 	List 3 
Cab doors	10.1	10.A	X	X	X
Emergency exits (doors, windows, roof hatch) and emergency door warning buzzer or light		10.B 10.C		X	X



Parts Covered and How to Inspect Them

Cab doors*

From outside and inside the vehicle

- Check whether the driver's side door opens and closes properly.
- Check whether all cab doors are completely engaged when they are closed.

* Only the doors designed to allow passengers to board and unboard the vehicle are covered. The sleeper berth doors are not included in this inspection.

It is only necessary to open and close the driver's side door. For the other cab doors, it is only necessary to make sure they are completely engaged.



If a door does not appear to be completely engaged, applying pressure on it may suffice to check whether it can engage completely. If in doubt, the door can be opened and closed again to make sure it engages completely.



Minor Defects

- 10.1** The driver's side door does not open or is difficult to open from both inside and outside the vehicle.



Major Defects

- 10.A** A cab door does not engage completely when it is closed.



THIS SECTION ONLY APPLIES TO BUSES AND MOTOR COACHES

✓ Parts Covered and How to Inspect Them

Emergency exits (doors, windows, roof hatch) and emergency door warning buzzer or light

Inside the vehicle

- Check whether the emergency exits are accessible.
- Open the emergency doors and make sure the warning buzzer or light is working.

! Minor defects

✋ Major defects

10.B An emergency exit is obstructed.



Any object or installation that hampers access to the emergency exit is considered an obstruction.

10.C An emergency door is inadequate or the warning buzzer or light is inoperative.



There is a major defect only when the warning buzzer or light of an **emergency door** is inoperative.

11 | Glass and Mirrors







Parts Covered	Minor Defects 	Major Defects 	Vehicles Covered		
			List 1 	List 2  	List 3 
Windshield	11.1		X	X	X
Side windows of the driver's compartment	11.1		X	X	X
Side windows on both sides of and directly behind the driver's compartment	11.4			School buses only	
Outside rearview mirrors	11.3		X	X	X
Mandatory outside rearview mirrors	11.2		X	X	X



FIGURE 42 | Rearview mirrors on a truck



FIGURE 43 | Rearview mirrors on a school bus



Parts Covered and How to Inspect Them

Windshield

In the driver's compartment

- Inspect the windshield and make sure its condition does not hamper the driver's vision of the road and road signs and signals.



Minor Defects

- 11.1** The windshield is tarnished, cloudy or broken in a way that reduces the driver's vision of the road or road signs and signals.



Major Defects



Parts Covered and How to Inspect Them

Side windows of the driver's compartment

In the driver's compartment

- Inspect the side windows on each side of the driver's compartment to make sure their condition does not hamper the driver's vision of the road and road signs and signals.



Minor Defects

- 11.1** A side window on either side of the driver's compartment is tarnished, cloudy, obstructed, crazed or cracked in a way that reduces the driver's vision of the road or road signs and signals.



Major Defects

THIS SECTION ONLY APPLIES TO SCHOOL BUSES AND MINIBUSES

Side windows on both sides of and directly behind the driver's compartment

Inside the vehicle

- Inspect the side windows on each side of and directly behind the driver's compartment to make sure their condition does not hamper visibility of the road and road signs and signals.

- 11.4** A side window on either side and directly behind the driver's compartment is tarnished, cloudy, obstructed, crazed or cracked in a way that reduces the driver's vision of the road or road signs and signals.



✓ Parts Covered and How to Inspect Them

Outside rearview mirrors

Outside the vehicle

- Inspect the mountings of all the rearview mirrors and make sure they do not show any sharp edges.

Mandatory outside rearview mirrors

Outside the vehicle and inside the driver's compartment

- Check whether the rearview mirrors are present and in good condition.
- Make sure that each mirror is adjusted for safe driving and that it remains in that position.

Mandatory rearview mirrors:

- Make sure a rearview mirror is mounted on the exterior on both sides of the vehicle.
- In addition, in the case of a school bus or minibus, make sure the vehicle is equipped with a front-mounted convex outside mirror on both sides of the vehicle.



The mandatory outside rearview mirrors require additional inspections.

! Minor Defects

For all outside rearview mirrors

11.3 An outside rearview mirror is not securely mounted or shows a sharp edge.*

- * A sharp edge means a pointed or cutting edge that could injure someone riding in the vehicle or a pedestrian.

For all mandatory outside rearview mirrors

11.2 A **mandatory** outside mirror is missing, broken, cracked or tarnished.

11.2 A **mandatory** outside mirror cannot be adjusted to the desired position or does not remain in the set position.

✋ Major Defects

12 | Wheels, Hubs and Fasteners

Only wheels on a weight-bearing axle must be checked. Inspecting the wheels on the auxiliary lift axle during the circle check is also recommended if there are plans to use them before the next circle check.







Parts Covered	Minor Defects 	Major Defects 	Vehicles Covered		
			List 1 	List 2  	List 3 
Wheels (discs, spokes and rims)		12.C	X	X	X
Wheel fasteners (bolts, wheel rim clamps, wheel studs and nuts)		12.B	X	X	X
Wheel bearings (lubricant level in the wheel hubs and seals)	12.1	12.A	X	X	X
Spare wheel support and fasteners	12.2		X	X	X



FIGURE 44 | Budd wheel



FIGURE 45 | Spoke wheel





Parts Covered and How to Inspect Them

Wheels (discs, spokes and rims)

Around the vehicle

- Check the condition of the visible parts of the wheels (discs, spokes and rims).

Wheel fasteners (bolts, wheel rim clamps, wheel studs and nuts)

Around the vehicle

- Check for the presence and condition of the wheel fasteners.



Adopt a position that allows you to check wheel fasteners that may be concealed by the wheel hub.



Minor Defects



Major Defects

- 12.C** A wheel is cracked, broken or shows an indication of repair or welding.
- 12.C** One of the stud holes is widened or oval-shaped.
- 12.B** A wheel fastener is missing, cracked, broken or not securely fixed.





Parts Covered and How to Inspect Them

Wheel bearings (lubricant level in the wheel hubs and seals)

Around the vehicle

- Check the lubricant level through the sight glass in the wheel hubs that are so equipped **without removing the filler cap** (see Figure 46, page 97).
- Check for any traces of oil or grease on the wheels or on the ground under the wheel hubs (e.g. caused by a defective seal).



Sight glasses are generally found on trailers and semi-trailers, as well as the wheels on the steering axle of a heavy vehicle.



Minor Defects

- 12.1** The wheel lubricant is below the minimum level when visible through a sight glass.

Regardless of whether the wheel hub is equipped with a sight glass

- 12.1** There is wheel bearing lubricant leakage other than sweating.

Important! Oil or grease leakage from the wheel hub indicates that the wheel bearings may not be sufficiently lubricated. Not enough oil or grease may cause the wheel to come off the vehicle. Be vigilant!



Major Defects

- 12.A** The wheel bearing lubricant is not visible through a sight glass.

Regardless of whether the wheel hub is equipped with a sight glass

- 12.A** The wheel bearing lubricant is absent.

FIGURE 46 | Wheel hub sight glass

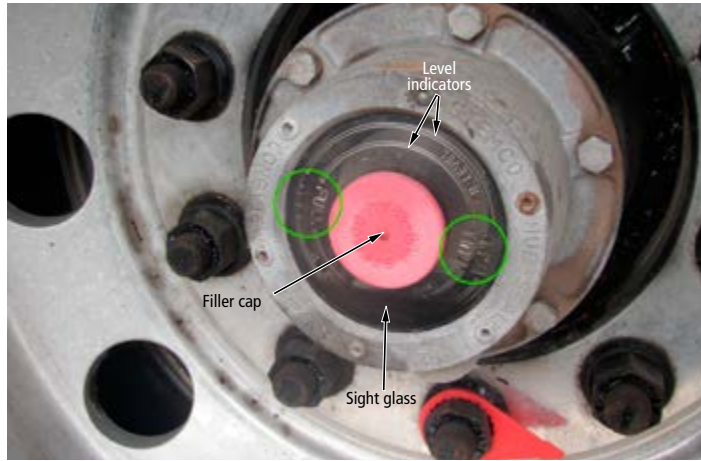

✓ Parts Covered and How to Inspect Them

Spare wheel support and fasteners

Outside the vehicle

- Inspect the **visible** parts of the spare wheel support and fasteners.

! Minor Defects





- 12.2** The spare tire support or fasteners cannot keep the spare wheel solidly fixed.

✋ Major Defects



13 | Seat

This section only concerns the driver's seat. The seats and benches in a bus or motor coach are presented in Section 20 of this guide.

Parts Covered	Minor Defects 	Major Defects 	Vehicles Covered		
			List 1 	List 2 	List 3 
Driver's seat	13.1		X	X	X
Driver's seat belt (anchorage, buckle, retractor and locking mechanism)		13.A	X	X	X



Parts Covered and How to Inspect Them

Driver's seat

In the driver's compartment

- Check the general condition of the seat.
- Make the necessary adjustments for safe driving, **if required**.
- Make sure the seat remains locked in position.

Driver's* seat belt (anchorage, buckle, retractor and locking mechanism)

In the driver's compartment

- Check for the presence, condition and operation of the seat belt.

* Some vehicles were originally equipped with seat belts that only have a lap belt and no shoulder belt.



Minor Defects

13.1 The driver's seat is inadequate* or does not remain locked in position.

* A seat is inadequate if it is not in proper working order to the point of being unsafe.



Major Defects





13.A The driver's seat belt is missing, modified or inadequate.*

* A seat belt is inadequate if it is not in proper working order.



14 | Suspension

It is important that you position yourself in such a manner as to view as many parts as possible for an efficient inspection of the suspension.

Parts Covered	Minor Defects 	Major Defects 	Vehicles Covered		
			List 1 	List 2 	List 3 
U-bolts mounting the axle to the vehicle and components for positioning the axle or wheel to the road vehicle		14.C	X	X	X
		14.G			X
Leaf springs, coil springs and torsion bars	14.1	14.A 14.D 14.E 14.F	X	X	
Rubber pads		14.A	X	X	
Lines and air springs in the pneumatic suspension system	14.2	14.B	X	X	X



Inspecting the suspension on the auxiliary lift axle during the circle check is recommended if there are plans to use it before the next circle check.

METAL OR COMPOSITE SPRING SUSPENSION

FIGURE 47 | Leaf spring

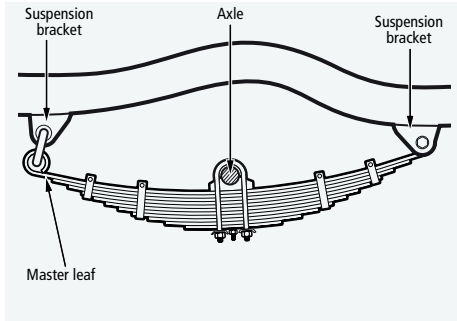

FIGURE 48 | Coil spring

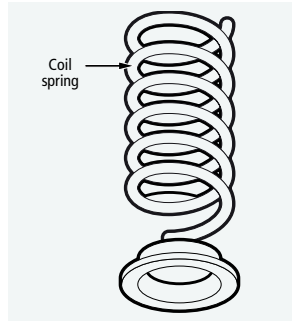
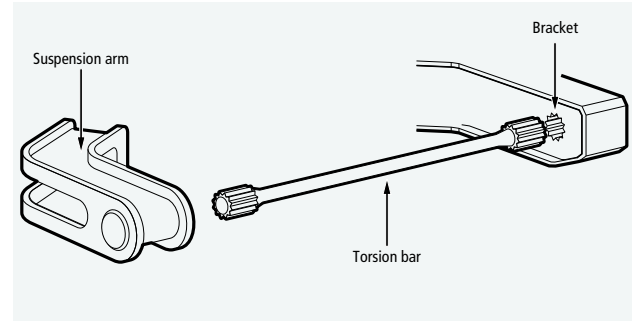
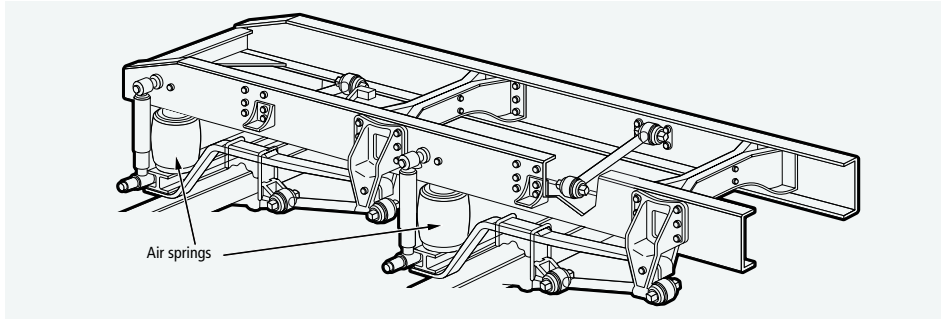

FIGURE 49 | Torsion bar



PNEUMATIC SUSPENSION

FIGURE 50 | Pneumatic suspension



RUBBER PAD SUSPENSION

FIGURE 51 | Rubber pad suspension

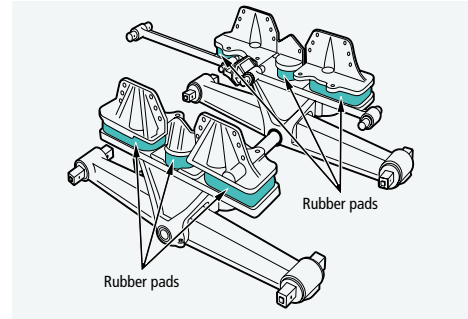

Parts Covered and How to Inspect Them

U-Bolts mounting the axle to the road vehicle or components for positioning the axle or wheel to the vehicle (e.g. torque rod and suspension brackets).

Approaching the vehicle and around the vehicle

- Check the parallelism of the wheels and pay special attention to any signs of movement of the axle or wheels from their normal position.
- Inspect the U-bolts.



Some pickup trucks or vans are equipped with suspension tables or arms that are included in the components for positioning the wheel.

Minor Defects

This section is currently blank.

Major Defects

- 14.C** A U-bolt is missing, improperly mounted, cracked or broken.
- 14.G** The wheels are not parallel.
- 14.G** One of the axles or wheels has moved from its normal position.



Parts Covered and How to Inspect Them

Leaf springs, coil springs and torsion bars

Around the vehicle

- Check for the presence, the condition and the position of the leaf springs, coil springs as well as the condition of the torsion bars.



Minor Defects

- 14.1** A leaf spring other than a master leaf or a coil is broken.



Major Defects

- 14.A** A master leaf is missing or broken (Figure 52).
- 14.A** 25% or more of the leaf springs of an assembly are broken or missing.
- 14.D** A composite leaf spring (e.g. fibreglass) is cracked along 75% of its length or has intersecting cracks.*
- * "Intersecting cracks" means two cracks that cross each other at a perpendicular angle.
- 14.E** A leaf spring or coil spring is out of place and comes into contact with a moving part.
- 14.F** A coil spring is broken to the point where the vehicle sags completely where this spring is located.



✓ Parts Covered and How to Inspect Them

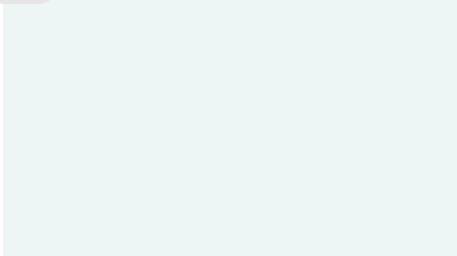

⚠ Minor Defects

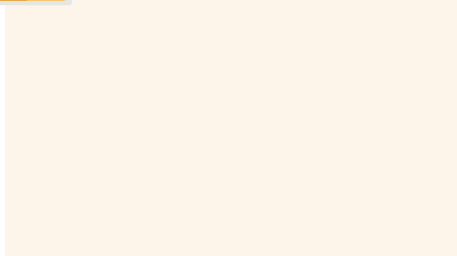

🚫 Major Defects

14.F A torsion bar is broken.



A partly or completely sagging vehicle is probably the only sign the driver can observe to indicate a broken axle, coil spring or torsion bar. It is important for the driver to pay special attention to the general stance of the vehicle.

FIGURE 52 | Master leaves

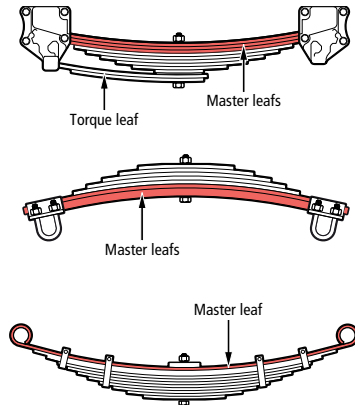

FIGURE 53 | Composite leaf spring



Parts Covered and How to Inspect Them

Rubber pads

Around the vehicle

- Check for the presence and condition of the rubber pads.

Pneumatic suspension circuit and air springs

Around the vehicle

- Check the condition of the air springs and the vehicle's balance.
- Listen for air leaks from the suspension.

Make sure the suspension is supplied with air and that the air springs are properly inflated. Generally speaking, the suspension is supplied with air when the pressure in the circuit reaches 483 kPa (70 psi).

Minor Defects

14.2 The pneumatic suspension system shows an air leak.

14.2 An air spring is damaged to the point that the cord is exposed.

14.2 An air spring shows indications of a repair.

Major Defects







14.A A rubber pad is missing or broken.

14.B An air leak in the suspension system cannot be compensated by the compressor when the engine is idling.

14.B An air spring is missing or deflated.

15 | Fuel System

This section only covers the vehicle's fuel system. The tanks used to fuel equipment such as refrigerators or generators are not covered. Urea used to operate the pollution control system is not considered a fuel.

Parts Covered	Minor Defects 	Major Defects 	Vehicles Covered		
			List 1 	List 2  	List 3 
Road vehicle's fuel tank fasteners and gasoline or diesel fuel tank filler cap		15.A 15.B	X	X	X
Leaks from the road vehicle's fuel tank		15.C	X	X	X



Parts Covered and How to Inspect Them

Road vehicle's fuel tank fasteners and gasoline or diesel fuel tank filler cap

Outside the vehicle, for all types of fuel tanks

- Inspect the fuel tank fasteners.

Outside the vehicle, for gasoline and diesel fuel tanks

- Make sure every fuel tank has a filler cap.

Leaks from the road vehicle's fuel tank

Outside the vehicle

- Inspect the tank and the visible parts of the fuel system to detect any potential leaks.

Note: Such leaks can be detected by the presence of fuel on the ground.



Minor Defects







Major Defects

- 15.A** The fuel tank is not securely fixed and there is a risk of separation.
- 15.B** The gasoline or diesel fuel tank does not have a filler cap.
- 15.C** A fuel tank shows a leak other than oozing.
- 15.C** There is a fuel leak other than sweating along the fuel supply system.





16 | Exhaust System

Parts Covered	Minor Defects 	Major Defects 	Vehicles Covered		
			List 1 	List 2 	List 3 
Exhaust system components	16.1	16.A	X	X	X



Parts Covered and How to Inspect Them

Exhaust system components

Outside the vehicle

- Inspect the visible components of the exhaust system to detect any leaks caused by defective joints, cracks or holes other than those originally provided by the manufacturer. Any trace of soot not normally found on the exhaust system is a sign of an exhaust gas leak.

Inside the vehicle

- With the engine running, if you detect the odour of exhaust gases, check whether there is a hole in the floorboard.



Minor Defects

- 16.1** Leakage of exhaust gases other than from the holes originally provided by the manufacturer of the exhaust system.



Major Defects

- 16.A** Leakage of exhaust gases enters the passenger compartment when the floorboard is perforated.



17 | Electric Brake System







Parts Covered	Minor Defects 	Major Defects 	Vehicles Covered		
			List 1 	List 2  	List 3 
Electric brake system cables and connections	17.1		X	X	
Trailer service brake		17.A	X	X	

FIGURE 54 | Electric brake system

FIGURE 55 (insert) | Electric brake intensity control



A trailer or semi-trailer operated on a public road must be equipped with a chain or cable that is sufficiently solid and aligned to make sure the trailer or semi-trailer and the tractor vehicle remain connected in the event of a breach of the coupling device. A chain or cable is not required if the trailer or semi-trailer is equipped with an independent brake system that is automatically engaged in the event of separation between the trailer or semi-trailer and the tractor vehicle.



Parts Covered and How to Inspect Them

Electric brake system cables and connections

Around the trailer

- Inspect the visible parts of the electric brake system cables and connections (at the connection and attachment points).



Check underneath the trailer to detect whether a cable is loose.

Trailer service brake

In the driver's compartment

- Start the vehicle and drive slightly forward.
- Press the brake pedal.
- Check whether the vehicle combination stops quickly.



Minor Defects

- 17.1** An electric cable or connector is improperly fixed at a connection or attachment point.



An attachment point is a point at which an electric cable is fastened to the vehicle structure (e.g. it prevents the cable from being slack).

A connection point connects a cable to its power supply. It is used, among other things, to operate the brake system.



Major Defects

- 17.A** There is a significant reduction in the braking capacity.



A reduction in the braking capacity may be caused by improper braking distribution.

18 | Hydraulic Brake System







Parts Covered	Minor Defects 	Major Defects 	Vehicles Covered		
			List 1 	List 2  	List 3 
Master cylinder reservoir	18.1	18.A	X	X	
Vacuum brake booster		18.C	X	X	
Hydraulic power brake (electric pump)		18.C	X	X	
Service brake warning light	18.3		X	X	
Braking equipment	18.2	18.B	X	X	
Service brake		18.D	X	X	
Parking brake warning light	18.4		X	X	
Parking brake	18.5		X	X	

FIGURE 56 | Master cylinder reservoir of a truck



FIGURE 57 | Master cylinder reservoir of a school bus



✓ Parts Covered and How to Inspect Them

Master cylinder reservoir

In the engine compartment

- Check the fluid level in the master cylinder using the indicator on the reservoir. If there is no indicator, open the reservoir to check the fluid level (figures 58 and 59).



If you have to open the master cylinder reservoir because you cannot check the fluid level from the exterior, take certain precautions to avoid introducing any contaminants into the fluid.

⚠ Minor Defects

18.1 The master cylinder fluid level is **lower than the minimum level** prescribed by the manufacturer or, if there is no indicator, is at more than 12.5 mm (1/2 in) below the edge of the filler opening.



If a reservoir has two caps, both compartments must be checked.



Where each vehicle in a combination of vehicles is equipped with hydraulic brakes, the reservoir of each vehicle must be checked.

🚫 Major Defects

18.A The master cylinder fluid level is less than one-quarter of the maximum level prescribed by the manufacturer.

FIGURE 58 | Master cylinder reservoir **with** indicators from the manufacturer

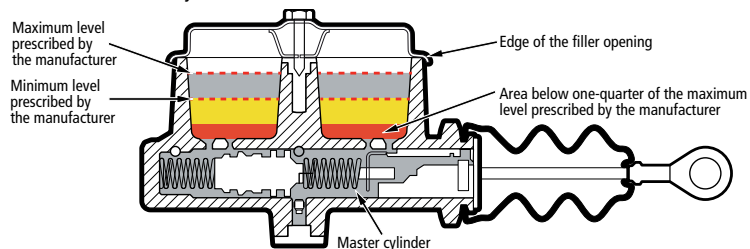
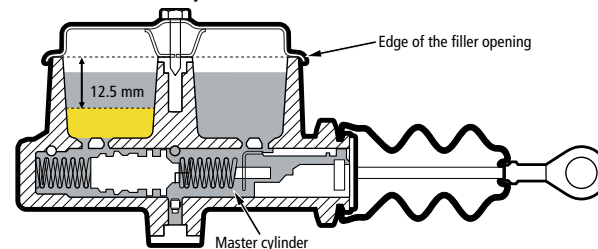

FIGURE 59 | Master cylinder reservoir **without** indicators from the manufacturer





Parts Covered and How to Inspect Them

Power brake

a) In the driver's compartment, in the case of a vacuum brake booster

- Let the engine run for a few seconds.
- Stop the engine.
- Pump the brake pedal several times.
- Apply medium brake pressure during the final brake pedal pump.
- Restart the engine while maintaining pressure on the pedal.
- Check the movement of the brake pedal.

b) In the driver's compartment, in the case of a hydraulic power brake (electric pump)

- Turn off the engine (if it is running).
- Apply medium pressure to the brake pedal.
- Listen to hear if the electric pump is working.



Most school buses are equipped with a hydraulic power brake system (electric pump), as are some straight-body trucks.



Minor Defects



Major Defects

18.C The brake pedal does not go down slightly after restarting the engine.

18.C The electric pump does not work when the engine is not running.

✓ Parts Covered and How to Inspect Them

Service brake warning light

In the driver's compartment

- Release the parking brake.
- Turn the ignition key to the "ON" or "START" position.
- Check the warning light.
- Start the engine.
- Check whether the warning light switches off.



Releasing the parking brake is required when the service brake warning light is also the parking brake warning light (see Figures 60 and 61).

! Minor Defects

18.3 The warning light does not switch on when the ignition key is in the "ON" or "START" position.

18.3 The warning light stays on when the engine is running.

🚫 Major Defects

FIGURE 60 | Parking brake warning light



FIGURE 61 | Service brake warning light





Parts Covered and How to Inspect Them

Braking equipment (leaks and pressure)

In the driver's compartment

- With the engine running, press down hard (more than for a normal braking manoeuvre) on the brake pedal for at least 10 seconds.
- Check the movement of the pedal.



When the vehicle is equipped with a hydraulic power brake, this check can be performed without the engine running.



Minor Defects

- 18.2** The pedal reaches the floor in 10 seconds or more.



Major Defects

- 18.B** The brake pedal reaches the floor in less than 10 seconds.
- 18.B** The brake pedal has to be pumped several times to pressurize the circuit, which can be felt by resistance in the pedal.



Parts Covered and How to Inspect Them

Service brake

In the driver's compartment

- Start the engine and drive forward slightly.
- Press on the brake pedal.
- Check whether the vehicle stops quickly.

Parking brake warning light

In the driver's compartment

- Turn the ignition key to the "ON" or "START" position.
- Apply the parking brake.
- Check whether the parking brake warning light is on (see Figure 60, page 117).
- Release the parking brake.
- Check whether the warning light switches off.



Minor Defects

- 18.4** The warning light does not switch on when the parking brake is activated.
- 18.4** The warning light does not switch off when the parking brake is released.



Major Defects

- 18.D** There is a significant reduction in the braking capacity.





Parts Covered and How to Inspect Them

Parking brake

In the driver's compartment, while the engine is running

- Apply the parking brake.
- Try to delicately drive the vehicle forward.⁷
- Release the parking brake.
- Slowly drive a few metres forward, watching the wheel rotation in the rearview mirrors.



Minor Defects

- 18.5** The parking brake does not prevent the vehicle from moving when the driver tries to drive forward.
- 18.5** The parking brake does not let the wheels turn freely when released.



With a combination of vehicles, you may be required to turn slightly to one side and the other to get a good view of all the wheels.



The parking brake cannot be checked on certain heavy vehicles equipped with an automatic transmission because the transmission cannot be shifted into gear while the parking brake is engaged. In that case, it does not have to be checked.



Major Defects

7. For an automatic transmission, the gearshift lever must be in the "DRIVE" position. For a manual transmission, be extra careful and select the highest gear that allows the vehicle to move forward (e.g. third gear).

19 | Pneumatic Brake System







Parts Covered	Minor Defects 	Major Defects 	Vehicles Covered		
			List 1 	List 2  	List 3 
Low air pressure warning device (visual, light or buzzer)	19.1 19.2	19.A	X	X	X
Compressor (performance)		19.B	X	X	X
Pressure regulator (starting and stopping of the compressor)	19.3		X	X	X
Braking equipment (leaks)	19.4	19.C	X	X	X
Service brake		19.D	X	X	X
Parking brake	19.5		X	X	X

FIGURE 62 | Compressed air pressure gauge



The compressed air pressure gauges indicate the air pressure in the service tanks of the bus, truck or tractor. Because the service brake system has two independent circuits, there are two gauges on the dashboard, that is, one for each circuit: the primary and secondary circuits. Some vehicles are equipped with a single gauge with two needles, one for each circuit.

FIGURE 63 | Compressed air pressure gauge with two needles



FIGURE 64 | Trailer air supply control



FIGURE 65 | Parking brake air supply control



With a pneumatic brake system, it is necessary to make sure that the main air flow circuits are working, including the suspension, to carry out more complete inspections.



Parts Covered and How to Inspect Them

Low air pressure warning device (visual, light or buzzer)

In the driver's compartment

- Turn the ignition key to the "ON" or "START" position.

If the low pressure warning device(s) are not in operation

- Check the pressure gauge(s).
- Release the parking brake.⁸
- Pump the brake pedal while watching the pressure gauge to check the pressure at which the low pressure warning device(s) activate (Figures 66 and 67, page 124).

If the low pressure warning device(s) are in operation

- Check the pressure gauges.
- Start the engine to increase the air pressure.
- Continue to check the pressure gauges to make sure the warning device(s) are working until the pressure in the system reaches at least 380 kPa (55 psi).



Minor Defects

Only for vehicles equipped with more than one warning device

- 19.1** The vehicle's low pressure warning buzzer does not work when the air pressure in the system is below 380 kPa (55 psi).
- 19.2** The vehicle's low pressure warning light and visual device do not work when the air pressure in the system is below 380 kPa (55 psi).



Major Defects

- 19.A** None of the low pressure warning devices (visual, light and buzzer) work when the air pressure in the system is below 380 kPa (55 psi).

8. It is preferable to release the parking brake if the vehicle is not equipped with an anti-compounding brake device to avoid damaging the brake chambers.

FIGURE 66 | Warning light



FIGURE 67 | Visual warning device (wig wag)



FIGURE 68 | Pressure gauge indicating a pressure of 620 kPa (90 psi)





Parts Covered and How to Inspect Them

Compressor (performance)

In the driver's compartment

- Release the parking brake.
- While the engine is idling, make sure the compressor is working by watching whether the needles in the gauge(s) is or are rising.
- Press on the brake pedal.
- Watch the pressure gauge(s) while keeping the brake pedal down to check whether the compressor can reach and maintain air pressure at the prescribed threshold of 620 kPa (90 psi).



Make sure air pressure is maintained at a minimum of 620 kPa (90 psi) while the engine is idling, that the service brake is fully engaged and that the parking brake is released.



Minor Defects



Major Defects

- 19.B** The air compressor cannot reach or maintain air pressure of at least 620 kPa (90 psi).





Parts Covered and How to Inspect Them

Pressure regulator (starting and stopping of the compressor)

a) Stopping of the compressor

In the driver's compartment

- While watching the pressure gauges, run the engine* until the air pressure stops rising.
- Watch the pressure gauge(s) to check the pressure at which the compressor stops; at this point, the gauge needles stop rising (Figure 69).

* Running the engine at around 1,000 RPM reduces the time required to carry out this check.



Minor Defects

19.3 The compressor does not switch off when the air pressure is between 805 kPa (117 psi) and 945 kPa (137 psi).



The purging noise of the dehumidifier is a sign that the compressor is switching off.



Major Defects

FIGURE 69 | Compressor stopping range



If your vehicle is equipped with drum brakes with self-adjusting brake levers, a simple procedure allows you to make sure that the play compensation or the space between the brake linings and the drum is optimal. To follow this procedure, when the brakes are cold, you must:

1. Release the parking brakes.
2. Bring the system up to maximum air pressure (120 psi).
3. Fully depress the brake pedal for five seconds and then release it completely.
4. Carry out this procedure four or five times in a row to ensure the play compensation is complete.



Parts Covered and How to Inspect Them

b) Starting of the compressor

In the driver's compartment

- Release the parking brake.⁹
- With the engine running, watch the pressure gauge(s).
- Pump the brake pedal while watching the pressure gauges to check the pressure at which the compressor starts (see Figure 70).



Minor Defects

- 19.3** The compressor starts when the pressure is less than or equal to 550 kPa (80 psi).



Major Defects

FIGURE 70 | Pressure gauge indicating a pressure of 550 kPa (80 psi)



9. It is preferable to release the parking brake if the vehicle is not equipped with an anti-compounding brake device to avoid damaging the brake chambers.



Parts Covered and How to Inspect Them

Braking equipment (leaks)

In the driver's compartment

- Release the parking brake.
- Run the engine* until the air pressure rises to the maximum level in the system.
- Turn off the engine.
- Press the brake pedal all the way down.
- Watch the pressure gauge while keeping the brake pedal fully depressed and listen carefully for an air leak.
- If there is a continuous drop in air pressure, hold the brake pedal fully depressed for at least one minute and evaluate whether the defect is major or minor.



Important! The parking brake must always be disengaged to carry out this check.

* Running the engine at around 1,000 RMP reduces the time required to carry out this check.



Minor Defects

19.4 Audible air leak.



Some audible air leaks can be detected during the inspection outside the vehicle. The driver must be on the lookout for them throughout the inspection.

19.4 Single-unit vehicle: the loss of air pressure in one minute **exceeds 20 kPa (3 psi).**

19.4 Two-unit vehicle: the loss of air pressure in one minute **exceeds 28 kPa (4 psi).**

19.4 Three-unit vehicle: the loss of air pressure in one minute **exceeds 35 kPa (5 psi).**



Major Defects

19.C Single-unit vehicle: the loss of air pressure in one minute **exceeds 40 kPa (6 psi).**

19.C Two-unit vehicle: the loss of air pressure in one minute **exceeds 48 kPa (7 psi).**

19.C Three-unit vehicle: the loss of air pressure in one minute **exceeds 62 kPa (9 psi).**



Parts Covered and How to Inspect Them

Service brake

In the driver's compartment

- Start the engine and drive forward slightly.
- Press on the brake pedal.
- Check whether the vehicle stops quickly.

Parking brake

In the driver's compartment, with the engine running

- Apply the parking brake.*
- Try to delicately drive the vehicle forward.¹⁰
- Release the parking brake.
- Drive slightly forward while watching the wheel rotation in the rearview mirrors.**

* For a combination of vehicles, a second check must be carried out for the trailer's parking brake.

** With a combination of vehicles, you may have to turn the steering wheel slightly from one side to the other to get a better view of all the wheels.



Minor Defects

19.5 The parking brake does not prevent the vehicle from moving when the driver tries to drive forward.

19.5 The parking brake does not let the wheels turn freely when released.



The parking brake cannot be checked on certain heavy vehicles equipped with an automatic transmission because the transmission cannot be shifted into gear while the parking brake is engaged. In that case, it does not have to be checked.



Major Defects

19.D There is a significant reduction in the braking capacity.

10. For an automatic transmission, the gearshift lever must be in the "DRIVE" position. For a manual transmission, be extra careful and select the highest gear that allows the vehicle to move forward (e.g. third gear).

20 | Passenger Transport

These inspections apply to buses and minibuses configured to transport passengers. The parts to be checked are in addition to the parts to be checked listed in the previous sections.





Parts Covered	Minor Defects 	Major Defects 	Vehicles Covered		
			List 1 	List 2 	List 3 
Stanchions, horizontal bars, grab handles, guard panels and shock-absorbing material on stanchions (if provided by the manufacturer)	20.1 20.2			X	X
Floor and steps in the passenger compartment	20.3			X	X
Central aisle and passenger entrance lighting systems	20.4			X	X
Overhead (top) luggage racks or compartments inside the passenger compartment	20.5			X	X
Passenger seats and benches	20.6			X	X
Retractable stop sign	20.7			X	
Alternately flashing lights (on the stop sign)	20.7			X	
Flashing red lights	20.8			X	
Alternately flashing yellow lights	20.8			X	

FIGURE 71 | School bus



Parts Covered and How to Inspect Them

Stanchions, horizontal bars, grab handles, guard panels and shock-absorbing material on stanchions (if provided by the manufacturer)

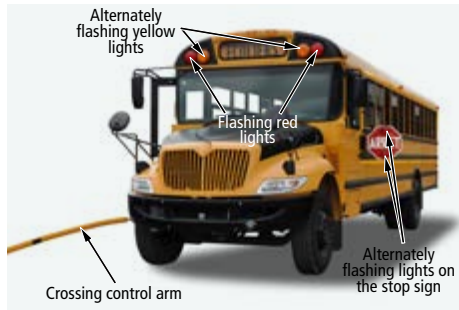
Inside the vehicle

- Check the stanchions, horizontal bars, grab handles, guard panels and, if provided by the manufacturer, the shock-absorbing material on the stanchions (see Figure 72, page 132).



Minor Defects

- 20.1** A stanchion, a horizontal bar, a grab handle or a guard panel is not securely mounted.
- 20.2** Shock-absorbing material on stanchions provided by the manufacturer is missing or inadequate.*

* Inadequate means worn or broken to the point of no longer providing protection.



Major Defects

FIGURE 72 | Stanchions, horizontal bars, grab handles and guard panel

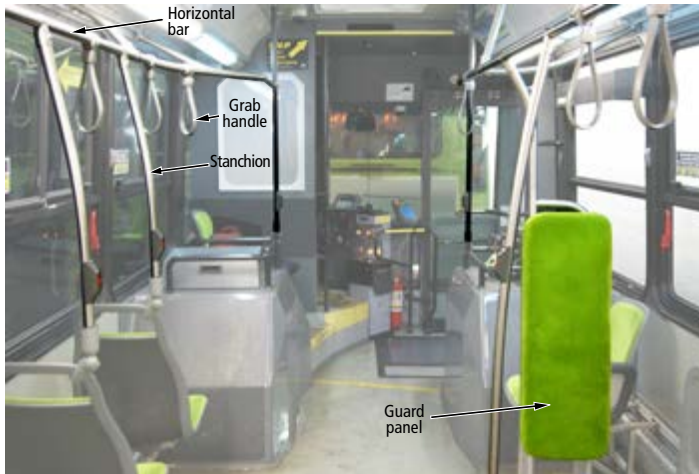



Parts Covered and How to Inspect Them

Floor and steps in the passenger compartment

Outside the vehicle

- Inspect the steps before entering the vehicle.

Inside the vehicle

- Inspect the visible surface of the floor, more specifically the central aisle and areas between the seats.

Central aisle and passenger entrance lighting systems

Inside the vehicle

- Activate the lighting system switch for the central aisle, steps and boarding space.
- Check whether the central aisle, steps and boarding space can be illuminated.



Minor Defects

20.3 The floor or a step in the passenger compartment is cracked, worked (misshapen) or perforated.*

* There is a defect when the condition of the floor poses a danger for the occupants.



Perforations performed by the manufacturer are not considered defects (e.g. holes in the floor because benches have been removed).

20.4 The central aisle, entrance or exit steps or boarding space cannot be illuminated.



Major Defects



✓ Parts Covered and How to Inspect Them

Overhead (top) luggage racks or compartments inside the passenger compartment

Inside the vehicle

- Inspect the overhead luggage racks or compartments (see Figures 73 and 74).
- Make sure they are securely mounted and can retain luggage safely.

⚠ Minor Defects

20.5 A top luggage rack or compartment is not securely mounted or cannot retain luggage.



Although the circle check only requires a sight and sound inspection, we suggest you apply light pressure on the luggage racks or compartments during this inspection to help you detect any defects in their mountings.

🚫 Major Defects

FIGURE 73 | Overhead luggage compartment

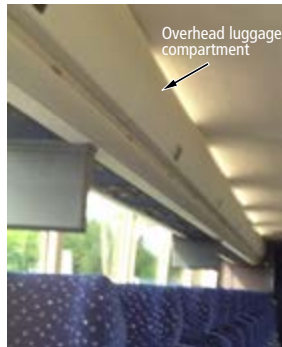

FIGURE 74 | Overhead luggage rack





Parts Covered and How to Inspect Them

Passenger seats and benches¹¹

Inside the vehicle, while walking up and down the central aisle

- Inspect the position and general condition of the seats and benches.



Minor Defects

20.6 A seat or bench is inadequate.*

* A seat or bench is inadequate if it is not in good working order to the point of being unsafe.



One-man seats (folding seats) must also be checked.



Major Defects

11. Inspections of the driver's seat are presented in Section 13.



THIS SECTION ONLY APPLIES TO SCHOOL BUSES

Parts Covered and How to Inspect Them

Retractable stop sign

In the driver's compartment

- Activate the retractable stop sign.

Outside the vehicle

- Check the position of the stop sign.

Minor Defects

- 20.7** The stop sign does not move into a position that is perpendicular to the bus.



Although a minor defect does not prohibit a vehicle from being operated, the *Highway Safety Code* requires drivers to turn on the compulsory stop sign to take on or discharge school children or persons under age 18. If the stop sign mechanism is defective and cannot be deployed, the driver may not take on or discharge school children or persons under age 18.¹²

Major Defects

12. This is an offence under section 456 of the *Highway Safety Code*. The driver of the vehicle is subject to a fine of \$600 to \$2,000.

THIS SECTION ONLY APPLIES TO SCHOOL BUSES



Parts Covered and How to Inspect Them

Alternately flashing lights (on the stop sign)

In the driver's compartment

- Activate the retractable stop sign.

Outside the vehicle

- Check the alternately flashing lights on the retractable stop sign.

Flashing red lights

From the driver's compartment

- Switch on the flashing red lights.

Outside the vehicle

- Check the front and rear flashing red lights.



Minor Defects

20.7 One or more alternately flashing lights do not switch on when the stop sign is perpendicular to the vehicle.

20.8 One or more front and rear flashing red lights do not work when switched on.



Although a minor defect does not prohibit a vehicle from being operated, the *Highway Safety Code* requires drivers to activate the flashing red lights to take on or discharge school children or persons under age 18. If both rear flashing lights or both front flashing lights do not work when switched on, the driver may not let on or discharge school children or persons under age 18.¹³



Major Defects

13. This is an offence under section 456 of the *Highway Safety Code*. The driver of the vehicle is subject to a fine of \$600 to \$2,000.

THIS SECTION ONLY APPLIES TO SCHOOL BUSES



Parts Covered and How to Inspect Them

Alternately flashing yellow lights

From inside the vehicle

- Activate the switch and check the alternately flashing yellow lights through the convex mirrors.

Important! Do not attempt to perform the check by performing any manoeuvres that may be unsafe.



Minor Defects

- 20.8** One or more alternately flashing yellow lights do not work when switched on.



Major Defects



Occupational Injury Prevention

This section presents the risks of occupational injuries to which individuals who carry out the circle check are exposed and the various ways in which they can be prevented.

In more than 80% of cases, occupational injuries to heavy vehicle drivers occur while they are away from the wheel of their vehicle. These accidents occur when drivers climb down from the cab or as they carry out various duties such as handling or transferring cargo, performing a circle check, tarping or securing the load.

It should be noted that drivers who have good reasons to believe their vehicle has defects that are likely to jeopardize their health and safety can refuse to drive the vehicle, even if they are pressured into doing so.

■ Refusing to perform work

Businesses under provincial jurisdiction

Under section 12 of the *Act respecting occupational health and safety*, a driver employed by a business under provincial jurisdiction may refuse to drive a vehicle he or she considers hazardous to his or her health or safety:

“A worker has a right to refuse to perform particular work if he has reasonable grounds to believe that the performance of that work would expose him to danger to his health, safety or physical well-being, or would expose another person to a similar danger.”

Businesses under federal jurisdiction

Under section 128 of the *Canadian Labour Code*, Part II, a driver employed by a business under federal jurisdiction can refuse to drive a vehicle he or she considers hazardous to his or her health or safety:

“Subject to this section, an employee may refuse to use or operate a machine or thing, to work in a place or to perform an activity, if the employee while at work has reasonable cause to believe that

- the use or operation of the machine or thing constitutes a danger to the employee or to another employee;
 - a condition exists in the place that constitutes a danger to the employee;
 - the performance of the activity constitutes a danger to the employee or to another employee.
- [...]”

For more information

Businesses under provincial jurisdiction

Contact the Commission des normes, de l'équité, de la santé et de la sécurité du travail
1 866 302-2778
www.csst.qc.ca

Businesses under federal jurisdiction

Contact Employment and Social Development Canada – Labour Program
1 800 641-4049
www.edsc.gc.ca

■ Risks and how to prevent them

Inspections under the hood

Risks

- Slipping caused by mud or ice in the bumper footholds;
- Falling while raising the hood;
- Sustaining a back injury (while handling the hood, slipping or falling);
- Sustaining an injury from a dropping hood or cab;
- Sustaining burns while touching a hot component in the engine compartment;
- Sustaining a musculoskeletal injury as a result of overexertion while raising the hood.

Prevention

When you unlatch the hood, lift each corner to make sure it is not stuck. This will spare you the excessive effort required to open a stuck hood.

Engine compartment under the hood

- Before opening the hood, make sure the footholds (openings in the bumpers in most cases) are free of any material that could cause your foot to slip.



- Before opening the hood, test its resistance to opening as it could stick as a result of ice or heat.



- Once the hood is open, make sure it will stay in that position.
- If possible, avoid climbing onto the tire to carry out the inspection. Instead, find support on a flat surface.
- While the engine is running, only carry out a visual inspection. Never place your hand between engine components to avoid sustaining burns from a hot component or getting your hand stuck in a belt.

Engine compartment under a tilt cab¹⁴

- Stay far enough back that you will not be hit by the cab when tilting it open or shut.
- Block the cab if there is no safety mechanism to prevent it from falling as a result of a pressure burst.



14. Tilt the cab only if the inspection cannot be carried out using the panels provided for that purpose.

Engine compartment with doors

- Make sure the engine compartment doors are completely open and locked in place.



Getting in and out of the vehicle

Risks

- Falling and slipping that could cause back injuries, sprains or contusions while climbing in or out of the cab.

Prevention

- As a point of support, choose a fixed object, such as the grab handles, and avoid using the steering wheel.
- Make sure the running boards are free of any slippery material (mud, ice, etc.).



- Install non-skid running boards that are wide enough to provide adequate foot support (wider than 18 cm).

- Apply the three-point support principle when getting in or out of the cab.



- Step down from the cab backward rather than jumping out.
- Avoid placing obstacles in the footrests (e.g. a shoe brush).

Inspecting the vehicle's exterior

Risks

- Being struck by a moving vehicle;
- Falling while walking on a slippery or uneven surface.

Prevention

- Choose a location that is:
 - level and free of snow or ice;
 - well lit in order to see any uneven areas in the ground;
 - sheltered from wind and traffic.
- Apply the parking brake.



- Wear appropriate shoes or boots.
- If possible, wear reflective clothing when you stop your vehicle on the side of the road.
- Use a flashlight as needed to increase visibility in the dark.

Hitching and unhitching the semi-trailer

Risks

- Sliding, falling or striking a fixed object while unlocking the fifth wheel;
- Sliding and falling while;
 - climbing onto or down from platform providing access to the coupling device,
 - plugging in the lighting cable and the connection lines;
- Sustaining an injury from overexertion while turning the crank to raise the landing gear.

Prevention

- Use a hook that is long and curved enough to avoid having to stretch or lose your balance while unlocking the fifth wheel.



- Install metal grating that extends to the base of the fifth wheel when the lines cannot be connected from the ground. This will provide you with a flat, non-skid surface to stand on.



- Consider installing handrails or handles that will make it easier to use the “three-point support” technique.
- Position yourself parallel to the semi-trailer, extending the leg closest to the trailer slightly behind you for better support. Place the crank in a position that will require the least amount of effort to operate.



Appendices

144



Appendix 1

Sample Circle Check Report

Appendix 2

Lists of Defects

List 1 – Heavy Vehicles

List 2 – Buses

List 3 – Motor Coaches

Appendix 3

Pressure Conversion Table

Appendix 4

Measurement Conversion Table
(length)

Appendix 5

Offences

Appendix 1 – Sample Circle Check Report

CIRCLE CHECK REPORT

Operator

Name: _____

Vehicle

Licence plate number:* _____

Kilometrage: _____

Circle Check

Date: _____

Time: _____

Municipality or location: _____

* or the unit number, if it appears on the registration certificate

Defects

No defects were noted during the circle check

Person Who Performed the Inspection

Last name: _____ (please print) First name: _____ (please print)

Person designated by the operator to perform the circle check: Yes No

I personally inspected the vehicle and confirm that it was inspected according to the applicable requirements.

Signature: _____

Driver's Declaration (where the driver did not perform the circle check)

Buses, Minibuses, Tow Trucks or Emergency Vehicles
The driver can decide to review the existing report that was completed by the person designated by the operator, or by the previous driver, and co-sign below.

or

All Other Vehicles
The driver can decide to review the existing report that was completed by the person designated by the operator and co-sign below.

The driver can always decide to perform a complete inspection of the vehicle himself/herself and fill out a new circle check report.

I have reviewed the circle check report.

Driver's signature: _____

Driver's signature: _____



■ Appendix 2 – Lists of Defects

List 1 – Heavy vehicle

This list applies to heavy vehicles other than a bus, minibus or motor coach. Any trailer towed by a bus, minibus or motor coach must be inspected in accordance with list 2.

Minor defects	Major defects
1. Coupling devices	
The defects provided for in points 1.B to 1.F apply when the vehicles are coupled.	
1.1 Fastener component(s) of the coupling device missing, broken or loose	1.A Coupling plate or kingpin bent to an extent that it makes coupling difficult, cracked or not securely fixed
1.2 Safety fasteners and coupling components missing, damaged or insecurely mounted	1.B Movement between the fifth wheel and the frame
	1.C More than 20% of the fasteners of the coupling mechanism damaged or missing
	1.D 25% or more of the locking pins are missing or not working
	1.E Coupling mechanism not properly closed or locked
	1.F Coupling mechanism component missing, insecurely fixed, not properly adjusted or so damaged that it might rupture or fall off
2. Frame and cargo body	
2.1 Side rails cracked or cross members cracked or broken	2.A Side rails might break
2.2 Fixed components of the body missing or insecurely mounted	2.B Side rails or cross members sagged in a way that makes a mobile part and the body touch
	2.C More than 25% of the locking pins of the sliding bogie missing or not engaged

Minor defects	Major defects
3. Heater and defroster	
3.1 Windshield blower not operating	
4. Driver controls	
4.1 Accelerator or clutch not operating properly	4.A Engine fails to return to idle when accelerator is released
4.2 Horn not operating properly	
5. Steering	
5.1 Misplacement of the steering column in relation to the normal position or adjustable steering wheel not remaining in set position	5.A Misplacement of the steering column or wheel in relation to the normal position showing a risk of separation
5.2 Fluid level of power steering not the one prescribed by the manufacturer	5.B Power steering inoperative
5.3 Pump belt cut	
6. Windshield wiper and washer	
6.1 Wiper on passenger's side missing or inadequate	6.A Wiper on driver's side missing or inadequate
6.2 Windshield washer system ineffective	
7. Emergency material	
7.1 First-aid kit required by law insecurely fixed and not readily accessible	
7.2 Chemical extinguisher required by law insecurely fixed, inadequate and not readily accessible	
8. Headlights and lights	
8.1 Low beam, parking light, turn-indicator light, brake light or license plate light that does not turn on	8.A Failure of all low-beams
	8.B At the rear of a single-unit vehicle or the last vehicle of a combination of vehicles: <ul style="list-style-type: none"> • None of the right turn-signal lights work • None of the left turn-signal lights work • None of the brake lights work • None of the parking lights work



Minor defects	Major defects
9. Tires	
9.1 Wear indicator for a tire touches the roadway or depth of a groove is equal to or less than the wear indicator	9.A For a tire mounted on the steering axle of a motor vehicle having a GVWR of 4,500 kg or more, the depth of 2 adjacent grooves is equal to or less than the wear indicator
9.2 A tire in the same wheel assembly having foreign material embedded in the tread or sidewall that could cause a puncture	9.B Single tire or the dual tires of the same wheel assembly having foreign material embedded in the tread or sidewall that could cause a puncture
9.3 A tire in the same wheel assembly so damaged that the cord or steel belt is exposed	9.C Single tire or the dual tires of the same wheel assembly so damaged that the cord or steel belt is exposed
9.4 Distorted tire, tread or sidewall separated from the carcass of the tire	9.D Tire in contact with a fixed part of the vehicle, a flat tire or a tire losing air or a bulge
9.5 Valve worn down, damaged, scraped or gashed	
10. Doors and other openings	
10.1 Driver's door opens with difficulty or fails to open	10.A Passenger compartment door fails to close securely
11. Glass and mirrors	
11.1 Windshield or side window on each side of the driver's compartment fails to provide the required view to the driver as a result of being damaged	
11.2 Outside rearview mirrors required by the Code missing, damaged or may not be adjusted and remain in set position	
11.3 Outside rearview mirror insecure or shows a sharp edge	
12. Wheels, hubs and fasteners	
12.1 Lubricant under the minimum level or lubricant leakage of wheel bearing other than oozing	12.A Wheel bearing lubricant missing or not visible through a sight glass
12.2 Support or mounting holding the spare wheel not securely fixed to hold it	12.B Wheel fastener is missing, cracked, broken or insecure
	12.C Wheel damaged or shows signs of repair with welds

Minor defects	Major defects
13. Seat	
13.1 Driver's seat inadequate or not staying in set position	13.A Driver's seat belt missing, modified or inadequate
14. Suspension	
14.1 Leaf spring other than a main spring leaf or broken coil spring	14.A Main spring leaf, rubber pad or 25% or more of the leaf springs in the assembly are broken or missing
14.2 Air leak in suspension, ball so damaged that the cord is exposed or repaired	14.B Air leak in the system not compensated by compressor or ball missing or deflated
	14.C Component for mounting the axle missing, insecure, cracked or broken
	14.D Composite spring leaf cracked over 75% of its length or has cracks
	14.E Leaf spring or coil spring moved and in contact with moving parts
	14.F Coil spring so broken that the vehicle is completely sagged or torsion bar cracked
	14.G Broken axle or component for positioning the axle or wheel missing, insecure, cracked, broken or damaged so as to affect the parallelism or cause an axle or wheel to move out of its position
15. Fuel system	
	15.A Tank poorly fixed and could break loose
	15.B Cap missing
	15.C Fuel leak other than oozing
16. Exhaust system	
16.1 Leak of exhaust gas elsewhere than where intended by the manufacturer	16.A Leak that causes exhaust gas to enter the passenger compartment where the floor is perforated
17. Electric brake system	
17.1 Cable or electric connection not securely attached to the fasteners or connection	17.A Important reduction in the braking capacity of the service brake



Minor defects	Major defects
18. Hydraulic brake system	
18.1 Fluid level in the reservoir of the master cylinder below minimum level required	18.A Fluid level in the reservoir of the master cylinder lower than one quarter of the maximum level specified by the manufacturer
18.2 Brake pedal reaches the floor	18.B Brake pedal reaches the floor within less than 10 seconds or pedal has to be depressed several times before getting pressure
18.3 Warning light on while the engine is running or not on where the ignition key is in the "on" or "start" position	18.C Brake boost or power assist is inoperative
18.4 Warning light not on when the parking brake is applied and released or not turned off when released	18.D Important reduction in the braking capacity of the service brake
18.5 Parking brake not operating properly	
19. Pneumatic brake system	
19.1 Low pressure warning buzzer not operating properly	19.A No low pressure visual or warning light or buzzer is operating properly
19.2 Low pressure visual and warning lights not operating properly	19.B Air compressor not operating properly
19.3 Pressure regulator not operating properly	19.C Air leak whose rate within one minute exceeds 40 kPa (6lb/in ²) for a single-unit vehicle, 48 kPa (7lb/in ²) for a two-unit vehicle and 62 kPa (9lb/in ²) for a three-unit vehicle
19.4 Audible air leak or whose rate within one minute exceeds 20 kPa (3lb/in ²) for a single-unit vehicle, 28 kPa (4lb/in ²) for a two-unit vehicle and 35 kPa (5lb/in ²) for a three-unit vehicle	19.D Important reduction in the braking capacity of the service brake
19.5 Parking or emergency brake not operating properly	
Specific inspections required by the operator	

List 2 – Bus

This list applies to buses (other than motor coaches), minibuses and any trailer towed by a bus, minibus or motor coach.

Minor defects	Major defects
1. Coupling devices	
The defects provided for in points 1.C and 1.F apply when vehicles are coupled.	
1.1 Fastener component(s) of the coupling device missing, broken or loose	1.C More than 20% of the fasteners of the coupling mechanism damaged or missing
1.2 Safety fasteners and coupling components missing, damaged or insecurely mounted	1.F Coupling mechanism component missing, insecurely fixed, not properly adjusted or so damaged that it might rupture or fall off
2. Frame and cargo body	
2.1 Side rails cracked or cross members cracked or broken	2.A Side rails might break
2.2 Fixed components of the body missing or insecurely mounted	2.B Side rails or cross members sagged in a way that makes a mobile part and the body touch
2.3 Outside door of a luggage or auxiliary compartment inadequate or not securely mounted on the road vehicle	
3. Heater and defroster	
3.1 Windshield blower not operating	
4. Driver controls	
4.1 Accelerator or clutch not operating properly	4.A Engine fails to return to idle when accelerator is released
4.2 Horn not operating properly	
5. Steering	
5.1 Misplacement of the steering column in relation to the normal position or adjustable steering wheel not remaining in set position	5.A Misplacement of the steering column or wheel in relation to the normal position showing a risk of separation
5.2 Fluid level of power steering not the one prescribed by the manufacturer	5.B Power steering inoperative
5.3 Pump belt cut	



Minor defects	Major defects
6. Windshield wiper and washer	
6.1 Wiper on passenger's side missing or inadequate	6.A Wiper on driver's side missing or inadequate
6.2 Windshield washer system ineffective	
7. Emergency material	
7.1 First-aid kit required by law insecurely fixed and not readily accessible	
7.2 Chemical extinguisher required by law insecurely fixed, inadequate and not readily accessible	
8. Headlights and lights	
8.1 Low beam, parking light, turn-indicator light, brake light or license plate light that does not turn on	8.A Failure of all low-beams
	8.B At the rear of a single-unit vehicle or the last vehicle of a combination of vehicles: <ul style="list-style-type: none"> • None of the right turn-signal lights work • None of the left turn-signal lights work • None of the brake lights work • None of the parking lights work
9. Tires	
9.1 Wear indicator for a tire touches the roadway or depth of a groove is equal to or less than the wear indicator	9.A For a tire mounted on the steering axle of a motor vehicle having a GVWR of 4,500 kg or more, the depth of 2 adjacent grooves is equal to or less than the wear indicator
9.2 A tire in the same wheel assembly having foreign material embedded in the tread or sidewall that could cause a puncture	9.B Single tire or the dual tires of the same wheel assembly having foreign material embedded in the tread or sidewall that could cause a puncture
9.3 A tire in the same wheel assembly so damaged that the cord or steel belt is exposed	9.C Single tire or the dual tires of the same wheel assembly so damaged that the cord or steel belt is exposed

Minor defects	Major defects
9.4 Distorted tire, tread or sidewall separated from the carcass of the tire	9.D Tire in contact with a fixed part of the vehicle, a flat tire or a tire losing air or a bulge
9.5 Valve worn down, damaged, scraped or gashed	
10. Doors and other openings	
10.1 Driver's door opens with difficulty or fails to open	10.A Passenger compartment door fails to close securely
	10.B Emergency exit blocked
	10.C Emergency door inadequate or its warning light or buzzer not in good working order
11. Glass and mirrors	
11.1 Windshield or side window on each side of the driver's compartment fails to provide the required view to the driver as a result of being damaged	
11.2 Outside rearview mirrors required by the Code missing, damaged or may not be adjusted and remain in set position	
11.3 Outside rearview mirror insecure or shows a sharp edge	
11.4 Side window of a school bus on each side of the driver's compartment and immediately behind the driver's compartment fails to provide the required view to the driver as a result of being damaged	
12. Wheels, hubs and fasteners	
12.1 Lubricant under the minimum level or lubricant leakage of wheel bearing other than oozing	12.A Wheel bearing lubricant missing or not visible through a sight glass
12.2 Support or mounting holding the spare wheel not securely fixed to hold it	12.B Wheel fastener is missing, cracked, broken or insecure
	12.C Wheel damaged or shows signs of repair with welds



Minor defects	Major defects
13. Seat	
13.1 Driver's seat inadequate or not staying in set position	13.A Driver's seatbelt missing modified or inadequate
14. Suspension	
14.1 Leaf spring other than a main spring leaf or broken coil spring	14.A Main spring leaf, rubber pad or 25% or more of the leaf springs in the assembly are broken or missing
14.2 Air leak in suspension, ball so damaged that the cord is exposed or repaired	14.B Air leak in the system not compensated by compressor or ball missing or deflated
	14.C Component for mounting the axle missing, insecure, cracked or broken
	14.D Composite spring leaf cracked over 75% of its length or has cracks
	14.E Leaf spring or coil spring moved and in contact with moving parts
	14.F Coil spring so cracked or broken that the vehicle is completely sagged or torsion bar cracked
	14.G Broken axle or component for positioning the axle or wheel missing, insecure, cracked, broken or damaged so as to affect the parallelism or cause an axle or wheel to move out of its position
15. Fuel system	
	15.A Tank poorly fixed and could break loose
	15.B Cap missing
	15.C Fuel leak other than oozing
16. Exhaust system	
16.1 Leak of exhaust gas elsewhere than where intended by the manufacturer	16.A Leak that causes exhaust gas to enter the passenger compartment where the floor is perforated

Minor defects	Major defects
17. Electric brake system	
17.1 Cable or electric connection not securely attached to the fasteners or connection	17.A Important reduction in the braking capacity of the service brake
18. Hydraulic brake system	
18.1 Fluid level in the reservoir of the master cylinder below minimum level required	18.A Fluid level in the reservoir of the master cylinder lower than one quarter of the maximum level specified by the manufacturer
18.2 Brake pedal reaches the floor	18.B Brake pedal reaches the floor within less than 10 seconds or pedal has to be depressed several times before getting pressure
18.3 Warning light on while the engine is running or not on where the ignition key is in the "on" or "start" position	18.C Brake boost or power assist is inoperative
18.4 Warning light not on when the parking brake is applied and released or not turned off when released	18.D Important reduction in the braking capacity of the service brake
18.5 Parking brake not operating properly	
19. Pneumatic brake system	
19.1 Low pressure warning buzzer not operating properly	19.A No low pressure visual or warning light or buzzer is operating properly
19.2 Low pressure visual and warning lights not operating properly	19.B Air compressor not operating properly
19.3 Pressure regulator not operating properly	19.C Air leak whose rate within one minute exceeds 40 kPa (6lb/in ²) for a single-unit vehicle, 48 kPa (7lb/in ²) for a two-unit vehicle and 62 kPa (9lb/in ²) for a three-unit vehicle
19.4 Audible air leak or whose rate within one minute exceeds 20 kPa (3lb/in ²) for a single-unit vehicle, 28 kPa (4lb/in ²) for a two-unit vehicle and 35 kPa (5lb/in ²) for a three-unit vehicle	19.D Important reduction in the braking capacity of the service brake
19.5 Parking or emergency brake not operating properly	



Minor defects	Major defects
20. Passenger transport	
20.1 Stanchion, horizontal bar, grab handle and guard panel insecure	
20.2 Shock-absorbing material provided by the manufacturer on stanchions missing or inadequate	
20.3 Floor or steps of passenger compartment damaged	
20.4 Lighting of passenger access or aisle inoperative	
20.5 Top luggage rack or top luggage compartment insecure or cannot retain luggage	
20.6 Passenger's seat or bench seat inadequate	
20.7 Stop sign not operating properly or one of the flashing lights does not turn on	
20.8 One of the flashing lights or one of the alternately flashing yellow lights does not turn on	
Specific inspections required by the operator	

List 3 – Motor Coach

This list applies to a motor coach. Any trailer towed by the motor coach must be inspected in accordance with list 2.

Minor defects	Major defects
1. Coupling devices	
The defects provided for in points 1.C and 1.F apply when vehicles are coupled.	
1.1 Fastener component(s) of the coupling device missing, broken or loose	1.C More than 20% of the fasteners of the coupling mechanism damaged or missing
1.2 Safety fasteners and coupling components missing, damaged or insecurely mounted	1.F Coupling mechanism component missing, insecurely fixed, not properly adjusted or so damaged that it might rupture or fall off
2. Frame and cargo body	
2.2 Fixed components of the body missing or insecurely mounted	
2.3 Outside door of a luggage compartment or of an auxiliary compartment inadequate or insecurely mounted on a road vehicle	
3. Heater and defroster	
3.1 Windshield blower not operating	
4. Driver controls	
4.1 Accelerator or clutch not operating properly	4.A Engine fails to return to idle when the accelerator is released
4.2 Horn not operating properly	
5. Steering	
5.1 Misplacement of the steering column in relation to the normal position or adjustable steering wheel not remaining in set position	5.A Misplacement of the steering column or wheel in relation to the normal position showing a risk of separation
5.2 Fluid level of power steering not the one prescribed by the manufacturer	5.B Power steering inoperative
5.3 Pump belt cut	



Minor defects	Major defects
6. Windshield wiper and washer	
6.1 Wiper on passenger's side missing or inadequate	6.A Wiper on driver's side missing or inadequate
6.2 Windshield washer system ineffective	
7. Emergency material	
7.1 First-aid kit required by law insecurely fixed and not readily accessible	
7.2 Chemical extinguisher required by law insecurely fixed, inadequate and not readily accessible	
8. Headlights and lights	
8.1 Low beam, parking light, turn-indicator light, brake light or license plate light that does not turn on	8.A Failure of all low-beams
	8.B At the rear of a single-unit vehicle or the last vehicle of a combination of vehicles: <ul style="list-style-type: none"> • None of the right turn-signal lights work • None of the left turn-signal lights work • None of the brake lights work • None of the parking lights work
9. Tires	
9.1 Wear indicator for a tire touches the roadway or depth of a groove is equal to or less than the wear indicator	9.A For a tire mounted on the steering axle of a motor vehicle having a GVWR of 4,500 kg or more, the depth of 2 adjacent grooves is equal to or less than the wear indicator
9.2 A tire in the same wheel assembly having foreign material embedded in the tread or sidewall that could cause a puncture	9.B Single tire or the dual tires of the same wheel assembly having foreign material embedded in the tread or sidewall that could cause a puncture
9.3 A tire in the same wheel assembly so damaged that the cord or steel belt is exposed	9.C Single tire or the dual tires of the same wheel assembly so damaged that the cord or steel belt is exposed

Minor defects	Major defects
9.4 Distorted tire, tread or sidewall separated from the carcass of the tire	9.D Tire in contact with a fixed part of the vehicle, a flat tire or a tire losing air or a bulge
9.5 Valve worn down, damaged, scraped or gashed	
10. Doors and other openings	
10.1 Driver's door opens with difficulty or fails to open	10.A Passenger compartment door fails to close securely 10.B Emergency exit blocked
11. Glass and mirrors	
11.1 Windshield or side window on each side of the driver's compartment fails to provide the required view to the driver as a result of being damaged	
11.2 Outside rearview mirror required by the Code missing, damaged or may not be adjusted and remain in set position	
11.3 Outside rearview mirror insecure or shows a sharp edge	
12. Wheels, hubs and fasteners	
12.1 Lubricant under the minimum level or lubricant leakage of wheel bearing other than oozing	12.A Wheel bearing lubricant missing or not visible through a sight glass
12.2 Support or mounting holding the spare wheel not securely fixed to hold	12.B Wheel fastener is missing, cracked, broken or insecure 12.C Wheel damaged or shows signs of repair with welds
13. Seat	
13.1 Driver's seat inadequate or not staying in set position	13.A Driver's seat belt missing, modified or inadequate
14. Suspension	
14.2 Air leak in suspension, ball so damaged that the cord is exposed or repaired	14.B Air leak in the system not compensated by compressor or ball missing or deflated



Minor defects	Major defects
	14.G Broken axle or component for positioning the axle or wheel missing, insecure, cracked, broken or damaged so as to affect the parallelism or cause an axle or wheel to move out of its position
15. Fuel system	
	15.A Tank poorly fixed and could break loose
	15.B Cap missing
	15.C Fuel leak other than oozing
16. Exhaust system	
16.1 Leak in exhaust system elsewhere than where intended by the manufacturer	16.A Leak that causes exhaust gas to enter the passenger compartment where the floor is perforated
17. Electric brake system (not subject to inspection)	
18. Hydraulic brake system (not subject to inspection)	
19. Pneumatic brake system	
19.1 Low pressure warning buzzer not operating properly	19.A No low pressure visual or warning light or buzzer is operating properly
19.2 Low pressure visual and warning lights not operating properly	19.B Air compressor not operating properly
19.3 Pressure regulator not operating properly	19.C Air leak whose rate within one minute exceeds 40 kPa (6lb/in ²) for a single-unit vehicle, 48kPa (7lb/in ²) for a two-unit vehicle and 62kPa (9lb/in ²) for a three-unit vehicle
19.4 Audible air leak or whose rate within one minute exceeds 20kPa (3lb/in ²) for a single-unit vehicle, 28kPa (4lb/in ²) for a two-unit vehicle and 35 kPa (5lb/in ²) for a three-unit vehicle	19.D Important reduction in the braking capacity of the service brake
19.5 Parking or emergency brake not operating properly	
20. Passenger transport	

Minor defects	Major defects
20.1 Stanchion, horizontal bar, grab handle and guard panel insecure	
20.2 Shock-absorbing material provided by the manufacturer on stanchions missing or inadequate	
20.3 Floor or steps of passenger compartment damaged	
20.4 Lighting of passenger access or aisle inoperative	
20.5 Top luggage rack or top luggage compartment insecure or cannot retain luggage	
20.6 Passenger's seat or bench seat inadequate	
Specific inspections required by the operator	



■ Appendix 3 – Pressure Conversion Table

psi	kPa	bar	psi	kPa	bar	psi	kPa	bar	psi	kPa	bar
1.00	6.90	0.07	26.00	179.40	1.79	51.00	351.90	3.52	76.00	524.40	5.24
2.00	13.80	0.14	27.00	186.30	1.86	52.00	358.80	3.59	77.00	531.30	5.31
3.00	20.70	0.21	28.00	193.20	1.93	53.00	365.70	3.65	78.00	538.20	5.38
4.00	27.60	0.28	29.00	200.10	2.00	54.00	372.60	3.72	79.00	545.10	5.45
5.00	34.50	0.34	30.00	207.00	2.07	55.00	379.50	3.79	80.00	552.00	5.52
6.00	41.40	0.41	31.00	213.90	2.14	56.00	386.40	3.86	81.00	558.90	5.58
7.00	48.30	0.48	32.00	220.80	2.21	57.00	393.30	3.93	82.00	565.80	5.65
8.00	55.20	0.55	33.00	227.70	2.28	58.00	400.20	4.00	83.00	572.70	5.72
9.00	62.10	0.62	34.00	234.60	2.34	59.00	407.10	4.07	84.00	579.60	5.79
10.00	69.00	0.69	35.00	241.50	2.41	60.00	414.00	4.14	85.00	586.50	5.86
11.00	75.90	0.76	36.00	248.40	2.48	61.00	420.90	4.21	86.00	593.40	5.93
12.00	82.80	0.83	37.00	255.30	2.55	62.00	427.80	4.27	87.00	600.30	6.00
13.00	89.70	0.90	38.00	262.20	2.62	63.00	434.70	4.34	88.00	607.20	6.07
14.00	96.60	0.97	39.00	269.10	2.69	64.00	441.60	4.41	89.00	614.10	6.14
15.00	103.50	1.03	40.00	276.00	2.76	65.00	448.50	4.48	90.00	621.00	6.21
16.00	110.40	1.10	41.00	282.90	2.83	66.00	455.40	4.55	91.00	627.90	6.27
17.00	117.30	1.17	42.00	289.80	2.90	67.00	462.30	4.62	92.00	634.80	6.34
18.00	124.20	1.24	43.00	296.70	2.96	68.00	469.20	4.69	93.00	641.70	6.41
19.00	131.10	1.31	44.00	303.60	3.03	69.00	476.10	4.76	94.00	648.60	6.48
20.00	138.00	1.38	45.00	310.50	3.10	70.00	483.00	4.83	95.00	655.50	6.55
21.00	144.90	1.45	46.00	317.40	3.17	71.00	489.90	4.90	96.00	662.40	6.62
22.00	151.80	1.52	47.00	324.30	3.24	72.00	496.80	4.96	97.00	669.30	6.69
23.00	158.70	1.59	48.00	331.20	3.31	73.00	503.70	5.03	98.00	676.20	6.76
24.00	165.60	1.65	49.00	338.10	3.38	74.00	510.60	5.10	99.00	683.10	6.83
25.00	172.50	1.72	50.00	345.00	3.45	75.00	517.50	5.17	100.00	690.00	6.89

psi	kPa	bar
101.00	696.90	6.96
102.00	703.80	7.03
103.00	710.70	7.10
104.00	717.60	7.17
105.00	724.50	7.24
106.00	731.40	7.31
107.00	738.30	7.38
108.00	745.20	7.45
109.00	752.10	7.52
110.00	759.00	7.58
111.00	765.90	7.65
112.00	772.80	7.72
113.00	779.70	7.79
114.00	786.60	7.86
115.00	793.50	7.93
116.00	800.40	8.00
117.00	807.30	8.07
118.00	814.20	8.14
119.00	821.10	8.20
120.00	828.00	8.27
121.00	834.90	8.34
122.00	841.80	8.41
123.00	848.70	8.48
124.00	855.60	8.55
125.00	862.50	8.62

psi	kPa	bar
126.00	869.40	8.69
127.00	876.30	8.76
128.00	883.20	8.83
129.00	890.10	8.89
130.00	897.00	8.96
131.00	903.90	9.03
132.00	910.80	9.10
133.00	917.70	9.17
134.00	924.60	9.24
135.00	931.50	9.31
136.00	938.40	9.38
137.00	945.30	9.45
138.00	952.20	9.51
139.00	959.10	9.58
140.00	966.00	9.65
141.00	972.90	9.72
142.00	979.80	9.79
143.00	986.70	9.86
144.00	993.60	9.93
145.00	1000.50	10.00
146.00	1007.40	10.07
147.00	1014.30	10.14
148.00	1021.20	10.20
149.00	1028.10	10.27
150.00	1035.00	10.34

psi	kPa	bar
151.00	1041.90	10.41
152.00	1048.80	10.48
153.00	1055.70	10.55
154.00	1062.60	10.62
155.00	1069.50	10.69
156.00	1076.40	10.76
157.00	1083.30	10.82
158.00	1090.20	10.89
159.00	1097.10	10.96
160.00	1104.00	11.03



■ Appendix 4 – Measurement Conversion Table

Imperial system (inches)		Metric system (millimetres)			
Fraction	Thousandths of in	0-1 in	1-2 in	2-3 in	3-4 in
			25.40	50.80	76.20
1/64	0.015	0.397	25.80	51.20	76.60
1/32	0.031	0.794	26.19	51.59	76.99
3/64	0.046	1.191	26.59	51.99	77.39
1/16	0.062	1.588	26.99	52.39	77.79
5/64	0.078	1.984	27.38	52.78	78.18
3/32	0.093	2.381	27.78	53.18	78.58
7/64	0.109	2.778	28.18	53.58	78.98
1/8	0.125	3.175	28.58	53.98	79.38
9/64	0.140	3.572	28.97	54.37	79.77
5/32	0.156	3.969	29.37	54.77	80.17
11/64	0.171	4.366	29.77	55.17	80.57
3/16	0.187	4.763	30.16	55.56	80.96
13/64	0.203	5.159	30.56	55.96	81.36
7/32	0.218	5.556	30.96	56.36	81.76
15/64	0.234	5.953	31.35	56.75	82.15
1/4	0.250	6.350	31.75	57.15	82.55
17/64	0.265	6.747	32.15	57.55	82.85
9/32	0.281	7.144	32.54	57.94	83.34
19/64	0.296	7.541	32.94	58.34	83.74
5/16	0.312	7.938	33.34	58.74	84.14

Imperial system (inches)			Metric system (millimetres)			
Fraction		Thousandths of in	0-1 in	1-2 in	2-3 in	3-4 in
	21/64	0.328	8.334	33.73	59.13	84.53
	11/32	0.343	8.731	34.13	59.53	84.93
	23/64	0.359	9.128	34.53	59.93	85.33
3/8		0.375	9.525	34.93	60.33	85.73
	25/64	0.390	9.922	35.52	60.72	86.12
	13/32	0.406	10.319	35.72	61.12	86.52
	27/64	0.421	10.716	36.12	61.52	86.92
7/16		0.437	11.113	36.51	61.91	87.31
	29/64	0.453	11.509	36.91	62.31	87.71
	15/32	0.468	11.906	37.31	62.71	88.11
	31/64	0.484	12.303	37.70	63.10	88.50
1/2		0.500	12.700	38.10	63.50	88.90
	33/64	0.515	13.097	38.50	63.90	89.30
	17/32	0.531	13.494	38.89	64.29	89.69
	35/64	0.546	13.891	39.29	64.69	90.09
9/16		0.562	14.288	39.69	65.09	90.49
	37/64	0.578	14.684	40.08	65.48	90.88
	19/32	0.593	15.081	40.48	65.88	91.28
	39/64	0.609	15.478	40.88	66.28	91.68
5/8		0.625	15.875	41.28	66.68	92.08
	41/64	0.640	16.272	41.67	67.07	92.47



Imperial system (inches)		Metric system (millimetres)			
Fraction	Thousandths of in	0-1 in	1-2 in	2-3 in	3-4 in
21/32	0.656	16.669	42.07	67.47	92.87
43/64	0.671	17.066	42.47	67.87	93.27
11/16	0.687	17.463	42.86	68.26	93.66
45/64	0.703	17.859	43.26	68.66	94.06
23/32	0.718	18.256	43.66	69.06	94.46
47/64	0.734	18.653	44.05	69.45	94.85
3/4	0.750	19.050	44.45	69.85	95.25
49/64	0.765	19.447	44.85	70.25	95.65
25/32	0.781	19.844	45.24	70.64	96.04
51/64	0.796	20.241	45.64	71.04	96.44
13/16	0.812	20.638	46.04	71.44	96.84
53/64	0.828	21.034	46.43	71.83	97.23
27/32	0.843	21.431	46.83	72.23	97.63
55/64	0.859	21.828	47.23	72.63	98.03
7/8	0.875	22.225	47.63	73.03	98.43
57/64	0.890	22.622	48.02	73.42	98.82
29/32	0.906	23.019	48.42	73.82	99.22
59/64	0.921	23.416	48.82	74.22	99.62
15/16	0.937	23.813	49.21	74.61	100.01
61/64	0.953	24.209	49.61	75.01	100.41
31/32	0.968	24.606	50.01	75.41	100.81
63/64	0.984	25.003	50.40	75.80	101.20

■ Appendix 5 – Offences

Offences	Sections of the HSC ¹	Minimum Fine	Conduct Review Policy Points ²
Drivers			
Failing to conduct a circle check in accordance with prescribed standards	519.2	\$350	3
Failing to record observations in the circle check report	519.2	\$350	3
Driving a heavy vehicle for which a circle check has not been conducted	519.2.1	\$350	3
Driving a motor coach for which an inspection specific to motor coaches has not been conducted	519.2.2	\$350	3
Failing to complete, sign or update the circle check report	519.3	\$350	3
Failing to countersign the circle check report, when required	519.3	\$350	3
Possessing more than one report for the same circle check	519.3	\$350	3
Neglecting to send the circle check report to the proper party within the time prescribed by regulation	519.3	\$350	3
Failing to keep on board the vehicle the applicable defect lists, the circle check report or, if applicable, the motor coach inspection report	519.4	\$350	3
Refusing to surrender the defect lists, the circle check report or, if applicable, the motor coach inspection report to a peace officer	519.4	\$350	3
Driving a heavy vehicle without keeping the circle check report or, if applicable, the motor coach inspection report on board the vehicle	519.4.1	\$350	3
Failing to report a minor mechanical defect	519.5	\$175	2
Failing to report a major mechanical defect	519.5	\$350	3
Driving a heavy vehicle with a major mechanical defect	519.6	\$350	3

1. Highway Safety Code

2. Two policies provide for the weighting of offences: the *Conduct Review Policy for Heavy Vehicle Drivers* and the *Conduct Review Policy for Heavy Vehicle Owners and Operators*.

Offences	Sections of the HSC ¹	Minimum Fine	Conduct Review Policy Points ²
Operators			
Failing to ensure that a circle check has been conducted in accordance with prescribed standards	519.15.1	\$700	3
Allowing a heavy vehicle to be driven for which a circle check has not been conducted	519.15.2	\$700	3
Allowing a motor coach to be driven for which an inspection specific to motor coaches has not been conducted	519.15.2	\$700	3
Failing to place the applicable defect list in each heavy vehicle for which the operator is responsible	519.16	\$350	2
Failing to ensure that the driver keeps the defect list on board the vehicle	519.16	\$350	2
Failing to ensure that the driver keeps the circle check report or, if applicable, the motor coach inspection report on board the vehicle	519.16	\$350	2
Failing to ensure that the driver or the designated person enters all information in the circle check report	519.16	\$350	2
Allowing a heavy vehicle to be driven where the circle check report and, if applicable, the motor coach inspection report was not on board	519.16	\$700	3
Failing to inform the owner immediately of any defect observed by or brought to the attention of the operator	519.16	\$700	3
Failing to send the circle check report to the owner	519.16	\$700	3
Allowing a heavy vehicle that has a minor defect to be operated after 48 hours	519.17	\$350	2
Allowing a heavy vehicle that has a major defect to be operated	519.17	\$700	3

1. Highway Safety Code

2. Two policies provide for the weighting of offences: the *Conduct Review Policy for Heavy Vehicle Drivers* and the *Conduct Review Policy for Heavy Vehicle Owners and Operators*.

Offences	Sections of the HSC ¹	Minimum Fine	Conduct Review Policy Points ²
Owners³			
Failing to maintain one's vehicles in good mechanical order	519.15	\$700	3
Failing to conduct an inspection specific to motor coaches	519.15	\$700	3
Failing to fill out the motor coach inspection report	519.15	\$700	3
Failing to leave the motor coach inspection report in the motor coach	519.15	\$700	3
Allowing a heavy vehicle that has a minor defect to be operated after 48 hours	519.17	\$350	2
Allowing a heavy vehicle that has a major defect to be operated	519.17	\$700	3
Failing to obtain a copy of the circle check report of the vehicle used by an operator	519.18	\$700	3

1. Highway Safety Code

2. Two policies provide for the weighting of offences: the *Conduct Review Policy for Heavy Vehicle Drivers* and the *Conduct Review Policy for Heavy Vehicle Owners and Operators*.

3. For owners, a statement of offence is only assigned a weighting if it is served during a facility audit.



Glossary

170

Adequate	Appropriate to its function and constantly kept in good working order (s. 5, RRSSRV)
AROODHV	Act respecting owners, operators and drivers of heavy vehicles
Bus	Motor vehicle, other than a minibus, designed for the transportation of more than nine occupants at a time and used mainly for that purpose or equipped with devices to secure wheelchairs against movement (s. 4, HSC)
Combination of road vehicles	Combination of vehicles consisting of a motorized road vehicle drawing a trailer, a semi-trailer or a detachable axle (s. 4, HSC)
Construction trailer	Closed trailer used principally as an office, as a warehouse, or as sleeping or resting quarters and equipped with a drawbar but no kingpin (s. 2, RRSSRV)
Emergency vehicle	Road vehicle used as a police car in accordance with the <i>Police Act</i> (chapter P-13.1), a road vehicle used as an ambulance in accordance with the <i>Act respecting pre-hospital emergency services</i> (chapter S-6.2), a fire safety vehicle, or any other road vehicle which meets the criteria established by regulation for recognition as an emergency vehicle by the Société (s. 4, HSC)
Equipment transport vehicle	Road vehicle with a net weight of more than 3,000 kg used solely for the transportation of machinery with which it is permanently equipped and its accessories. Emergency vehicles and vehicles that are used or can be used for the transportation of other goods are excluded from this definition (s. 2, RRRVR)
Farm machinery	Equipment, whether motorized or not, designed and used solely for agricultural purposes (s. 2, RRRVR)
Farm tractor	Farm machine equipped with pneumatic tires or rubber caterpillar tracks that is designed to draw farm equipment and owned by a farmer who uses it for any purpose whatever or used for personal ends by an owner who is a natural person other than a farmer (s. 2, RRRVR)

Farm trailer	Road vehicle equipped with a drawbar to which a towing coupling device is attached that may be hitched to the coupling device of the towing vehicle with a tow pin and used for the transportation of unprocessed timber, farm products or materials or matters required in their production (s. 2, RRSSRV)
Fire department road vehicle	Emergency vehicle belonging to a fire department (s. 2, RRSSRV)
Heavy vehicle	<ul style="list-style-type: none"> • A road vehicle, within the meaning of the HSC, with a GVWR of 4,500 kg or more • A combination of road vehicles (within the meaning of the HSC), that includes at least one vehicle with a GVWR of 4,500 kg or more • A bus, minibus or tow truck (within the meaning of the HSC) • A road vehicle that is subject to the <i>Transportation of Dangerous Substances Regulation</i>
Heavy vehicle operator	Person who controls the operation of a heavy vehicle (s. 2, AROODHV)
Heavy vehicle owner	Person whose name appears on the vehicle's registration issued in Québec and person who leases a heavy vehicle for a period of not less than one year (s. 2, AROODHV; s. 2 HSC)
HSC	Highway Safety Code
Minibus	Motor vehicle having two axles with single wheels and equipped with not more than five rows of seats for the transportation of more than nine occupants at a time, or equipped with devices to secure wheelchairs against movement (s. 4, HSC)
Motor coach	Bus of monocoque design, manufactured to provide intercity, suburban, commuter or charter service and equipped with under-floor baggage storage, a pneumatic suspension, pneumatic brakes and automatic brake play adjusters (s. 2, RRSSRV)



Motor home	Motor vehicle permanently converted into a dwelling (s. 2, RRSSRV)
Road vehicle	Motor vehicle that can be driven on a highway, other than a vehicle that runs only on rails, a power-assisted bicycle or an electrically propelled wheelchair; a trailer, a semi-trailer or a detachable axle is defined as a road vehicle (s. 4, HSC)
RRRVR	Regulation respecting road vehicle registration
RRSSRV	Regulation respecting safety standards for road vehicles
School bus	Bus or minibus used to carry schoolchildren (s. 2 RRSSRV)
Tool vehicle	Road vehicle, other than a vehicle mounted on a truck chassis, manufactured to perform work and the work station of which is an integral part of the driver's compartment. For the purposes of this definition, a truck chassis is a frame equipped with all the mechanical components required on a road vehicle designed for the transportation of persons, goods or equipment (s. 4, HSC)
Tow truck	Motor vehicle equipped to lift and tow a road vehicle or to load a road vehicle onto its platform (s. 4, HSC)
Vehicle engaged in the transportation of schoolchildren	Road vehicle other than a bus engaged in the transportation of schoolchildren that may be used on occasion or full time to carry schoolchildren, and that is operated by a school board or by a private educational institution, or under the terms of a contract with a school board exercising authority in connection with the transportation of schoolchildren pursuant to sections 291 to 299 of the <i>Education Act</i> (chapter I-13.1) or under sections 195 and 431 to 431.8 of the <i>Education Act for Cree, Inuit and Naskapi Native Persons</i> (chapter I-14), or with a private educational institution authorized to organize the transportation of students under section 62 of the <i>Act respecting private education</i> (chapter E-9.1) (s. 2, RRSSRV)

*Société de l'assurance
automobile*

Québec 